

Servo motors

MQA asynchronous servo motor

DRAFT

Contents

About this document	4
Document description	4
Further documents	4
Notations and conventions	5
Safety instructions	6
Basic safety instructions	6
Application as directed	6
Residual hazards	7
Product information	8
Identification of the products	8
Nameplates	8
Product codes	9
Equipment	11
Transport	12
Storage	13
Mechanical installation	14
Important notes	14
Preparation	14
Installation	14
Dimensions	14
Mounting	15
Electrical installation	16
Important notes	16
Preparation	16
Motor connection	17
Connection via terminal box	17
Connection via ICN connector	19
Commissioning	24
Important notes	24
Before initial switch-on	24
Functional test	24
Maintenance	25
Repair	26
Diagnostics and fault elimination	27
Malfunctions	27
Technical data	28
Standards and operating conditions	28
Conformities and approvals	28
Protection of persons and device protection	28
EMC data	28
Environmental conditions	29
Rated data	30
Inverter power supply 400 V, forced ventilated motors	30
Environmental notes and recycling	32

About this document

Document description

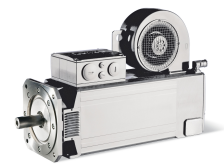

About this document

WARNING!

Read this documentation carefully before starting any work.

- ▶ Please observe the safety instructions!
-

Document description

This document is intended for skilled personnel who work with the products described.

The data and information compiled in this document serve to support you in the electrical and mechanical installation and commissioning.

- The document is only valid together with the complete documentation of the product!
- For safety-rated attachments observe the enclosed operating instructions of the manufacturer!
- The document includes safety instructions which must be observed.
- All persons working on and with the drives must have the documentation at hand during work and observe the information and notes relevant for it.
- The documentation must always be complete and in a perfectly readable state.

Further documents







Information and tools with regard to the Lenze products can be found on the Internet:

www.Lenze.com → Downloads



Notations and conventions

Conventions are used in this document to distinguish between different types of information.

Numeric notation		
Decimal separator	Point	Generally shown as a decimal point. Example: 1 234.56
Warnings		
UL Warnings	UL	Are used in English and French.
UR warnings	UR	
Text		
Engineering Tools	" "	Software Example: "Engineer", "EASY Starter"
Icons		
Page reference		Reference to another page with additional information. Example:  16 = see page 16
Documentation reference		Reference to other documentation with additional information. Example:  EDKxxx = see documentation EDKxxx

Layout of the safety instructions

DANGER!

Indicates an extremely hazardous situation. Failure to comply with this instruction will result in severe irreparable injury and even death.

WARNING!

Indicates an extremely hazardous situation. Failure to comply with this instruction may result in severe irreparable injury and even death.

CAUTION!

Indicates a hazardous situation. Failure to comply with this instruction may result in slight to medium injury.

NOTICE

Indicates a material hazard. Failure to comply with this instruction may result in material damage.

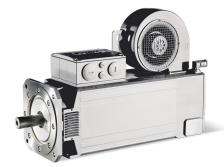

Safety instructions

Basic safety instructions

Disregarding the following basic safety instructions and safety information may lead to severe personal injury and damage to property!

- Only use the product as directed.
- Never commission the product in the event of visible damage.
- Never modify the product technically.
- Never commission the product before assembly has been completed.
- Never operate the product without the required covers.
- Connect/disconnect all pluggable connections only in deenergized condition!
- Only remove the product from the installation in the deenergized state.
- The product can – depending on their degree of protection – have live, movable or rotating parts during or after operation. Surfaces can be hot.
- Observe all specifications of the corresponding documentation supplied. This is the condition for safe and trouble-free operation and the achievement of the specified product features.
- The procedural notes and circuit details given in the associated documentation are suggestions and their transferability to the respective application has to be checked. The manufacturer of the product does not take responsibility for the suitability of the process and circuit proposals.
- All work with and on the product may only be carried out by qualified personnel. IEC 60364 and CENELEC HD 384 define the qualifications of these persons:
 - They are familiar with installing, mounting, commissioning, and operating the product.
 - They have the corresponding qualifications for their work.
 - They know and can apply all regulations for the prevention of accidents, directives, and laws applicable at the place of use.

Application as directed

- The product is a professional equipment intended for use by trades, specific professions or industry and not for sale to the general public. IEC 60050 [IEV 161-05-05]
- To prevent personal injury and damage to property, higher-level safety and protection systems must be used!
- All transport locks must be removed.
- Mounted eye bolts on the motor are not suitable for transporting geared motors.
- The product may only be operated under the specified operating conditions and in the specified mounting positions.
- The product may only be operated on the inverter.
- Built-in brakes must not be used as safety brakes.
- The product must not be operated in private areas, in potentially explosive atmospheres and in areas with harmful gases, oils, acids and radiation.



Residual hazards

Even if notes given are taken into consideration and protective measures are implemented, the occurrence of residual risks cannot be fully prevented.

The user must take the residual hazards mentioned into consideration in the risk assessment for his/her machine/system.

If the above is disregarded, this can lead to severe injuries to persons and damage to property!

Product

Observe the warning labels on the product!



Dangerous electrical voltage:

Before working on the product, make sure there is no voltage applied to the power terminals! After mains disconnection, the power terminals will still carry the hazardous electrical voltage for the time given next to the symbol!



High leakage current:

Carry out fixed installation and PE connection in compliance with:
EN 61800-5-1 / EN 60204-1



Hot surface:

Use personal protective equipment or wait until the device has cooled down!

Protection of persons

- The power terminals may carry voltage in the switched-off state or when the motor is stopped.
 - Before working, check whether all power terminals are deenergized.
- Voltages may occur on the drive components (e.g. capacitive, caused by inverter supply).
 - Careful earthing in the marked positions of the components must be carried out.
- There is a risk of burns from hot surfaces.
 - Provide protection against accidental contact.
 - Use personal protective equipment or wait until the device has cooled down.
 - Prevent contact with flammable substances.
- There is a risk of injury due to rotating parts.
 - Before working on the drive system, ensure that the motor is at a standstill.
- There is a risk of accidental start-up or electric shock.

Motor protection

- Installed temperature sensors are no full protection for the machine.
 - If necessary, limit the maximum current. Parameterize the inverter so that it will be switched off after some seconds of operation with $I > I_{rated}$, especially if there is a risk of blocking.
 - Integrated overload protection does not prevent overloading under all conditions.
- The fuses are no motor protection.
 - Use a current-dependent motor protection switch.
 - Use the built-in temperature sensors.
- Too high torques cause a fraction of the motor shaft.
 - Do not exceed the maximum torques according to the technical data on the nameplate.
- Lateral forces on the motor shaft are possible.
 - Align the shafts of motor and driven machine exactly to each other.

Product information

Identification of the products
Nameplates

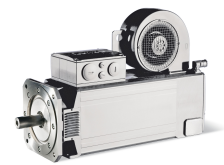

Product information

Identification of the products

Nameplates

Asynchronous servo motors

Lenze				
1		15		
2	4			
5.5	5.8	5.2	5.4	5.3
5.6	5.9	5.10	5.11	22
5.7	14.2	14.1	27	14.3
9			12	
8				
10.2/10.3		18	11	

Pops.	Contents
1	Manufacturer / production location
2	Motor type
4	Motor type
5	Technical data
5.2	Rated torque
5.3	Rated speed
5.4	Rated frequency
5.5	Rated voltage
5.6	Rated current
5.7	Maximum current
5.8	Rated power [kW]
5.9	Rated power [HP]
5.10	Continuous standstill torque
5.11	Power factor cos φ
8	Brake data
	Type, supply voltage, electrical power consumption, braking torque
9	Feedback
10	Production data
10.2	Material number
10.3	Serial number
11	Bar code
12	Motor number
14	Additional motor specifications
14.1	Temperature class
14.2	Degree of protection
14.3	Motor protection
15	Applicable conformities, approvals and certificates
18	Year of manufacture / week of manufacture
22	C86 = motor code for controller parameterization (code 0086)
27	Permissible ambient temperature (e.g. Ta < 40°C)



Product information

Identification of the products
Product codes

Product codes

Product code of MQA asynchronous servo motor

Example		M	Q	A	20	L	14	-	RS0	B0
Meaning	Variant	Product code								
Product family	Motor	M								
Type	Compact servo motors		Q							
Variant	Asynchronous			A						
Motor frame size	Square dimension 200 mm				20					
	Square dimension 220 mm				22					
	Square dimension 260 mm				26					
Overall length						L P T				
Rated speed	rpm x 100						05 ... 29			
Inverter mains connection	3 x 400 V								H	
Feedback	SinCos absolute value encoder, single-turn, EnDat AS2048-5V-E									ECN
	SinCos absolute value encoder, multi-turn, EnDat AM32-5V-E									EQI
	SinCos absolute value encoder, multi-turn, EnDat AM2048-5V-E									EQN
	Resolver									RS0
	Safety resolver RV03									RV0
	SinCos safety incremental encoder, single-turn IG1024-5V-V3									S1S
	SinCos incremental encoder, single-turn IG2048-5V-S									S20
	SinCos absolute value encoder, multi-turn, Hiperface® AM1024-8V-H									SRM
	SinCos absolute value encoder, single-turn, Hiperface® AS1024-8V-H									SRS
	TTL incremental encoder IG2048-5V-T									T20
TTL incremental encoder IG4096-5V-T									T40	
Brake	Without brake									B0
	Spring-applied brake DC 24 V									F1
	Spring-applied brake DC 24 V, reinforced									F2
	Spring-applied brake AC 230 V									FG
	Spring-applied brake AC 230 V, reinforced									FH

Product information

Identification of the products
Product codes

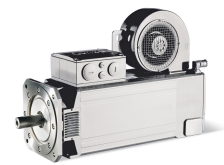

Product code feedbacks

Example	AS	1024	-	8 V	-	K	2	
Meaning	Variant	Product code						
Product family	Resolver	RS						
	Resolver for safety function	RV						
	Incremental encoder	IG						
	Incremental encoder with commutation signal	IK						
	Absolute value encoder, singleturn	AS						
	Absolute value encoder, multiturn	AM						
Number	2-pole Resolver for servo motors		0					
	2-pole Resolver for three-phase AC motors		1					
	Number of pole pairs for resolvers		2					
			3					
			4					
		...						
Number of bits, steps or increments per revolution		20						
		32						
		128						
		512						
		1024						
		2048						
		...						
Supply voltage				5 V 8 V 15 V 24 V ...				
Interface or signal level	Standard							
	TTL					T		
	HTL (for incremental encoders)					H		
	Hiperface (for absolute value encoders)					H		
	EnDat					E		
	SinCos 1 Vss					S		
	Digital					D		
	For safety function							
	TTL						U	
	HTL (for incremental encoders)						K	
	Hiperface (for absolute value encoders)						K	
	EnDat						F	
	SinCos 1 Vss						V	
	Digital						D	
	Safety Integrity Level (SIL)							1 2 3 4

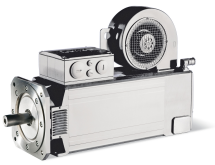

Equipment

The following figure provides an overview of the elements and connections on the product. Their position, size and appearance may vary.

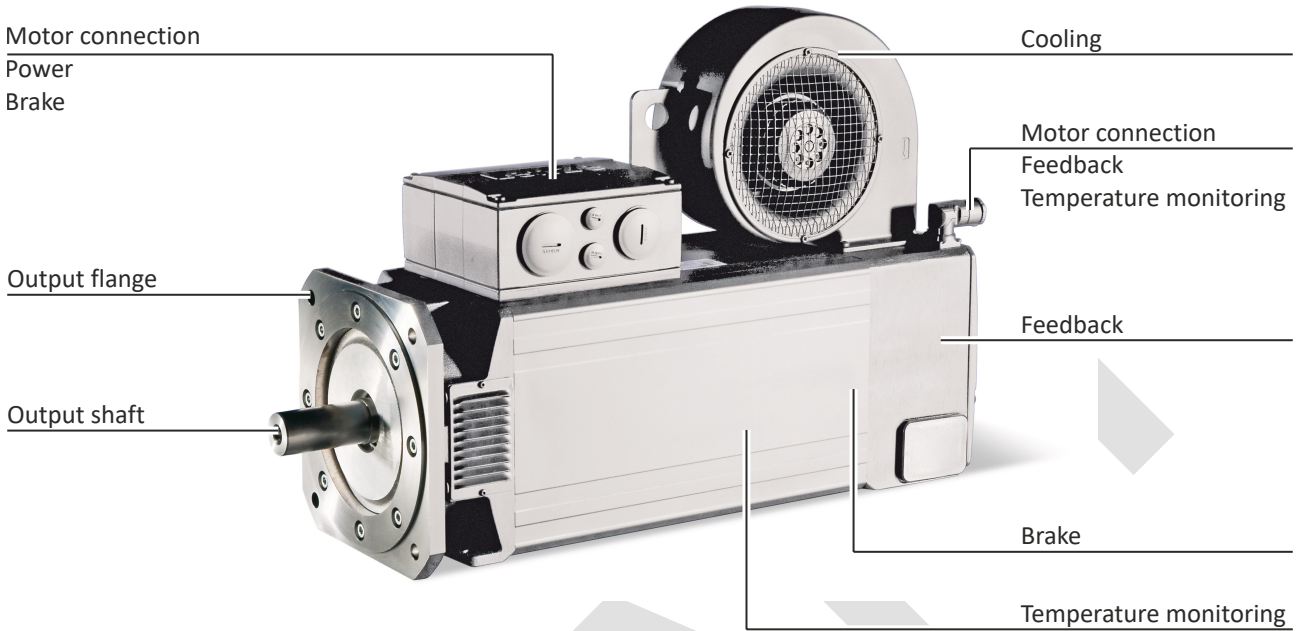

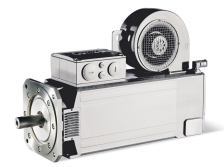

Transport

- Ensure appropriate handling.
- Make sure that all component parts are securely mounted. Secure or remove loose component parts.
- Only use safely fixed transport aids (e.g., eye bolts or support plates).
- Do not damage any components during transport.
- Avoid electrostatic discharges on electronic components and contacts.
- Avoid impacts.
- Check the carrying capacity of the hoists and load handling devices. The weights can be found in the shipping documents.
- Secure the load against tipping and falling down.
- Standing beneath suspended loads is prohibited.

DRAFT



Storage

Storage up to one year:

- If possible, in the manufacturer's packaging
- In dry, low-vibration environment without aggressive atmosphere
- Protect against dust and impacts
- Observe the climatic conditions according to the technical data
 - [▶ Environmental conditions](#)  29

DRAFT

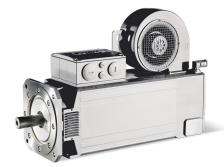

Mechanical installation

Important notes

- Install the product according to the information in the chapter "Standards and operating conditions".
 - ▶ [Standards and operating conditions](#) 28
- The technical data and the data regarding the supply conditions can be found on the nameplate and in this documentation.
- Ambient media – especially chemically aggressive ones – may damage shaft sealing rings, lacquers and plastics.
- Lenze offers special surface and corrosion protection in this case.

Preparation

- Protect shaft sealing rings from contact with solvents.
- Remove protection covers from shafts.
- Thoroughly remove anticorrosion agents from the shaft and from flange faces.
- Draw the transmission elements onto the output shaft only by using the centering thread.
- Align the output shaft and transmission elements exactly to avoid tensions.
- Mount belt pulleys, sprockets, or gear wheels as close as possible to the shaft shoulder in order to keep the bending load of the shaft and the bearing forces at a minimum level.
- Tighten all screw connections with the specified torques and secure them with standard screw locking adhesive.
- Check paint for damage and repair professionally.

Installation

- The mounting surfaces must be plane, torsionally rigid and free from vibrations.
- The mounting areas must be suited to absorb the forces and torques generated during operation.
- Ensure an unhindered ventilation.
- For versions with a fan, keep a minimum distance of 10 % from the outside diameter of the fan cover in intake direction.

Dimensions



Dimensions are contained in the configuration document.



Mounting

Transmission elements

- Fit or remove transmission elements only using suitable equipment.
- For fitting the transmission elements use the center hole in the shaft.
- Avoid impacts and shocks.
- In case of a belt drive, tension the belt in a controlled manner according to manufacturer information.
- Be sure to carry out mounting in a manner free from distortion.
- Compensate minor inaccuracies by suitable flexible couplings.

Fastening

- Use screws with a minimum property class of 8.8.
- Observe prescribed tightening torques.
- Secure against unintended loosening.
- For alternating loads, we recommend applying anaerobic curing adhesive between flange and mounting surface.

Thread		M3	M4	M5	M6	M8	M10	M12	M16	M20	M24	M27	M30
Strength		Tightening torque Nm $\pm 10\%$											
8.8	Nm	1.3	3.0	5.9	10.1	24.6	48	84	206	415	714	1050	1428
10.9	Nm	1.9	4.6	8.6	14.9	36.1	71	123	302	592	1017	1496	2033

DRAFT

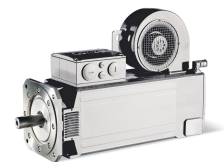

Electrical installation

Important notes

DANGER!

Risk of injury and risk of burns from dangerous voltage

Power terminals may also carry voltage in the switched-off state or when the motor is stopped and may cause life-threatening cardiac arrhythmia and serious burns.

- ▶ Disconnect the product from the mains.
- ▶ Check that the power terminals are deenergized before starting work.

- When working on energized products, comply with the applicable national accident prevention regulations.
- The electrical installation must be carried out according to the appropriate regulations (e.g. cable cross-sections, fuses, PE connection).
- The manufacturer of the system or machine is responsible for adherence to the limits required in connection with EMC legislation.

Operation on an external inverter

A max. pulse voltage amplitude of $U_{pk} = 1560 \text{ V}$ at the motor terminals must not be exceeded.

Here, the minimum pulse rise time must be $t_R = 0.1 \mu\text{s}$.

If it cannot be ruled out that the permissible voltage peaks will be exceeded or that the minimum pulse rise time will not be reached, the following measures must be initiated:

- Reduction of the DC-bus voltage (threshold for brake chopper voltage)
- Use of filters, chokes
- Use of special motor cables

Preparation



The notes for the electrical connection can be found in the enclosed mounting instructions.

EMC-compliant wiring



The EMC-compliant wiring is described in detail in the documentation of the Lenze inverters.



Motor connection

Connection via terminal box

Observe the notes on wiring, data on the nameplate, and the connection diagram in the terminal box.

The connection must ensure a continuous and safe electrical supply:

- No protruding wire ends
- Use assigned cable end fittings
- Ensure good electrical conductivity of the contact (remove paint residues) if an additional PE connection is used
- Establish a safe protective earth connection
- After the connection is completed, make sure that all connections on the terminal board are firmly tightened
- The terminal box has to be free of foreign bodies, dirt, and humidity
- All unused cable entries and the terminal box itself must be sealed so that they are dust-tight and waterproof

The smallest air gaps between uncoated, live parts and against earth must not fall below the following values:

Minimum requirements for basic insulation according to IEC/EN 60664-1 (CE)	Higher requirements for UL design	Motor diameter
3.87 mm	6.4 mm	<178 mm
	9.5 mm	> 178 mm

Position of the connections

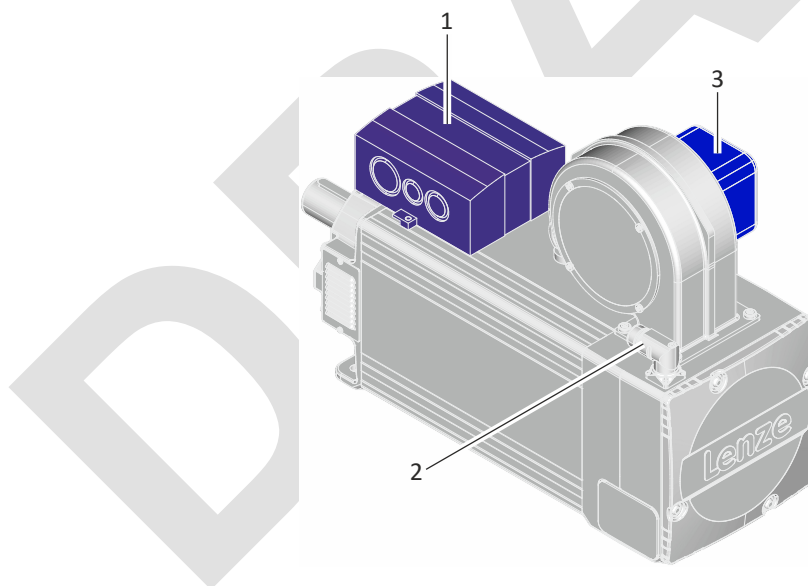

Position	Meaning
1	Power connection Brake connection PE connection
2	Feedback connection Connection of temperature monitoring
3	Blower connection

Electrical installation

Motor connection
Connection via terminal box

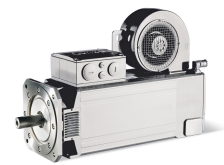

Cable glands



The cut-outs for the cable glands are closed with sealing plugs.

The cable glands are arranged on both sides with MQA20.

The cable glands are arranged on one side with MQA22 and MQA26. If required, the terminal box can be rotated by 180 ° after loosening the screws in the terminal box.

Motor		MQA20	MQA22	MQA26
Screwed connections		2x M20 x 1.5 2x M25 x 1.5 2x M32 x 1.5	1x M40 x 1.5 1x M50 x 1.5 1x M20 x 1.5 1x M16 x 1.5	1x M50 x 1.5 1x M63 x 1.5 1x M20 x 1.5 1x M16 x 1.5
Cable cross-section	mm ²	2.5 ... 16	10 ... 35	-
Terminal design		Spring-loaded terminal	Screw terminal	Threaded bolt
Stripping length	mm	18 ... 20	18	-
Threaded bolt		-	-	M12
Tightening torque	Nm	-	3.2	15.5

Terminal box, power		
Contact	Name	Meaning
U1	L1	Motor winding phase
V1	L2	
W1	L3	
PE	PE	PE conductor

Terminal box, DC brake		
Contact	Name	Meaning
BD1	+	Brake +
BD2	-	Brake -

Terminal box, AC brake		
Contact	Name	Meaning
~	L1	Mains
	N	
+	+	Holding brake (factory-wired)
-	-	
Schalter		Switching contact - DC switching

Terminal box with temperature monitoring R		
Contact	Name	Meaning
R1	+	Temperature sensor +
R2	-	Temperature sensor -

Terminal box, 1-phase separate fan		
Contact	Name	Meaning
PE	PE	PE conductor
U1	L1	Mains
U2	N	

Terminal box, 3-phase separate fan		
Contact	Name	Meaning
PE	PE	PE conductor
U1	L1	Mains connection
V1	L2	
W1	L3	

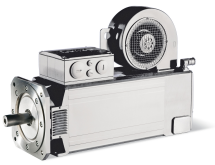

Electrical installation

Motor connection
Connection via ICN connector

Connection via ICN connector

Position of the connections

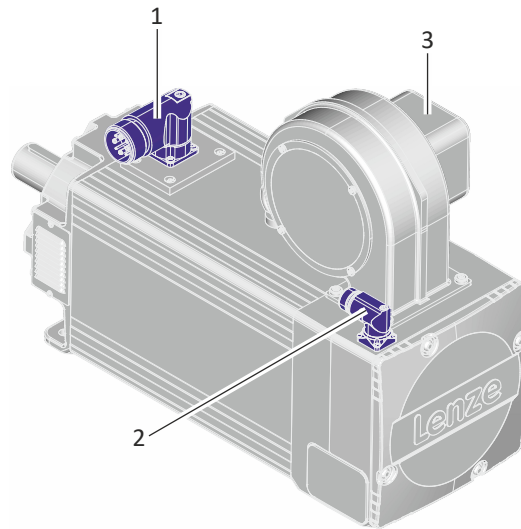

Position	Meaning
1	Power connection Brake connection PE connection
2	Feedback connection Connection of temperature monitoring
3	Blower connection

DRAFT

Electrical installation

Motor connection

Connection via ICN connector

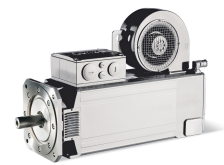

Power and brake connection

Valid for MQA20

ICN-M40 connector assignment

8-pole

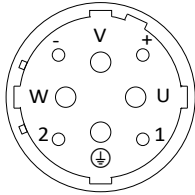

ICN M40 8-pole		
Contact	Name	Meaning
+	BD1	Holding brake +
-	BD2	Holding brake -
PE	PE	PE conductor
U	U	Power phase U
V	V	Power phase V
W	W	Power phase W
1		Not assigned
2		Not assigned

DRAFT



Feedback and temperature monitoring connection

ICN-M23 connector assignment

Resolver

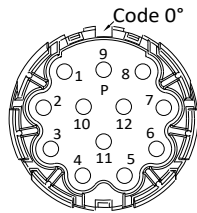

ICN M23 for resolvers		
Contact	Name	Meaning
1	+Ref	Transformer windings
2	-Ref	Transformer windings
3	+VCC ETS	Supply: Electronic nameplate (Only for motors and inverters that support this function)
4	+COS	Cosine stator windings
5	-COS	Cosine stator windings
6	+SIN	Sine stator windings
7	-SIN	Sine stator windings
8		Not assigned
9		Not assigned
10	Schirm	Encoder housing shield
11	+	Temperature monitoring: PT1000
12	-	Temperature monitoring: PT1000

ICN-M23 connector assignment

Incremental and SinCos absolute value encoder Hiperface©

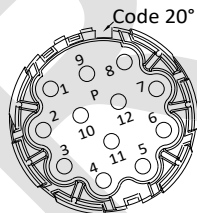

ICN M23 for incremental and SinCos absolute value encoder Hiperface		
Contact	Name	Meaning
1	B	Track B / + SIN
2	A ⁻	Track A inverse /- COS
3	A	Track A / + COS
4	+UB	Supply +
5	GND	Mass
6	Z ⁻	Zero track inverse /-RS485
7	Z	Zero track / + RS485
8		Not assigned
9	B ⁻	Track B inverse/-SIN
10	Schirm	Encoder housing shield
11	+	Temperature monitoring: PT1000
12	-	Temperature monitoring: PT1000

Electrical installation

Motor connection

Connection via ICN connector

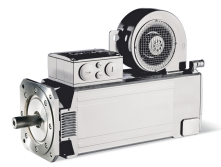

ICN-M23 connector assignment

SinCos absolute value encoder with EnDat interface

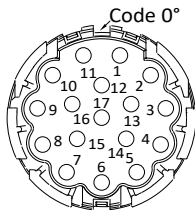

ICN M23 SinCos absolute value encoder with EnDat		
Contact	Name	Meaning
1	UP Sensor	Up Sensor
2		Not assigned
3		Not assigned
4	0 V Sensor	0 V sensor
5	+	PT1000/KTY temperature sensor
6	-	PT1000/KTY temperature sensor
7	+UB	Supply +
8	Takt	EnDat interface cycle
9	Takt-	Inverse EnDat interface cycle
10	GND	Mass
11	Schirm	Encoder housing shield
12	B	Track B
13	B-	Track B inverse/-SIN
14	Daten	EnDat interface data
15	A	Track A
16	A-	Track A inverse /- COS
17	Daten-	Data inverse EnDat interface



Assembly of ICN connectors

NOTICE

Live cables!

Possible destruction of the connector.

- ▶ Never remove connector when voltage is being applied!
- ▶ Disable inverter before removing the connector!

NOTICE

Loss of the protection class due to incorrect mounting!

Malfunctions may occur.

- ▶ ICN connector with screwed connection: Do not remove O-ring
- ▶ ICN connector with bayonet lock: remove O-ring and dispose of it.

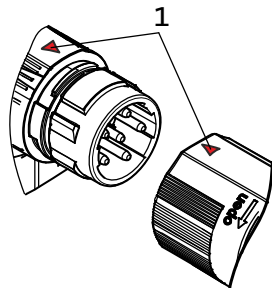

1. When connecting the connector to the motor connector, make sure that the aids to orientation (pos. 1) are facing each other.
2. Tighten the box nut of the connector!

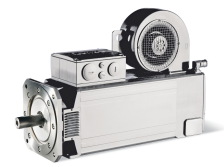

Commissioning

Important notes

NOTICE

Do not brake the motor by short-circuit operation.

Short-circuit braking may damage the motor.

Before initial switch-on

- That the drive does not show any visible signs of damage.
- Is the mechanical fixing o.k.?
- Is the electrical connection ok?
- Are all rotating parts and surfaces that may become hot protected against contact?
- Is the featherkey radially secured during the test run without output elements?
- Have all screwed connections of the mechanical and electrical parts been tightened?
- Is it ensured that the cooling air can be freely supplied and discharged?
- Has the PE conductor been connected correctly?
- Are the protective devices against overheating (e.g. thermal sensor evaluation) working?
- Has the inverter been parameterized suitably for the motor?
- Is the phase sequence of the motor connection correct?
- Is the contact of good electrical conductivity if a PE connection on the motor housing is used?

After a long period of downtime or after overhauling the motor, check the insulation resistance prior to initial switch-on, as condensation may have formed.

- If the values measured are $\leq 1 \text{ k}\Omega$ per volt of the rated voltage, the insulation resistance is inadequate and no voltage is to be applied.
- Dry the winding until the insulation resistance is $> 1 \text{ k}\Omega$ per volt of the rated voltage.

Functional test

After commissioning, check all individual functions of the drive:

- Rotating direction in decoupled state
- Torque behavior and current consumption
- Function of the feedback system
- Brake function

During operation, carry out inspections on a regular basis. Pay special attention to:

- Unusual noises
- Irregular running
- Increased vibration
- Loose fixing elements
- Condition of electrical cables
- Speed variations
- Deposits on the drive and in the cooling channels



Maintenance

⚠ WARNING!

Risk of injury due to non-compliance with the following safety measures

Disregarding the following safety measures may lead to severe personal injury and damage to property.

- ▶ Only work on the drive system when it is de-energised.
- ▶ Wait for the surfaces to cool down.
- ▶ Put the drive system in a load-free state or secure any loads acting on the drive.
- ▶ Protect the motors against the ingress of foreign bodies.

-
- Clean surfaces regularly
 - If equipped with blower: clean the air inlets regularly

Brake

- The brakes are not accessible from the outside.
- Maintenance work of the brake must only be carried out by Lenze Service personnel.

Feedback

⚠ WARNING!

Functional safety

Certain feedback systems support safety functions according to the requirements of the 2006/42/EC: Machinery Directive [UKCA: S.I. 2008/1597 - The Supply of Machinery (Safety) Regulations 2008] .

Any work on the safety encoder which has not been executed professionally will cause a loss of the safety functions.

- ▶ The safety encoder may only be repaired or replaced by the Lenze service or its authorised persons.

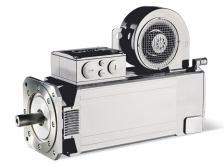

Repair

NOTICE

We recommend having all repairs carried out by the Lenze service department.

If faults occur during the operation of the drive system:

- First check the possible causes of malfunction according to the [► Diagnostics and fault elimination](#)  27
- If the fault cannot be remedied using one of the measures listed, please contact the Lenze service department. The contact data can be found on the rear of this documentation.

DRAFT



Diagnostics and fault elimination

Malfunctions

If faults occur during the operation of the drive, the table below helps you to identify the causes. If it is not possible to remedy the fault using the measures listed, please contact the Lenze service department.

Error	Possible causes	Remedy
Motor too hot Can only be evaluated by measuring the surface temperature: <ul style="list-style-type: none"> • Non-ventilated motors >140 °C • Externally ventilated or self-ventilated motors > 110 °C 	Insufficient cooling air, blocked air ducts.	Ensure unimpeded circulation of cooling air
	Preheated cooling air	Ensure a sufficient supply of fresh cooling air
	Overload, with normal mains voltage the current is too high and the speed too low	Use larger drive (determined by power measurement)
	Rated operating mode (S1 to S8 IEC/EN 60034-1) exceeded	Adjust rated operating mode to the specified operating conditions. Determination of correct drive by expert or Lenze customer service
	Loose contact in supply cable (temporary single-phase operation!)	Tighten loose contact
	Fuse has blown (single-phasing!)	Replace fuse
	Overload of the drive	Check load and, if necessary, reduce by means of longer ramp-up times Check winding temperature
	Heat dissipation impeded by deposits	Clean surface and cooling fins of the drives
	Heat dissipation hindered by thermally insulated attachment	Note the cooling effect of the mounting flange during project planning
Motor suddenly stops and does not restart	Overload monitoring of the inverter is activated	Check inverter settings
		Reduce load caused by longer acceleration times
Incorrect direction of rotation of the motor, correct display on the inverter	Motor cable with reverse polarity	Check and correct polarity
	Polarity of encoder cable reversed	
Motor rotates normally but does not reach the expected torque	Motor cable interchanged cyclically Not all motor phases connected	Connect the phases at the motor cable connection correctly
Motor turns in one direction at maximum speed in an uncontrolled manner	Motor cable interchanged cyclically	Check motor connection and, if necessary, correct
	Polarity of encoder cable reversed	Check encoder connection and, if necessary, correct
Motor slowly rotates in one direction and is not influenced by the inverter	Polarity of motor cable and encoder cable reversed	Check and correct polarity
Irregular running	Insufficient shielding of motor or resolver cable	Checking shielding and earth connection
	Inverter gain too large	Adjust the gains of the controllers (see operating instructions for the inverter)
Vibrations	Insufficiently balanced coupling elements or machine	Rebalance
	Inadequate alignment of drive train	Realign machine unit, check foundation, if necessary.
	Loose fixing screws	Check and tighten screw connections
Running noises	Foreign particles inside the motor	Repair by the manufacturer, if necessary
	Bearing damage	

Technical data

Standards and operating conditions
Conformities and approvals

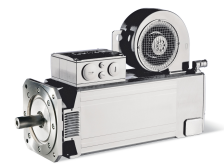

Technical data

Standards and operating conditions

Conformities and approvals

More information and certificates of approval can be found under

[MQA asynchronous servo motors \(Lenze.com\)](http://MQA.asynchronous.servo.motors(Lenze.com))

Europa		
Country	Conformity/approval	Product representation
European Union	CE	CE mark
Eurasian Economic Union (EAC)	EAC	EAC mark
Great Britain	UKCA	UKCA mark

America		
Country	Conformity/approval	Product representation
Canada	CSA	cURus mark
USA	UL	

Asia		
Country	Conformity/approval	Product representation
China	-	EFUP mark

Protection of persons and device protection

Protection class			
-	EN IEC 60529, EN IEC 60034-5	IP23S	

Temperature class			
-	EN IEC 60034-1	F (155 °C)	Insulation system

Permissible voltage			
-	IEC 60034-18-41	IVIC C	At 500 V
	IEC/TS 60034-25:2007	Limit curve A	Of the pulse voltage

EMC data

Noise emission		
-	EN IEC 60034-1	A final overall assessment of the drive system is indispensable

Noise immunity		
-	EN IEC 60034-1	A final overall assessment of the drive system is indispensable



Environmental conditions

Climate			
Storage	EN 60721-3-1:1997	1K3 (-20 ... +40 °C)	>3 months
		1K3 (-20 ... +60 °C)	<3 months
Transport	EN 60721-3-2:1997	2K3 (-20 ... +70 °C)	
Operation	EN 60721-3-3:1995 + A2:1997	3K3 (-10 ... +40 °C)	Operation with brake
		3K3 (-15 ... +40 °C)	Operation, without brake
Site altitude			
0 ... 1000 m amsl	-	Without current derating	
1000 ... 4000 m amsl	-	Reduce power by 5 %/1000 m	
Air humidity			
-	-	Average relative humidity 85 %	Without condensation
Vibration resistance			
Operation	EN 60721-3-3:1995 + A2:1997	3M6	
Vibration severity			
-	EN IEC 60034-14	A	
Vibration velocity			
Free suspension	-	1.6 mm/s	
Smooth running, axial runout, concentricity			
-	EN 50347 / IEC 60072-1	Normal class	

DRAFT

Technical data

Rated data

Inverter power supply 400 V, forced ventilated motors

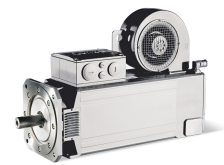

Rated data

Inverter power supply 400 V, forced ventilated motors

Motor			MQA20L29H	MQA20L14H	MQA22P29H	MQA22P17H	MQA22P14H	MQA22P08H
Protection class			IP23	IP23	IP23	IP23	IP23	IP23
Standstill torque	M_0	Nm	76.0	76.0	156	156	156	156
Rated torque	M_{rated}	Nm	66.2	71.3	125	130	135	145
Max. torque	M_{max}	Nm	250	250	500	500	500	500
Rated speed	n_{rated}	rpm	2930	1420	2935	1670	1425	760
Max. speed	n_{max}	rpm	6500	6500	6500	6500	6500	6500
Rated power	P_{rated}	kW	20.3	10.6	38.4	22.7	20.1	11.5
Standstill current	I_0	A	54.0	27.0	102	59.0	51.0	29.5
Rated current	I_{rated}	A	46.9	26.5	86.0	50.3	45.6	27.6
Max. current	I_{max}	A	188	106	344	201	182	110
Rated voltage	V_{rated}	V	360	360	360	360	360	360
Rated frequency	f_{rated}	Hz	100	50	100	58	50	28
Moment of inertia	J	kgcm ²	171	171	487	487	487	487
Efficiency	η		0.900	0.800	0.900	0.880	0.860	0.770
Stator terminal resistance	$R_{UV 20}$ °C	Ω	0.183	0.731	0.089	0.268	0.357	1.072
Stator terminal resistance	$R_{UV 150}$ °C	Ω	0.276	1.102	0.134	0.404	0.538	1.616
Mutual inductance	L_H	mH	13.68	57	23.2	23.86	93.3	92.8
Stator leakage inductance	$L_{1\sigma}$	mH	0.493	1.979	0.892	0.895	3.568	3.53
Rotor leakage inductance	$L_{2\sigma}$	mH	0.524	2.103	1.203	1.206	4.813	4.762
Stator resistance	$R_{1, 20}$	Ω	0.0915	0.365	0.134	0.134	0.536	0.536
Rotor resistance	$R_{2, 20}$	Ω	0.09	0.361	0.12	0.12	0.477	0.477
Weight	m	kg	63.0	63.0	102	102	102	102



Technical data

Rated data
Inverter power supply 400 V, forced ventilated motors

Motor			MQA26T22H	MQA26T12H	MQA26T10H	MQA26T05H
Protection class			IP23	IP23	IP23	IP23
Standstill torque	M_0	Nm	325	325	325	325
Rated torque	M_{rated}	Nm	257	282	288	296
Max. torque	M_{max}	Nm	1100	1100	1100	1100
Rated speed	n_{rated}	rpm	2235	1200	1030	550
Max. speed	n_{max}	rpm	5500	5500	5500	5500
Rated power	P_{rated}	kW	60.2	35.4	31.1	17
Standstill current	I_0	A	171	109	85.5	48.5
Rated current	I_{rated}	A	138	88.8	76.2	44.5
Max. current	I_{max}	A	552	355	305	178
Rated voltage	V_{rated}	V	340	360	360	360
Rated frequency	f_{rated}	Hz	76	42	36	20
Moment of inertia	J	kgcm ²	1340	1340	1340	1340
Efficiency	η		0.920	0.820	0.870	0.810
Stator terminal resistance	$R_{UV,20}$ °C	Ω	0.05	0.15	0.196	0.589
Stator terminal resistance	$R_{UV,150}$ °C	Ω	0.075	0.226	0.295	0.888
Mutual inductance	L_H	mH	18.38	16.8	69.23	69.96
Stator leakage inductance	$L_{1\sigma}$	mH	0.78	0.65	2.91	2.873
Rotor leakage inductance	$L_{2\sigma}$	mH	1.3	0.69	5.09	5.049
Stator resistance	$R_{1,20}$	Ω	0.075	0.075	0.294	0.294
Rotor resistance	$R_{2',20}$	Ω	0.0621	0.1	0.25	0.25
Weight	m	kg	193	193	193	193



Environmental notes and recycling

Lenze has been certified to the worldwide environmental management standard for many years (DIN EN ISO 14001). As part of our environmental policy and the associated climate responsibility, please note the following information on hazardous ingredients and the recycling of Lenze products and their packaging:



Lenze products are partly subject to the EU Directive on the restriction of certain hazardous substances in electrical and electronic equipment 2011/65/EU: RoHS Directive [UKCA: S.I. 2012/3032 - The Restriction of the Use of Certain Hazardous Substances in Electrical and Electronic Equipment Regulations 2012] . This is documented accordingly in the EU declaration of conformity and with the CE mark.



Lenze products are not subject to EU Directive 2012/19/EU: Directive on waste electrical and electronic equipment (WEEE) [UKCA: S.I. 2013/3113 - The Waste Electrical and Electronic Equipment Regulations 2013] , but some contain batteries/rechargeable batteries in accordance with EU Directive 2006/66/EC: Battery Directive [UKCA: S.I. 2009/890 - The Waste Batteries and Accumulators Regulations 2009] . The disposal route, which is separate from household waste, is indicated by corresponding labels with the "crossed-out trash can".

Any batteries/rechargeable batteries included are designed to last the life of the product and do not need to be replaced or otherwise removed by the end user.



Lenze products are usually sold with cardboard or plastic packaging. This packaging complies with EU Directive 94/62/EC: Directive on packaging and packaging waste [UKCA: S.I. 1997/648 - The Producer Responsibility Obligations (Packaging Waste) Regulations 1997] . The required disposal route is indicated by material-specific labels with the "recycling triangle".
Example: "21 - other cardboard"

REACH

Lenze products are subject to REGULATION (EC) No 1907/2006: REACH Regulation [UKCA: S.I. 2008/2852 - The REACH Enforcement Regulations 2008] . When used as intended, exposure of substances to humans, animals and the environment is excluded.

Lenze products are industrial electrical and electronic products and are disposed of professionally. Both the mechanical and electrical components such as electric motors, gearboxes or inverters contain valuable raw materials that can be recycled and reused. Proper recycling and thus maintaining the highest possible level of recyclability is therefore important and sensible from an economic and ecological point of view.

- Coordinate professional disposal with your waste disposal company.
- Separate mechanical and electrical components, packaging, hazardous waste (e.g. gear oils) and batteries/rechargeable batteries wherever possible.
- Dispose of the separated waste in an environmentally sound and proper manner (no household waste or municipal bulky waste).

What?	Material	Disposal instructions
Pallets	Wood	Return to manufacturers, freight forwarders or reusable materials collection system
Packaging material	Paper, cardboard, pasteboard, plastics	Collect and dispose of separately
Products		
Electronic devices	Metal, plastics, circuit boards, heatsinks	As electronic waste give to professional disposer for recycling
Gearbox	Oil	Drain oil and dispose of separately
	Casting, steel, aluminium	Dispose as metal scrap
Motors	Casting, copper, rotors, magnets, potting compound	As engine scrap give to professional disposer for recycling
Dry-cell batteries/rechargeable batteries		As used batteries give to professional disposer for recycling



Further information on Lenze's environmental and climate responsibility and on the topic of energy efficiency can be found on the Internet:

www.Lenze.com → search word: "Sustainability"

Lenze SE
Postfach 101352 · 31763 Hameln
Hans-Lenze-Straße 1 · 31855 Aerzen
GERMANY
Hannover HRB 204803
Phone +49 5154 82-0
Fax +49 5154 82-2800
sales.de@lenze.com
www.Lenze.com

DRAFT