

EDKE70AME064
13438582



Montageanleitung

Mounting Instructions

Instructions de montage

Instrucciones para el montaje

Istruzioni per il montaggio

i700

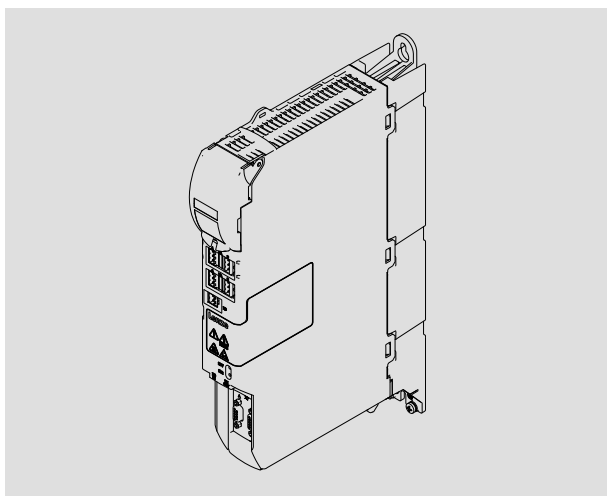

E70ACMSxxxx4xxxxxx

i700 Single- / Double-Inverter

Lenze



Warnings!

Operation of this equipment requires detailed installation and operation instructions provided in the Hardware manual intended for use with this product. This information is provided on the CD-ROM included in the container this device was packaged in. It should be retained with this device at all times. A hard copy of this information may be ordered by phone or e-mail, printed on the back of this document.



Avertissements !

Pour assurer le bon fonctionnement de cet équipement, se conformer aux instructions d'installation et de mise en service contenues dans le manuel correspondant et régissant l'utilisation de ce produit. Ces informations sont contenues sur le CD-ROM compris dans l'emballage livré, qui doit être consultable à tout moment. Une version papier de ces informations peut être commandée par téléphone ou par mail (coordonnées figurant au dos du présent document).



Gefahr!

Gefährliche elektrische Spannung

- ▶ Die Leistungsanschlüsse X101, X102, 107 und X108 führen nach Netz-Ausschalten für die auf dem Gerät angegebene Zeit gefährliche elektrische Spannung.

Mögliche Folgen:

- ▶ Tod oder schwere Verletzungen beim Berühren der Leistungsanschlüsse.

Schutzmaßnahmen:

- ▶ Vor Arbeiten am Gerät Netzspannung ausschalten und mindestens die auf dem Gerät angegebene Zeit abwarten.
- ▶ Prüfen, ob alle Leistungsanschlüsse spannungsfrei sind.

Beachten Sie auch weitere wichtige Informationen zur Geräte- und Sicherheitstechnik auf der beiliegenden CD-ROM!



Danger!

Dangerous voltage

- ▶ The power terminals X101, X102, X107 and X108 carry dangerous voltages for the time given on the device after mains disconnection.

Possible consequences:

- ▶ Death or severe injury if the power terminals are touched.

Protective measures:

- ▶ Switch off the mains voltage and wait at least for the time given on the device before starting to work on the device.
- ▶ Check that all power terminals are deenergised.

Please also observe more important information on device and safety technology provided on the enclosed CD-ROM!



Danger !

Tension électrique dangereuse

- ▶ Les raccordements de puissance X101, X102, X107 et X108 sont susceptibles de véhiculer une tension dangereuse pendant la durée indiquée sur l'appareil après une coupure réseau.

Risques encourus :

- ▶ Mort ou blessures graves en cas de contact avec les raccordements de puissance

Mesures de protection :

- ▶ Avant toute manipulation de l'appareil, couper la tension réseau et attendre la durée indiquée sur l'appareil au minimum.
- ▶ S'assurer que tous les raccordements de puissance sont hors tension.

Veillez également tenir compte des consignes importantes sur la technologie des appareils et les fonctions de sécurité comprises sur le cédérom joint !



¡Peligro!

Voltaje eléctrico peligroso

- ▶ Las conexiones de potencia X101, X102, X107 y X108 siguen vivas después de la desconexión de red durante el tiempo indicado en el equipo.

Posibles consecuencias:

- ▶ Muerte o serias lesiones al tocar las conexiones de potencia.

Medidas de protección:

- ▶ Antes de trabajar en el equipo, desconectar la alimentación de red y esperar por lo menos el tiempo indicado en el equipo.
- ▶ Comprobar, si todas las conexiones de potencia están libres de voltaje.

Observe también la información importante sobre aspectos relativos a la técnica del dispositivo y de seguridad incluida en el CD-ROM adjunto!



Pericolo!

Tensione elettrica pericolosa

- ▶ I collegamenti di potenza X101, X102, X107 e X108 presentano una tensione elettrica pericolosa per il tempo indicato sul dispositivo dopo la disinserzione della rete.

Possibili conseguenze:

- ▶ Morte o gravi lesioni in caso di contatto con i collegamenti di potenza.

Misure di protezione:

- ▶ Attendere almeno per il tempo indicato sul dispositivo prima di eseguire qualsiasi intervento sui collegamenti di potenza.
- ▶ Controllare tutti i collegamenti di potenza per accertare l'assenza di tensione.

Osservare anche le ulteriori informazioni importanti relative a installazione e sicurezza incluse nel CD-ROM allegato!

E70ACMSxxxx45x1xxx

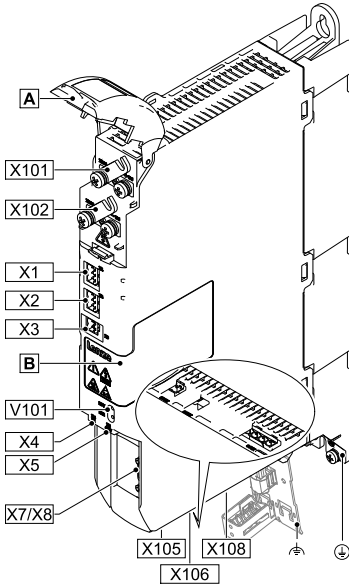

i700M002

E70ACMSxxxx45x2xxx

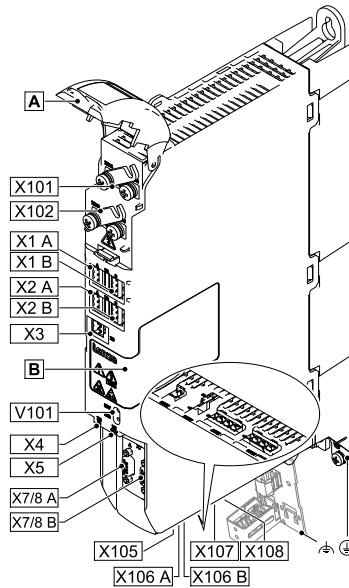

i700M003

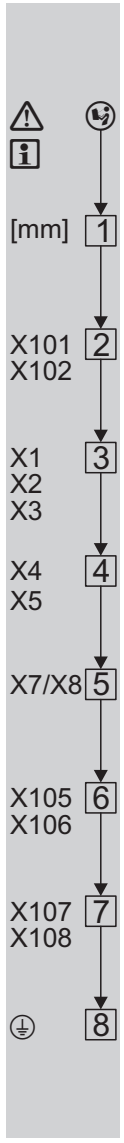
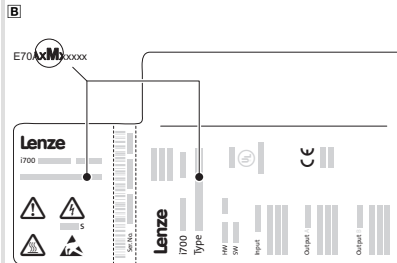
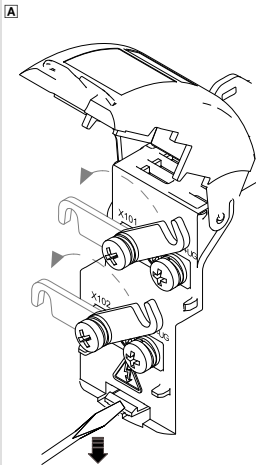

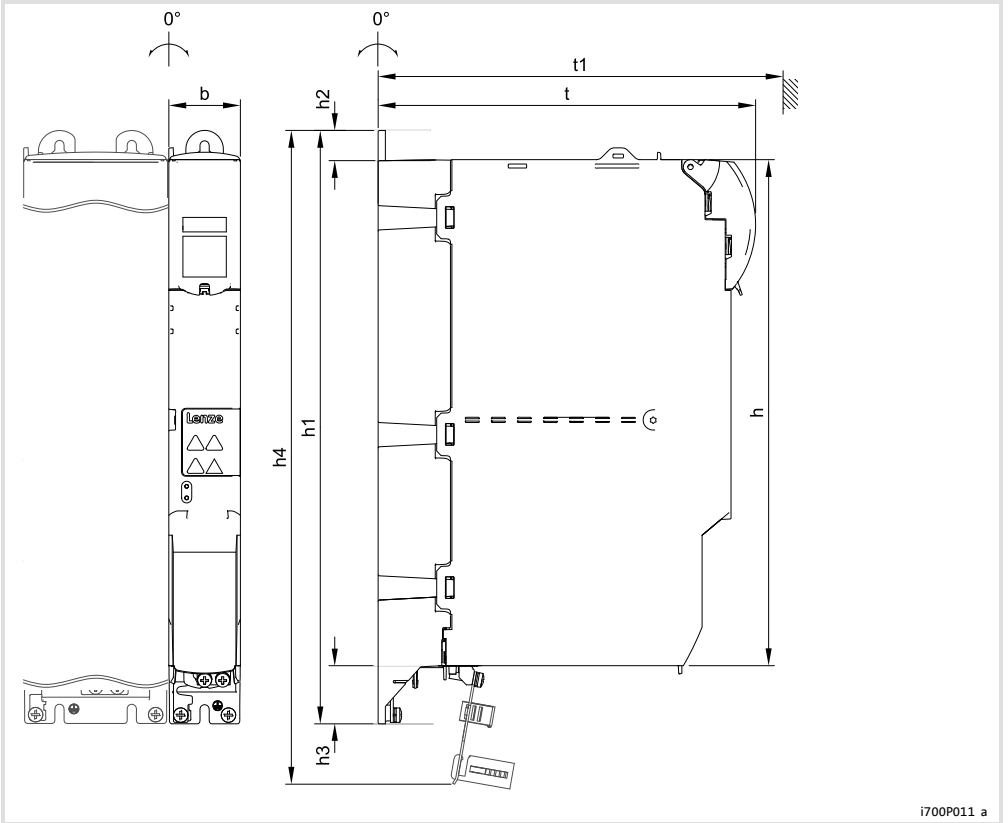

i700P011 a

		h	b	t	h1	h2	h3	h4	t1	t2	
	[A]	[mm]									[kg]
E70ACMSE0054xx1xxx	5										2.7
E70ACMSE0104xx1xxx	10										2.7
E70ACMSE0204xx1xxx	20	350	50	261							2.7
E70ACMSE0054xx2xxx	2 * 5										2.9
E70ACMSE0104xx2xxx	2 * 10										2.9
E70ACMSE0324xx1xxx	32				410	20	40	452	275	-	5.2
E70ACMSE0484xx1xxx	48										5.2
E70ACMSE0644xx1xxx	64	350	100	261							5.2
E70ACMSE0204xx2xxx	2 * 20										5.2
E70ACMSE0324xx2xxx	2 * 32										5.2

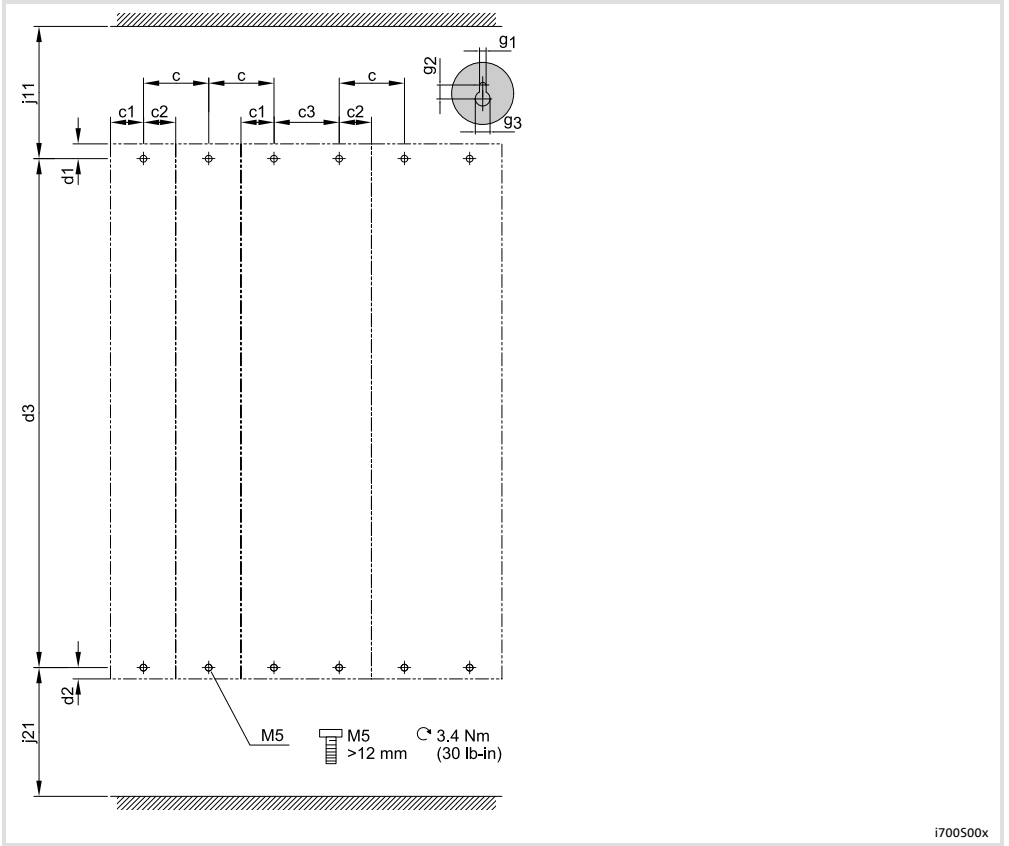

i700500x

		c	c1	c2	c3	d1	d2	d3	j11	j21	g1	g2	g3
	[A]	[mm]											
E70ACMSE0054xx1xxx	5												
E70ACMSE0104xx1xxx	10												
E70ACMSE0204xx1xxx	20				-								
E70ACMSE0054xx2xxx	2*5												
E70ACMSE0104xx2xxx	2*10	50	25	25		10	10	390	90	70	6	10	15
E70ACMSE0324xx1xxx	32												
E70ACMSE0484xx1xxx	48												
E70ACMSE0644xx1xxx	64				50								
E70ACMSE0204xx2xxx	2*20												
E70ACMSE0324xx2xxx	2*32												

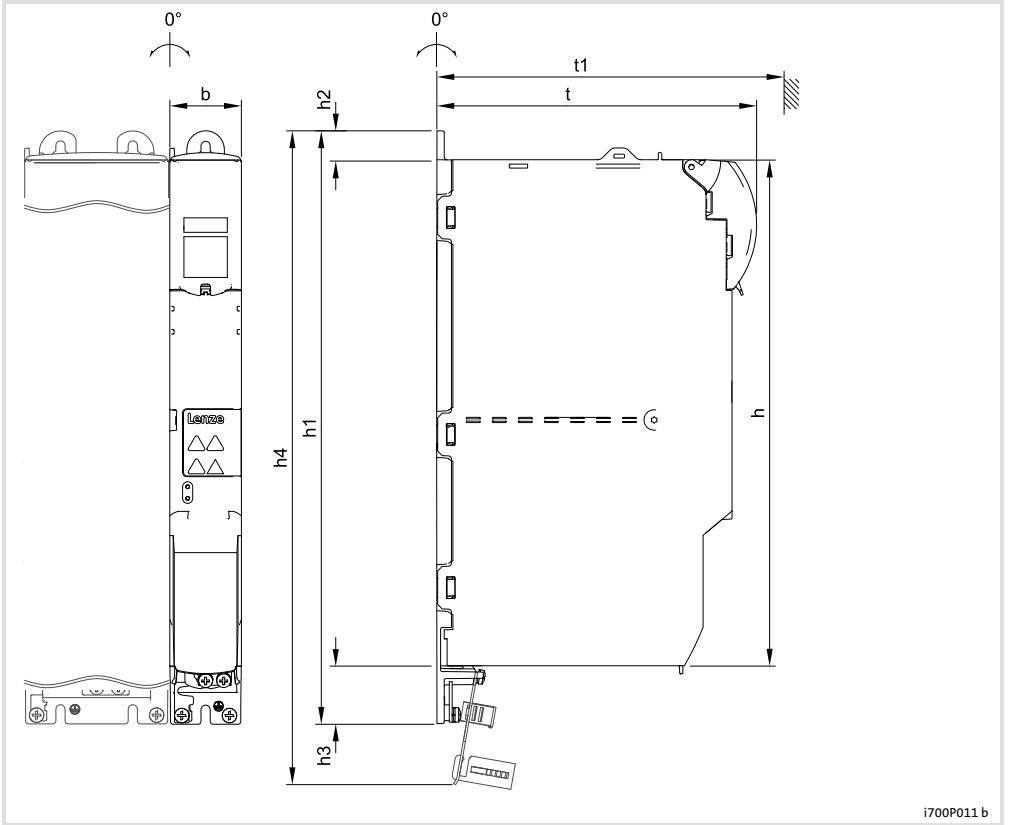

i700P011 b

		h	b	t	h1	h2	h3	h4	t1	t2	
	[A]	[mm]									[kg]
E70ACMSC0054xx1xxx	5	350	50	221	410	20	40	452	235	-	2.3
E70ACMSC0104xx1xxx	10										2.3
E70ACMSC0204xx1xxx	20										2.3
E70ACMSC0054xx2xxx	2 * 5										2.5
E70ACMSC0104xx2xxx	2 * 10										2.5
E70ACMSC0324xx1xxx	32	350	100	221	410	20	40	452	235	-	5.3
E70ACMSC0484xx1xxx	48										5.3
E70ACMSC0644xx1xxx	64										5.3
E70ACMSC0204xx2xxx	2 * 20										5.3
E70ACMSC0324xx2xxx	2 * 32										5.3

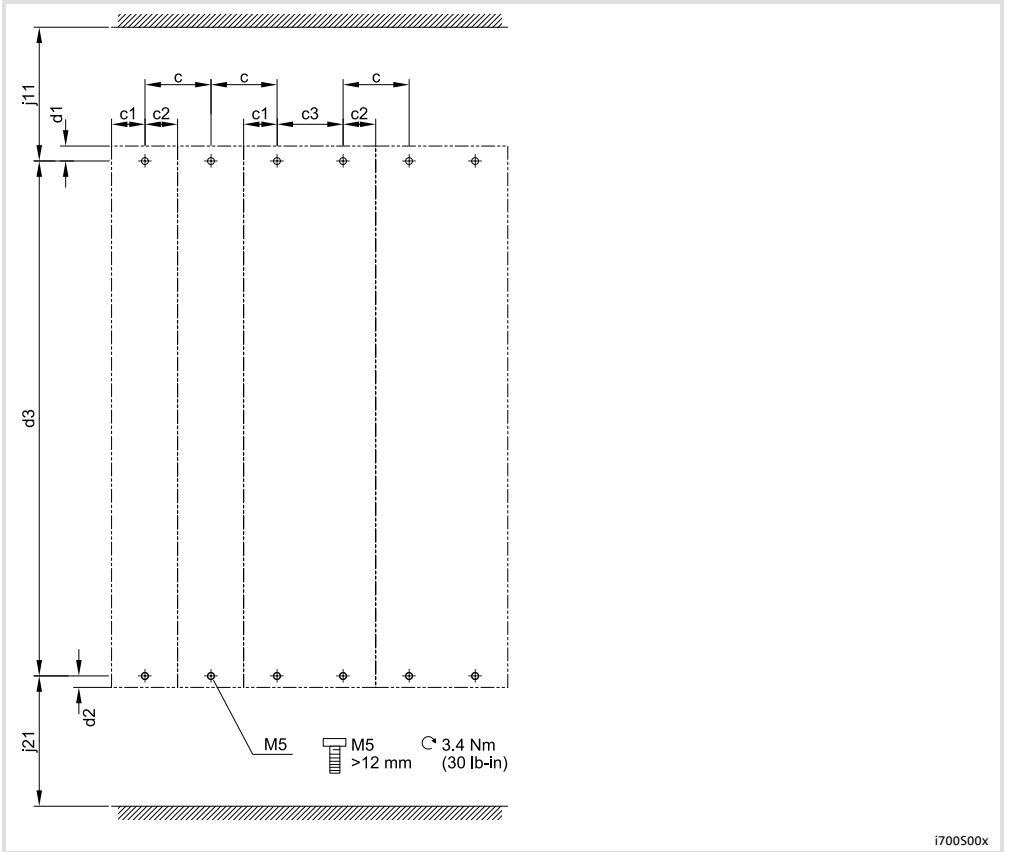

i700500x

		c	c1	c2	c3	d1	d2	d3	j11	j21
	[A]	[mm]								
E70ACMSC0054xx1xxx	5									
E70ACMSC0104xx1xxx	10									
E70ACMSC0204xx1xxx	20				-					
E70ACMSC0054xx2xxx	2*5									
E70ACMSC0104xx2xxx	2*10	50	25	25	50	10	10	390	90	70
E70ACMSC0324xx1xxx	32									
E70ACMSC0484xx1xxx	48									
E70ACMSC0644xx1xxx	64									
E70ACMSC0204xx2xxx	2*20									
E70ACMSC0324xx2xxx	2*32									

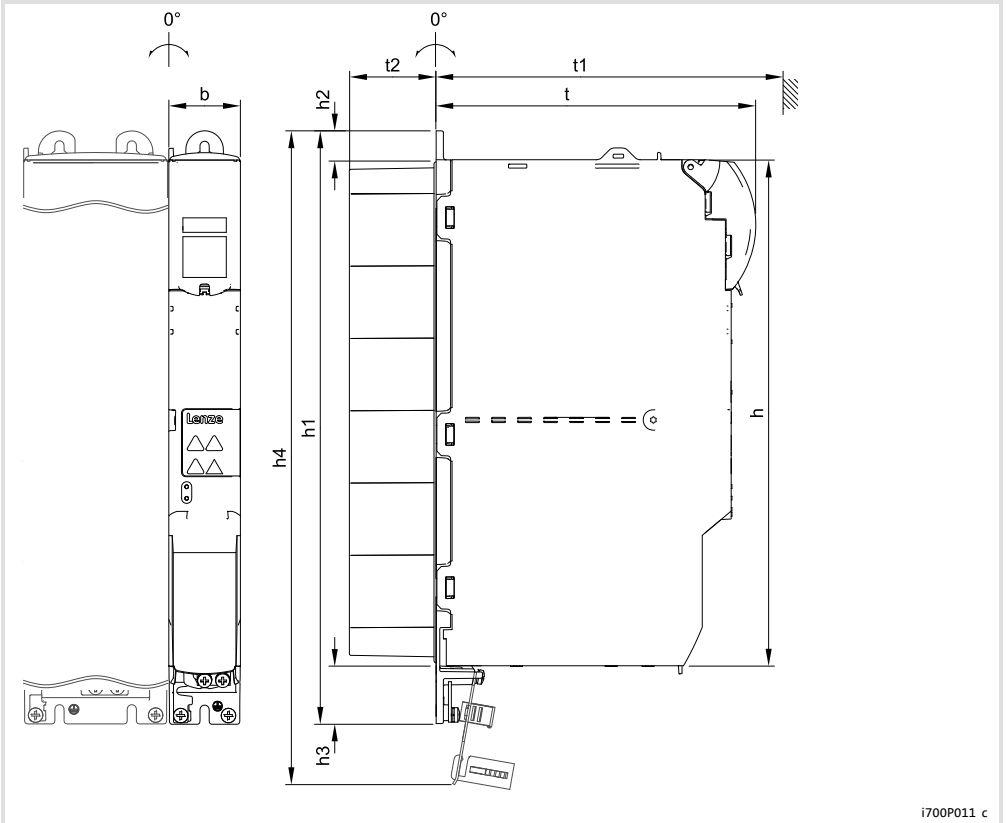

i700P011 c

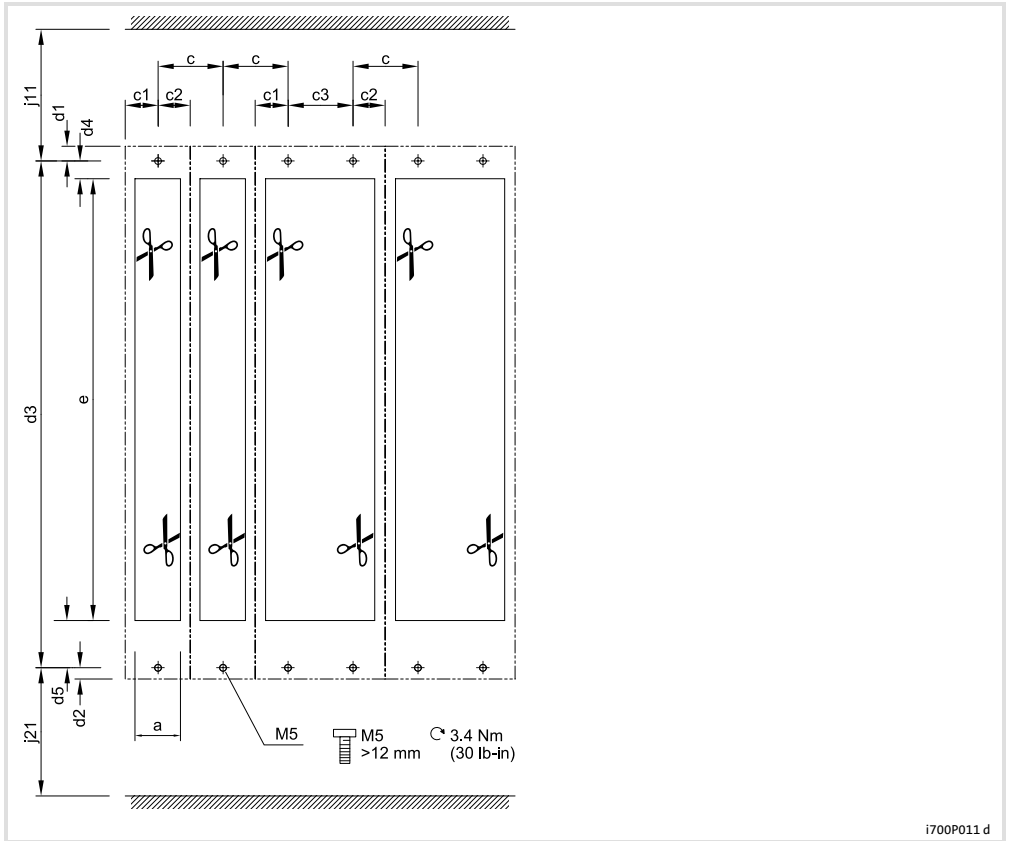

		h	b	t	h1	h2	h3	h4	t1	t2	
	[A]	[mm]									[kg]
E70ACMSD0054xx1xxx	5										3.0
E70ACMSD0104xx1xxx	10										3.0
E70ACMSD0204xx1xxx	20	350	50	221							3.0
E70ACMSD0054xx2xxx	2 * 5										3.2
E70ACMSD0104xx2xxx	2 * 10				410	20	40	452	235	60	3.2
E70ACMSD0324xx1xxx	32										7.1
E70ACMSD0484xx1xxx	48										7.1
E70ACMSD0644xx1xxx	64	350	100	221							7.1
E70ACMSD0204xx2xxx	2 * 20										7.1
E70ACMSD0324xx2xxx	2 * 32										7.1

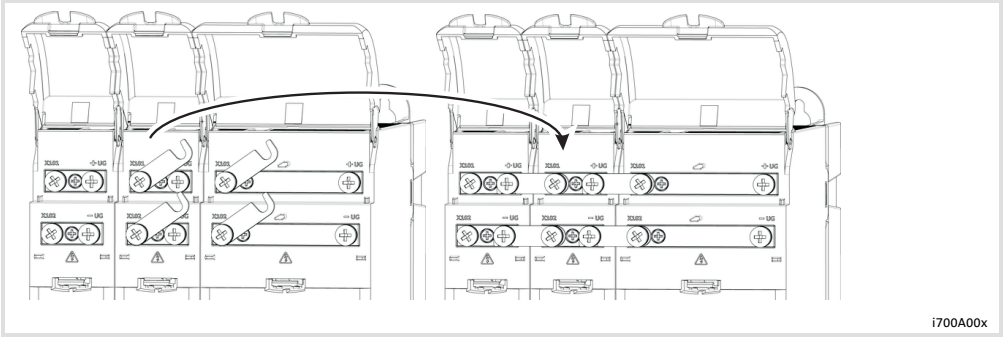

	a	e	c	c1	c2	c3	d1	d2	d3	d4	d5	j11	j21
	[mm]												
E70ACMSD0054xx1xxx	5												
E70ACMSD0104xx1xxx	10												
E70ACMSD0204xx1xxx	20												
E70ACMSD0054xx2xxx	2*5												
E70ACMSD0104xx2xxx	2*10												
E70ACMSD0324xx1xxx	32	340	50	25	25		10	10	390	15	35	90	70
E70ACMSD0484xx1xxx	48												
E70ACMSD0644xx1xxx	64	85				50							
E70ACMSD0204xx2xxx	2*20												
E70ACMSD0324xx2xxx	2*32												

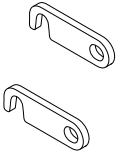

i700A00x

	[Nm]	 [lb-in]	
	5.0	44.3	PH 3

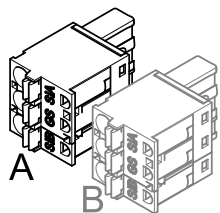

X1

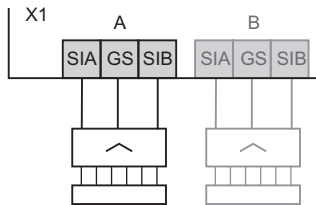

i700AX001





i700M00x

		
	[mm ²] [AWG]	[mm]
	0.2 ... 2.5 24 ... 12	10

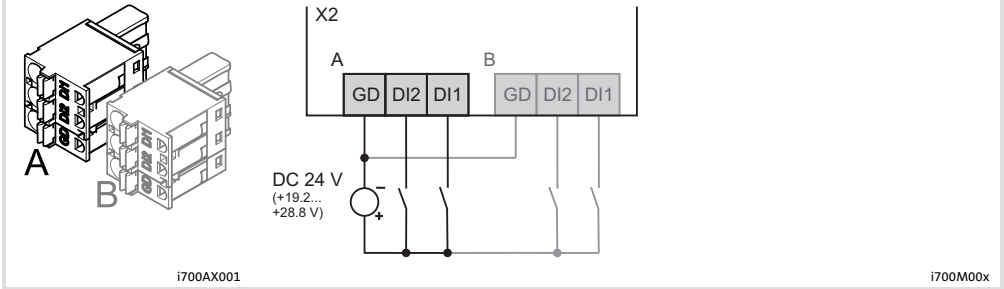

X2

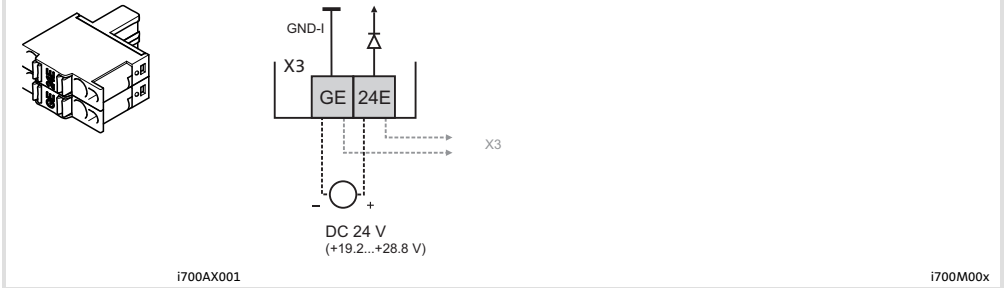

		
	[mm ²] [AWG]	[mm]
	0.2 ... 2.5 24 ... 12	10

X3



		
	[mm ²] [AWG]	[mm]
	0.2 ... 2.5 24 ... 12	10

X4/X5

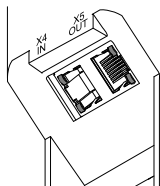

i700AX001

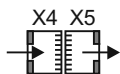

i700M00x

X7 E70ACM...R

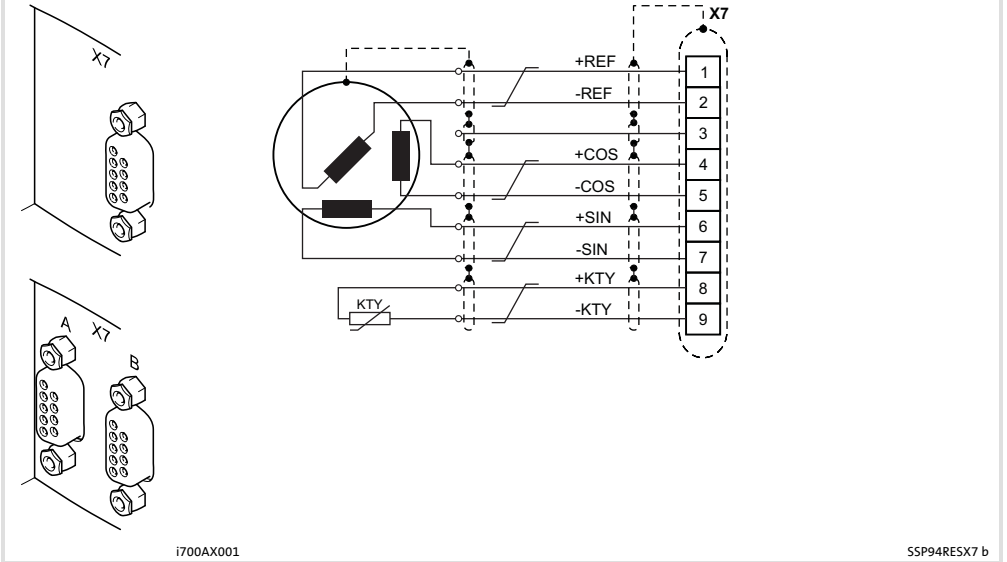

X8 - E70ACM...E

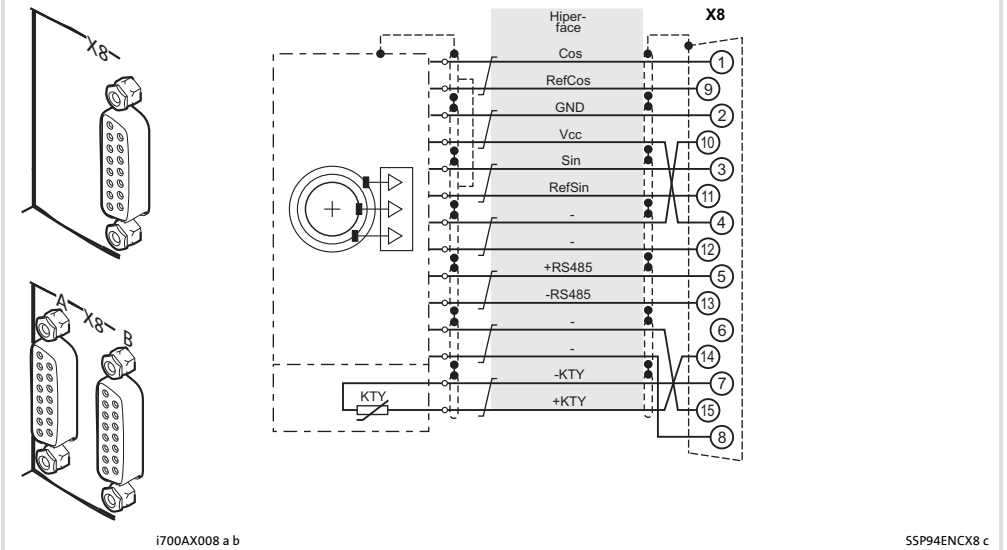

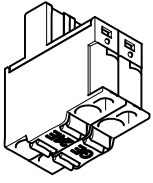

X105

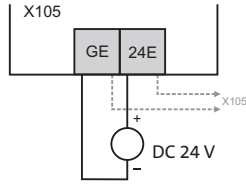

i700AX001

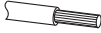

i700M00x

		
	[mm ²] [AWG]	[mm]
	0.2 ... 2.5 24 ... 12	10

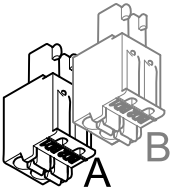

X106

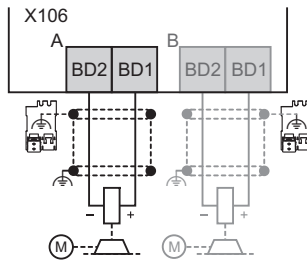

i700AX001



i700M00x



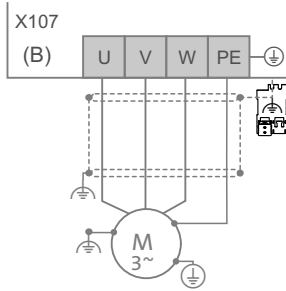
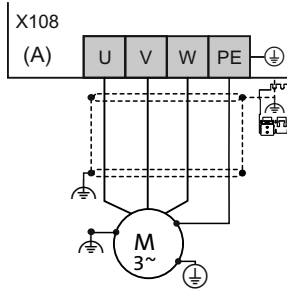
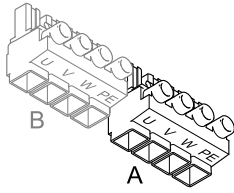

		
	[mm ²] [AWG]	[mm]
	0.2 ... 1.5 24 ... 16	10

X107, X108



i700AX001

i700S010 9



					
	[mm ²]	[AWG]	[Nm]	[lb-in]	
E70ACMSx0054x1xxx E70ACMSx0104x1xxx E70ACMSx0204x1xxx E70ACMSx0054x2xxx E70ACMSx0104x2xxx E70ACMSx0204x2xxx E70ACMSx0324x2xxx	0.2 ... 4	24 ... 12	0.5	4.4	3.5 x 0.6
E70ACMSx0324x1xxx E70ACMSx0484x1xxx E70ACMSx0644x1xxx	0.5 ... 16	22 ... 6	1.5	13.3	5.5 x 1

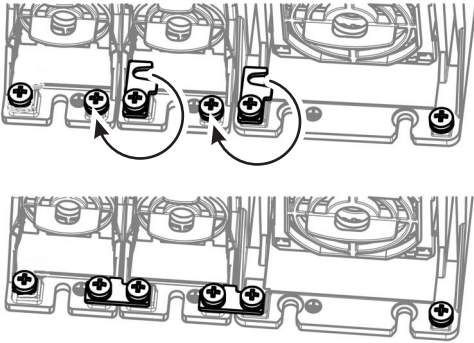

⊕



i700A00x

	[Nm]		[lb-in]	
	2.5		22.1	PH 2

⊖

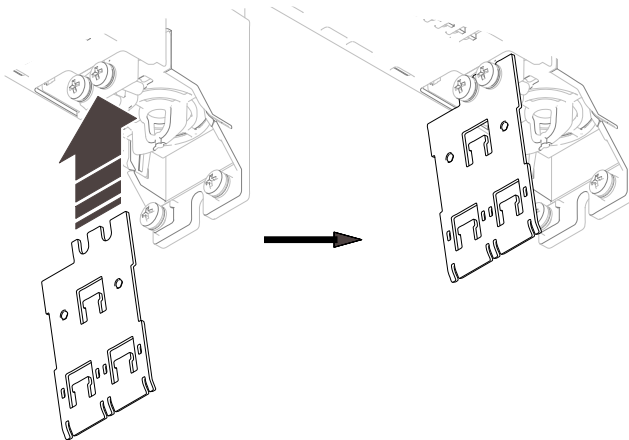

i700M00x



© 06/2014

Lenze Automation GmbH
Postfach 10 13 52, D-31763 Hameln
Hans-Lenze-Str. 1, D-31855 Aerzen
Germany



+49 5154 82-0



+49 5154 82-2800



lenze@lenze.com



www.lenze.com



Service Lenze Service GmbH
Breslauer Straße 3, D-32699 Extertal

Germany



008000 2446877 (24 h helpline)



+49 5154 82-1112



service@lenze.com

EDKE70AME064 ■ 13438582 ■ DE/EN/FR/ES/IT ■ 4.1 ■ TD00

10 9 8 7 6 5 4 3 2 1

EDKE70APE060
13438581



Montageanleitung

Mounting Instructions

Instructions de montage

Instrucciones para el montaje

Istruzioni per il montaggio

i700

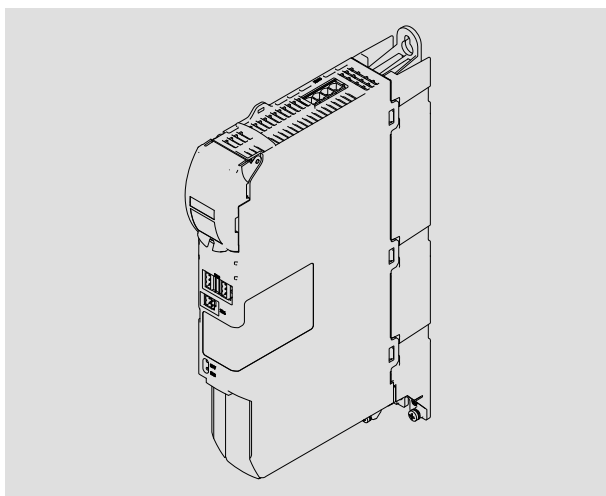

E70ACPSxxx4x

i700 Power Supply

Lenze



Warnings!

Operation of this equipment requires detailed installation and operation instructions provided in the Hardware manual intended for use with this product. This information is provided on the CD-ROM included in the container this device was packaged in. It should be retained with this device at all times. A hard copy of this information may be ordered by phone or e-mail, printed on the back of this document.



Avertissements !

Pour assurer le bon fonctionnement de cet équipement, se conformer aux instructions d'installation et de mise en service contenues dans le manuel correspondant et régissant l'utilisation de ce produit. Ces informations sont contenues sur le CD-ROM compris dans l'emballage livré, qui doit être consultable à tout moment. Une version papier de ces informations peut être commandée par téléphone ou par mail (coordonnées figurant au dos du présent document).



Gefahr!

Gefährliche elektrische Spannung

- ▶ Die Leistungsanschlüsse X100, X101, X102 und X103 führen nach Netz-Ausschalten für die auf dem Gerät angegebene Zeit gefährliche elektrische Spannung.

Mögliche Folgen:

- ▶ Tod oder schwere Verletzungen beim Berühren der Leistungsanschlüsse.

Schutzmaßnahmen:

- ▶ Vor Arbeiten am Gerät Netzspannung ausschalten und mindestens die auf dem Gerät angegebene Zeit abwarten.
- ▶ Prüfen, ob alle Leistungsanschlüsse spannungsfrei sind.

Beachten Sie auch weitere wichtige Informationen zur Geräte- und Sicherheitstechnik auf der beiliegenden CD-ROM!



Danger!

Dangerous voltage

- ▶ The power terminals X100, X101, X102 and X103 carry dangerous voltages for the time given on the device after mains disconnection.

Possible consequences:

- ▶ Death or severe injury if the power terminals are touched.

Protective measures:

- ▶ Switch off the mains voltage and wait at least for the time given on the device before starting to work on the device.
- ▶ Check that all power terminals are deenergised.

Please also observe more important information on device and safety technology provided on the enclosed CD-ROM!



Danger !

Tension électrique dangereuse

- ▶ Les raccordements de puissance X100, X101, X102 et X103 sont susceptibles de véhiculer une tension dangereuse pendant la durée indiquée sur l'appareil après une coupure réseau.

Risques encourus :

- ▶ Mort ou blessures graves en cas de contact avec les raccordements de puissance

Mesures de protection :

- ▶ Avant toute manipulation de l'appareil, couper la tension réseau et attendre la durée indiquée sur l'appareil au minimum.
- ▶ S'assurer que tous les raccordements de puissance sont hors tension.

Veillez également tenir compte des consignes importantes sur la technologie des appareils et les fonctions de sécurité comprises sur le cédérom joint !



¡Peligro!

Voltaje eléctrico peligroso

- ▶ Las conexiones de potencia X100, X101, X102 y X103 siguen vivas después de la desconexión de red durante el tiempo indicado en el equipo.

Posibles consecuencias:

- ▶ Muerte o serias lesiones al tocar las conexiones de potencia.

Medidas de protección:

- ▶ Antes de trabajar en el equipo, desconectar la alimentación de red y esperar por lo menos el tiempo indicado en el equipo.
- ▶ Comprobar, si todas las conexiones de potencia están libres de voltaje.

Observe también la información importante sobre aspectos relativos a la técnica del dispositivo y de seguridad incluida en el CD-ROM adjunto!



Pericolo!

Tensione elettrica pericolosa

- ▶ I collegamenti di potenza X100, X101, X102 e X103 presentano una tensione elettrica pericolosa per il tempo indicato sul dispositivo dopo la disinserzione della rete.

Possibili conseguenze:

- ▶ Morte o gravi lesioni in caso di contatto con i collegamenti di potenza.

Misure di protezione:

- ▶ Attendere almeno per il tempo indicato sul dispositivo prima di eseguire qualsiasi intervento sui collegamenti di potenza.
- ▶ Controllare tutti i collegamenti di potenza per accertare l'assenza di tensione.

Osservare anche le ulteriori informazioni importanti relative a installazione e sicurezza incluse nel CD-ROM allegato!

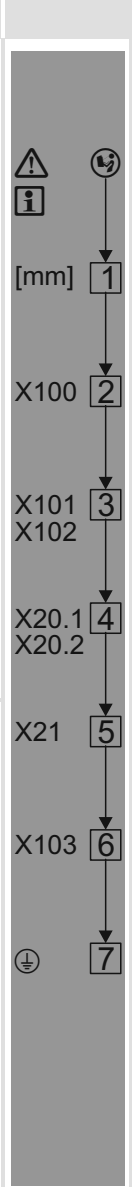
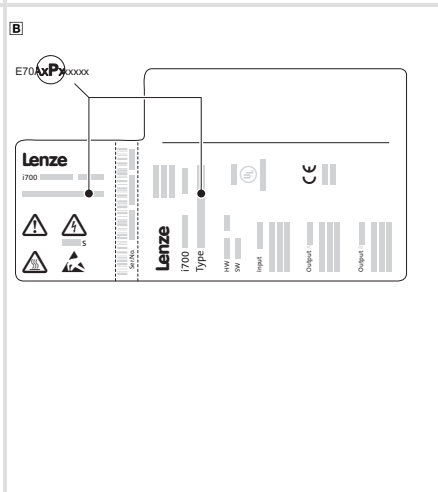
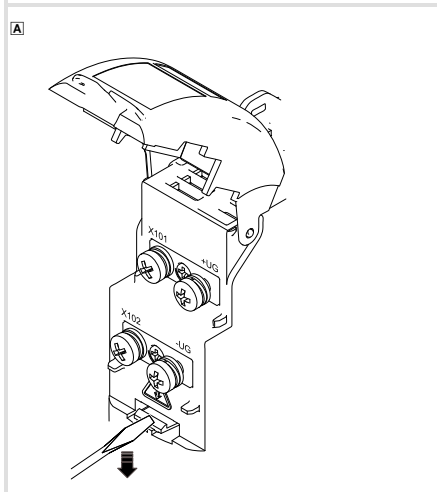
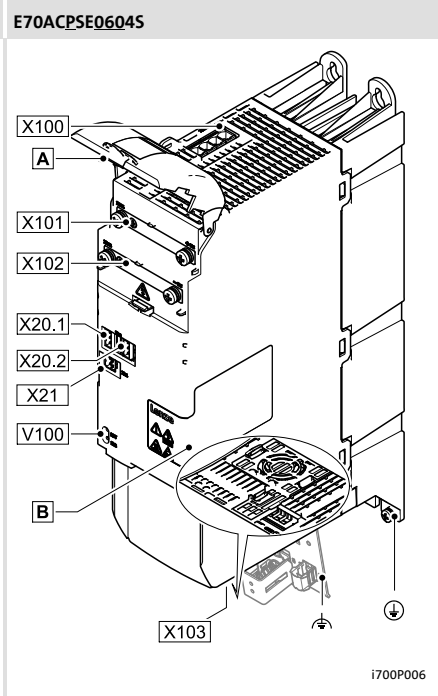
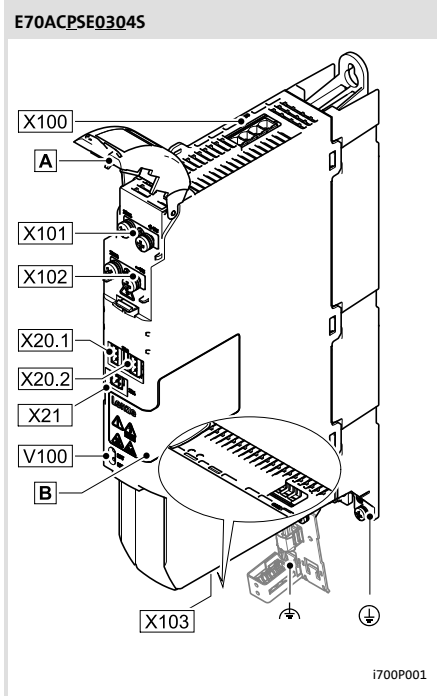

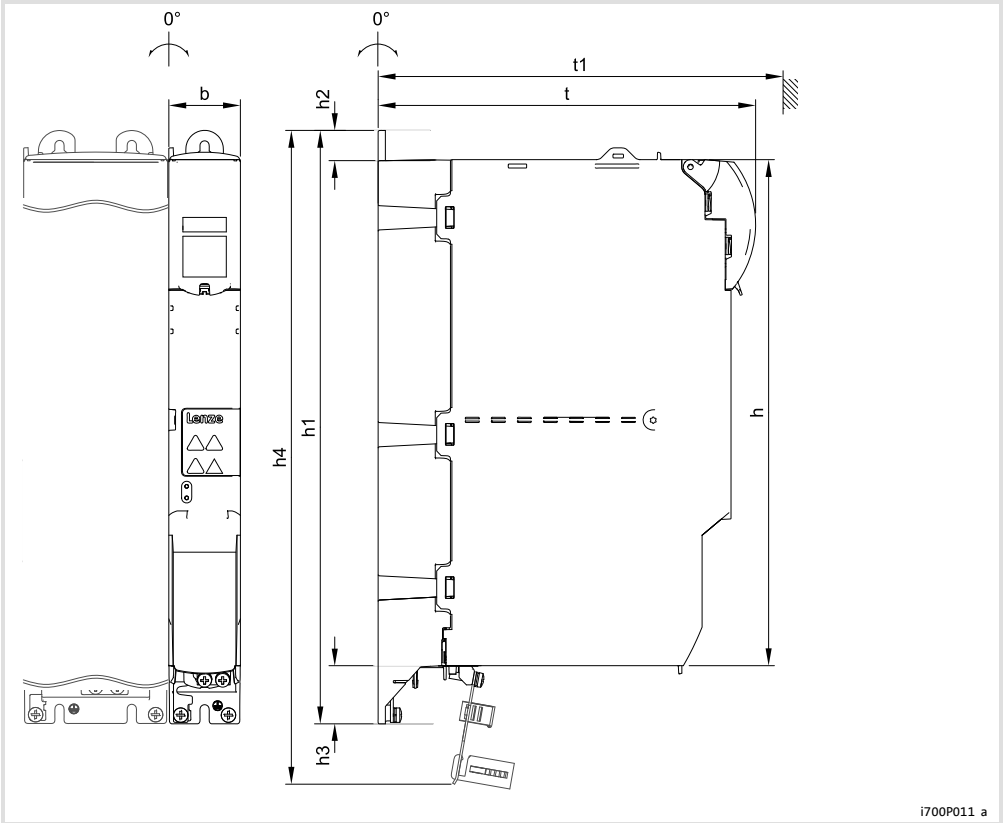

i700P011 a

		h	b	t	h1	h2	h3	h4	t1	t2	
	[A]	[mm]									[kg]
E70ACPSE03Q4x	30	350	50	261	410	20	40	452	275	-	2.5
E70ACPSE06Q4x	60	350	100	261							5.3

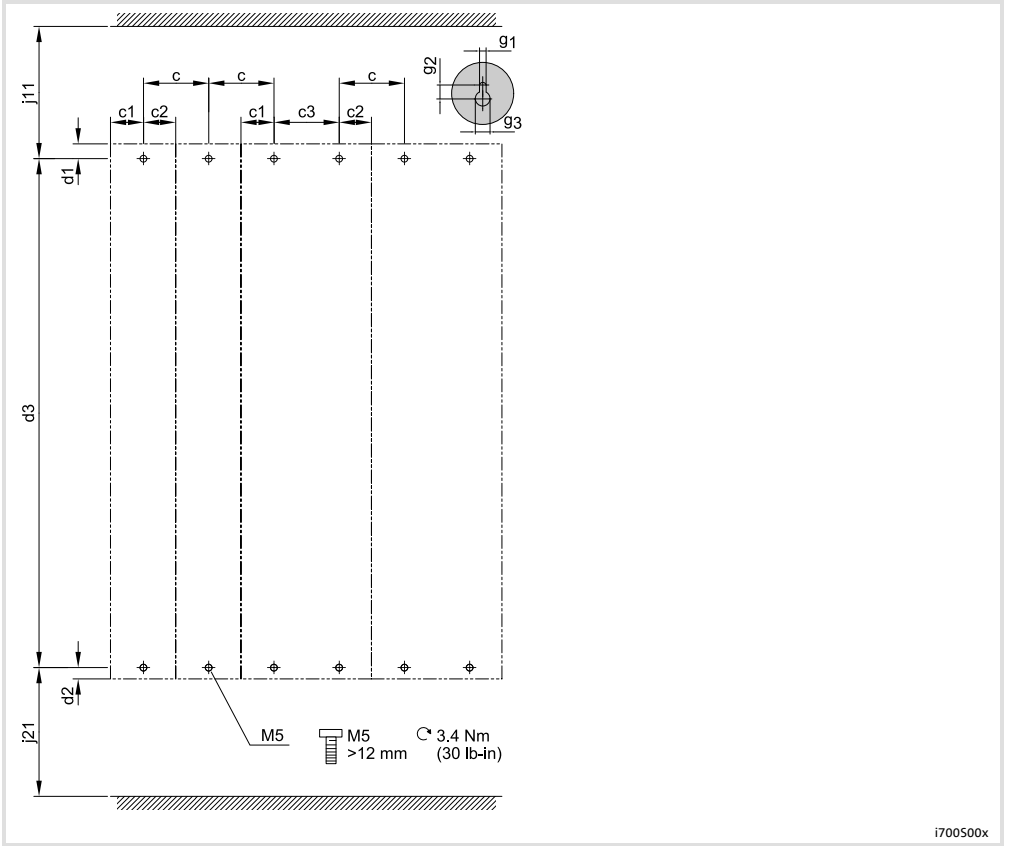

i700500x

		c	c1	c2	c3	d1	d2	d3	j11	j21	g1	g2	g3
	[A]	[mm]											
E70ACPSE0304x	30	50	25	25	-	10	10	390	90	70	6	10	15
E70ACPSE0604x	60				50								

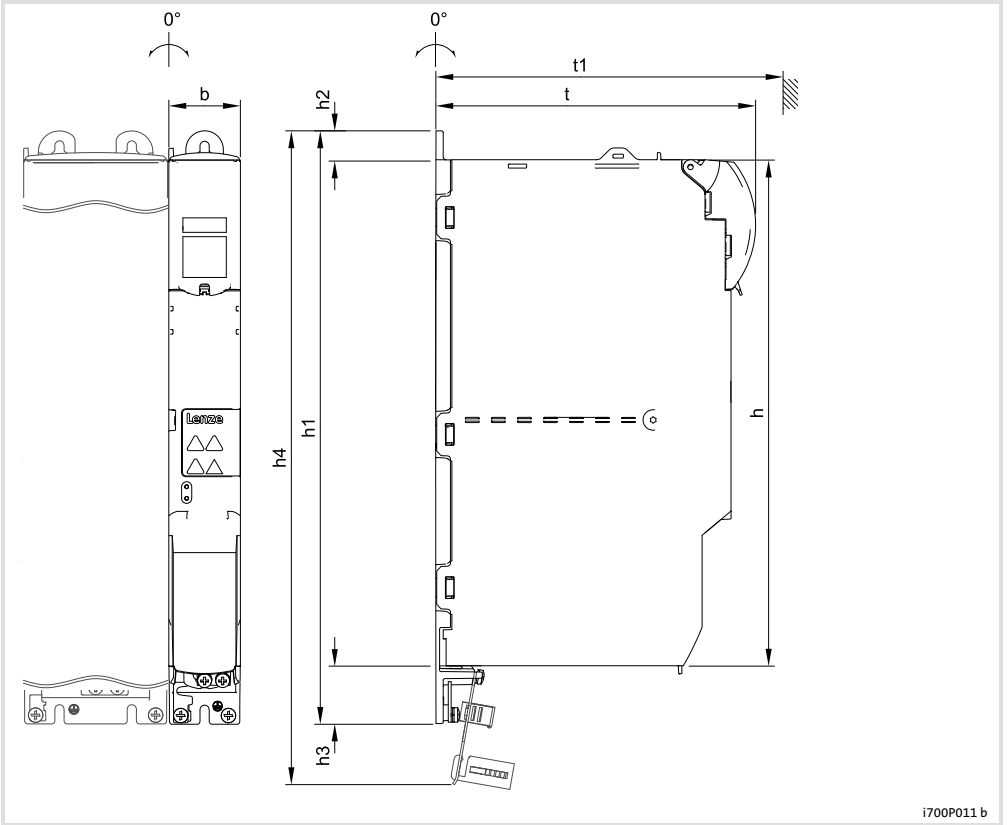

i700P011 b

		h	b	t	h1	h2	h3	h4	t1	t2	
	[A]	[mm]									[kg]
E70ACPSC0304x	30	350	50	221	410	20	40	452	235	-	2.1
E70ACPSC0604x	60	350	100	221							5.4

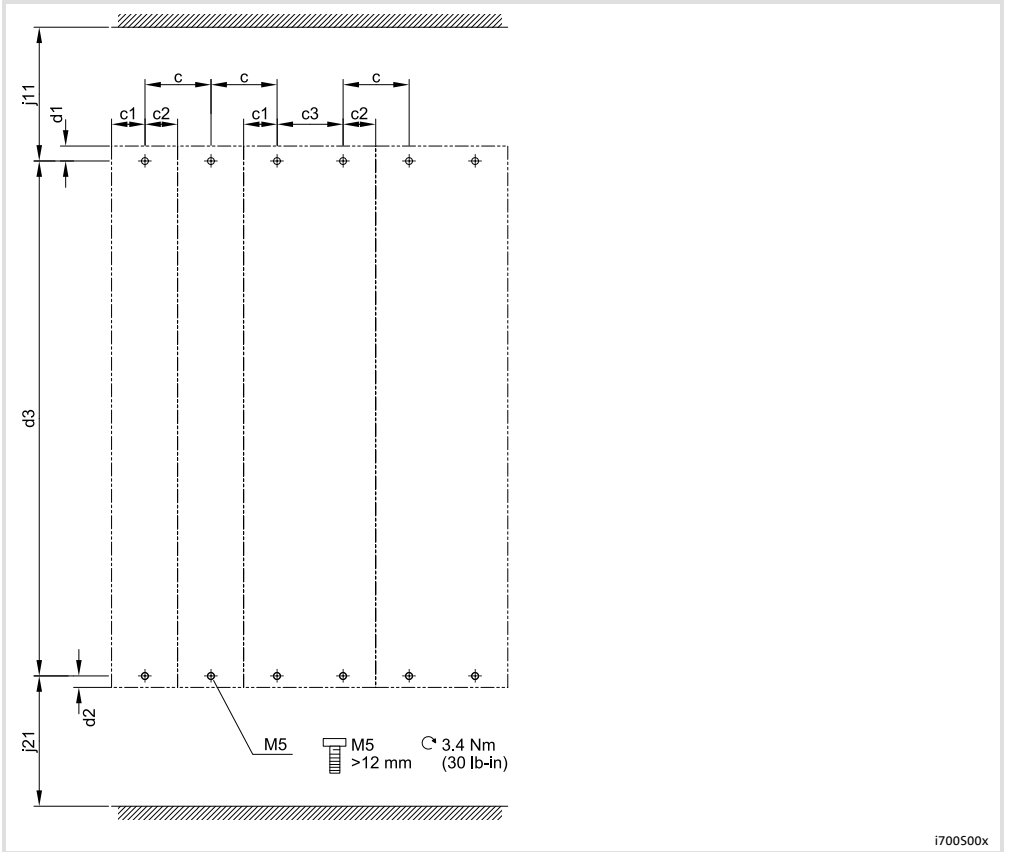

i700500x

		c	c1	c2	c3	d1	d2	d3	j11	j21
[A]		[mm]								
E70ACPSC0304x	30	50	25	25	-	10	10	390	90	70
E70ACPSC0604x	60				50					

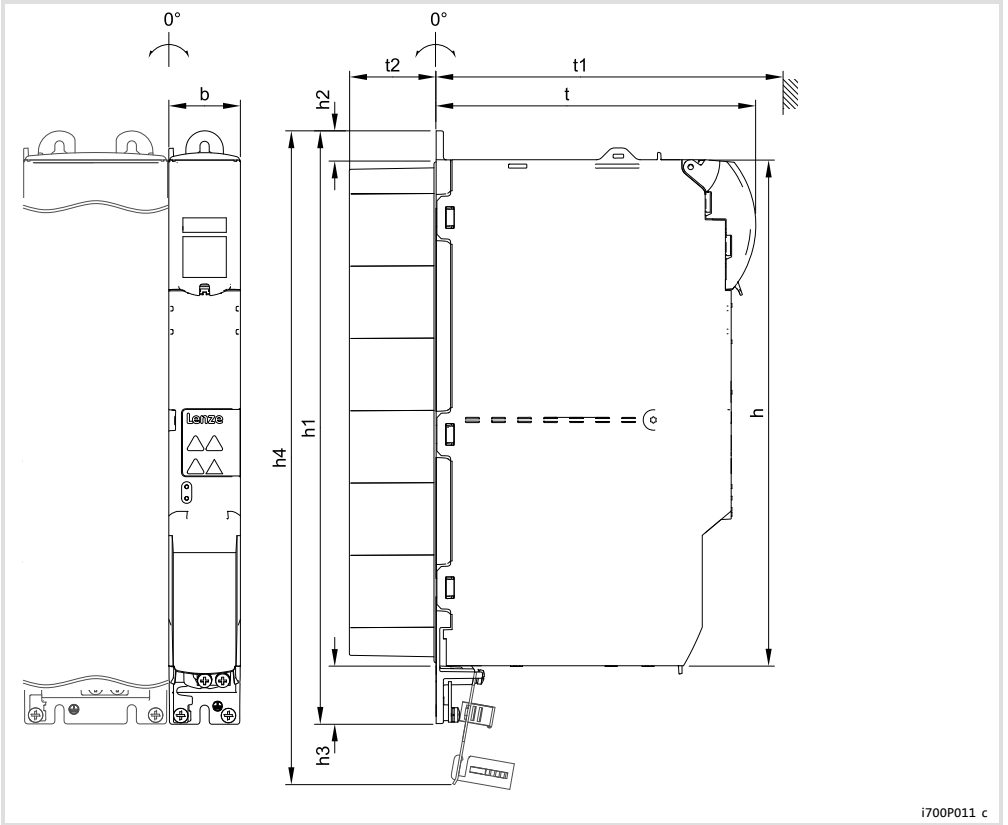

		h	b	t	h1	h2	h3	h4	t1	t2	
	[A]	[mm]									[kg]
E70ACPSD0304x	30	350	50	221	410	20	40	452	235	60	2.8
E70ACPSD0604x	60	350	100	221							7.3

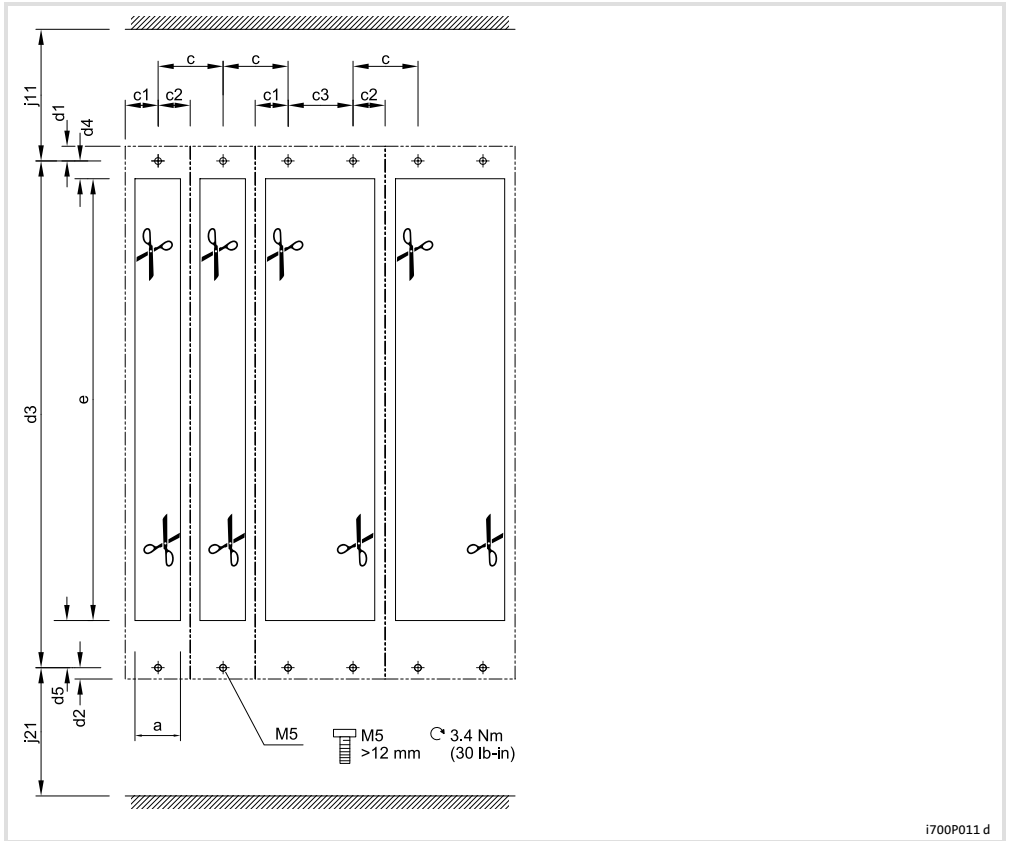

		a	e	c	c1	c2	c3	d1	d2	d3	d4	d5	j11	j21
	[A]	[mm]												
E70ACPSD0304x	30	35	340	50	25	25	-	10	10	390	15	35	90	70
E70ACPSD0604x	60	85					50							



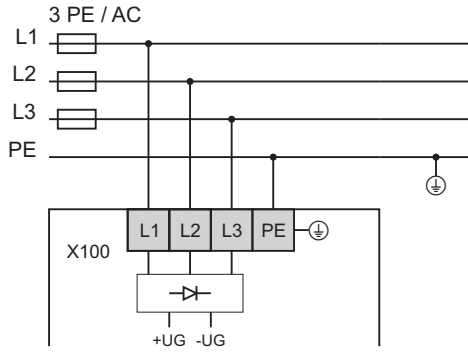
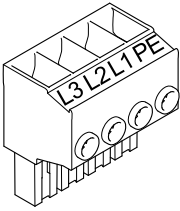

X100 (400 V)

X100





i700PX103

i700S010 7

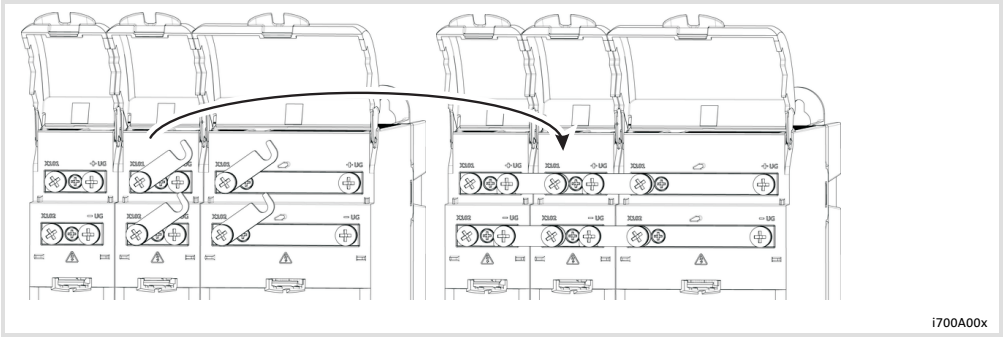
					
	[mm ²]	[AWG]	[lb-in]		
E70ACP5x0304x	0.5 ... 16	22 ... 6	1.2 ... 1.5	10.6 ... 13.3	5.5 x 1
E70ACP5x0604x					



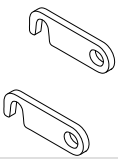

	[Nm]	 [lb-in]	
	5.0	44.3	PH 3

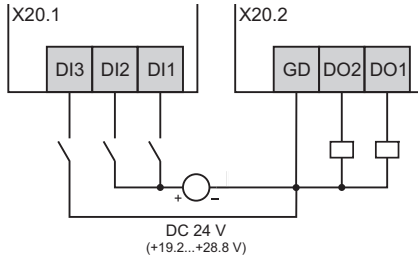
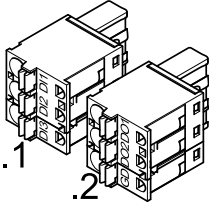
X20



i700PX020

i700S010

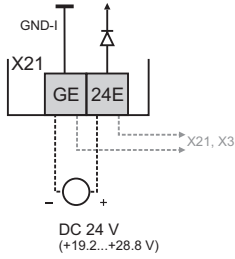
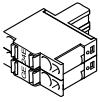

		
	[mm ²] [AWG]	[mm]
	0.2 ... 2.5 24 ... 12	10

X21



i700PX021

i700M00x



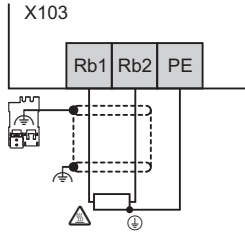
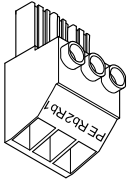

		
	[mm ²] [AWG]	[mm]
	0.2 ... 2.5 24 ... 12	10

X103





i700PX103

i7005010 8

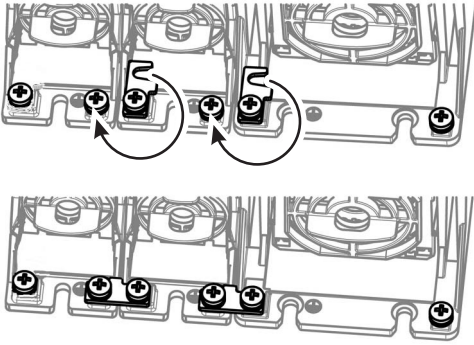
					
	[mm ²]	[AWG]	[Nm]	[lb-in]	
E70ACP5x0304x	0.5 ... 6	22 ... 10	0.5 ... 0.6	4.4 ... 5.3	4.5 x 0.8 PH1
E70ACP5x0604x					



i700A00x

	[Nm]		[lb-in]	
	2.5		22.1	PH 2

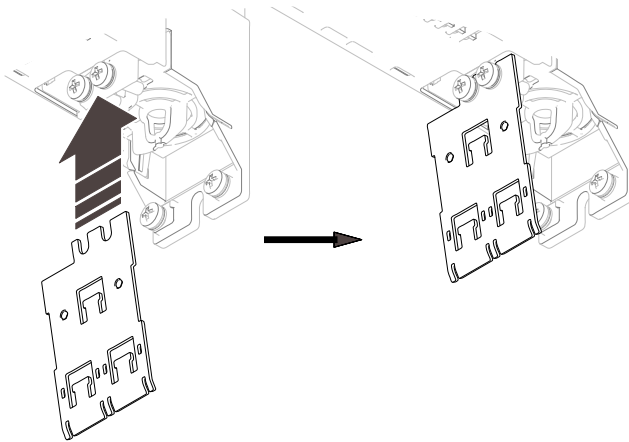

i700M00x



© 06/2014

Lenze Automation GmbH
Postfach 10 13 52, D-31763 Hameln
Hans-Lenze-Str. 1, D-31855 Aerzen
Germany



+49 5154 82-0



+49 5154 82-2800



lenze@lenze.com



www.lenze.com



Service Lenze Service GmbH
Breslauer Straße 3, D-32699 Extertal

Germany



008000 2446877 (24 h helpline)



+49 5154 82-1112



service@lenze.com

EDKE70APE060 ■ 13438581 ■ DE/EN/FR/ES/IT ■ 2.1 ■ TD00

10 9 8 7 6 5 4 3 2 1