

Controllers



c550 controller



Contents

1	About this document	8
1.1	Document description.....	9
1.2	Further documents	10
1.3	Notations and conventions	11
2	Safety instructions	12
2.1	Basic safety instructions.....	12
2.2	Application as directed.....	13
2.3	Residual hazards	14
3	Product information	15
3.1	Identification of the products.....	15
3.2	Features.....	16
3.3	SD card	17
3.4	Application Credit	18
3.5	Backplane bus.....	19
3.6	Engineering tool »PLC Designer«.....	20
3.7	License information	21
4	Mechanical installation	22
4.1	Dimensions.....	22
4.2	Mounting the controller.....	24
4.3	Mounting the I/O system 1000.....	25
5	Electrical installation	26
5.1	Important notes.....	26
5.2	Mains connection	27
5.3	Networks	28
6	Commissioning	29
6.1	Installation of »PLC Designer«.....	30
6.2	Commissioning steps	31
6.3	Connect controller and Engineering PC.....	32
6.4	Set IP address on the PC.....	33
6.5	Start controller.....	34
6.6	Access to SD card.....	35
6.7	Create PLC program	36
6.8	Create task.....	37
6.9	Compile PLC program code	38
6.10	Establish connection between controller and »PLC Designer«.....	39
6.11	Log in to the controller (load configuration).....	40
6.12	Parameterize controller.....	41
6.12.1	General information on parameter setting.....	41
6.12.1.1	Addressing of the parameters.....	41
6.12.1.2	Structure of the parameter descriptions	42
6.12.2	Saving the parameter settings.....	42
6.12.3	Reset parameters to default	43
6.13	Start PLC program.....	44
6.14	Generate boot application	45

Contents

7	Device settings	46
7.1	Device name	46
7.2	Host name	47
7.3	Name server addresses	48
7.4	Time	49
7.4.1	NTP server addresses	50
7.5	Device commands	51
7.5.1	Save parameter settings	52
7.5.2	Reset parameters to default	52
7.5.3	Restart device	53
7.5.4	Start/stop application	53
7.5.5	Load boot project	54
7.5.6	Delete logbook	54
7.5.7	Export logbook	54
7.5.8	Delete log files	55
7.5.9	Reset cold	55
7.5.10	Reset origin	55
7.6	Firmware update mode for field devices	56
8	Configure engineering port	58
8.1	Automatic configuration via parameters	59
8.2	Manual configuration via parameters	60
8.3	Configuration via file	61
8.4	Perform restart with current settings	62
8.5	Diagnostics	63
8.5.1	Active engineering port settings	63

9	Configuring the network	64
9.1	EtherCAT master	65
9.1.1	EtherCAT state machine	66
9.1.2	Addressing of the slaves	68
9.1.3	Commissioning	69
9.1.4	Determine the physical EtherCAT configuration (network scan)	70
9.1.5	Edit EtherCAT I/O mapping	73
9.1.5.1	Set PDO mapping	73
9.1.5.2	Activate PDO mapping	73
9.1.6	Restart network	74
9.1.7	Parameter data transfer	75
9.1.8	Diagnostics	75
9.1.8.1	EtherCAT master diagnostics	75
9.1.9	Error scenarios	83
9.1.9.1	"Pre-Operational" EtherCAT state is not achieved	83
9.1.9.2	"Operational" EtherCAT state is not achieved	83
9.1.9.3	The EtherCAT master reports "SYNC error - BusCycleTask is not in-sync"	83
9.1.9.4	A slave does not accept a cyclic frame	83
9.1.9.5	The sync manager configuration is invalid	83
9.1.9.6	The I/O configuration is invalid	84
9.1.9.7	Error during process data transfer	84
9.1.9.8	The network cable is not connected	84
9.1.9.9	A sent frame is not returned to the master	84
9.1.9.10	The output shafts make a cracking sound	85
9.1.9.11	The drive shafts do not rotate	85
9.1.10	Advanced configuration	86
9.1.10.1	Device identification	86
9.1.10.2	Synchronisation with "distributed clocks" (DC)	87
9.1.11	Modular machine configuration	91
9.1.11.1	Behavior of the EtherCAT master	91
9.1.11.2	Mandatory slaves/Optional slaves	92
9.1.11.3	Configuration files	93
9.1.11.4	Address assignment	95
9.1.11.5	Error messages	96
9.2	EtherCAT slave	98
9.2.1	Commissioning	100
9.2.1.1	EtherCAT device configuration with »PLC Designer«	100
9.2.1.2	EtherCAT-Slave configuration in Beckhoff TwinCAT 3.x®	101
9.2.1.3	Device description file	101
9.2.2	Process data transfer	101
9.2.3	Parameter data transfer	102
9.2.4	EtherCAT I/O mapping status	103
9.2.5	Diagnostics	104
9.2.5.1	Status LEDs	104
9.2.5.2	EtherCAT device diagnostics	104
9.2.6	Error scenarios	105
9.2.6.1	No EtherCAT module plugged or detected	105
9.2.6.2	Process data mapping in master / slave does not match	105

Contents

9.3	PROFINET IO-Device.....	106
9.3.1	Commissioning.....	109
9.3.1.1	Restarting or stopping the communication.....	109
9.3.1.2	Settings in the Siemens »TIA Portal«.....	110
9.3.1.3	Device description file.....	110
9.3.2	Basic setting and options.....	111
9.3.2.1	Station name and IP configuration.....	111
9.3.2.2	Suppress diagnostic messages to the IO controller.....	112
9.3.3	Process data transfer.....	112
9.3.4	Parameter data transfer.....	113
9.3.5	Monitoring.....	114
9.3.6	Diagnostics.....	115
9.3.6.1	Status LEDs.....	115
9.3.6.2	PROFINET IO-Device diagnostics.....	115
10	Configuring the firewall.....	117
11	Configuring OPC UA.....	126
11.1	OPC UA server.....	127
11.1.1	Basic setting.....	127
11.1.2	Diagnostics.....	127
11.1.2.1	Active OPC UA server settings.....	127
11.1.2.2	OPC UA server diagnostics.....	128
11.2	OPC UA client.....	129
11.3	OPC UA PubSub.....	130
11.3.1	Basic setting.....	130
12	Device functions.....	131
12.1	Device identification.....	131
12.2	Optical device identification.....	132
12.3	Switch-off behavior.....	133
12.3.1	Retain variables and persistent variables.....	133
12.4	Reset controller.....	134
12.5	Back up and restore data.....	135
12.5.1	Back up data.....	136
12.5.2	Restore data.....	138
12.6	Update firmware.....	140
13	Replace controller.....	142
13.1	Dismount controller.....	143
13.2	Install new controller.....	144
13.3	Reuse retain data.....	145

14	Diagnostics and fault elimination	146
14.1	Status LEDs	147
14.2	Logbook	148
14.3	Diagnostic parameters	149
14.3.1	PLC diagnostics	149
14.3.2	Network diagnostics	151
14.3.3	Service life diagnostics	151
14.4	PLC core dump	152
14.5	Event handling	153
14.5.1	Severity	153
14.5.2	Event reset	153
14.6	Events, causes and remedies	154
14.6.1	Event ID overview	154
14.6.2	Causes and remedies	158
15	Technical data	186
15.1	Standards and operating conditions	186
15.1.1	Conformities and approvals	186
15.1.2	Protection of persons and device protection	186
15.1.3	EMC data	186
15.1.4	Environmental conditions	187
15.2	Rated data	188
16	Environmental notes and recycling	189
17	Appendix	190
17.1	Parameter attribute list	190



1 About this document

These instructions apply to the c550 controller.

If you commission a controller together with other devices (e. g. I/O system, inverter, other network components), please observe the documentation for the other devices in the automation system as well.

WARNING!

Read this documentation carefully before starting any work.

- ▶ Please observe the safety instructions!
-



1.1 Document description

This documentation is valid up to firmware version:

Firmware version	Date	Internal data ID
c550_v1.11.0.2	2023-10-05	V_1_11_0



1.2 Further documents

More information

For certain tasks, information is available in other media.

Medium	Contents/topics
Engineering Tools	For commissioning
AKB articles	Additional technical information for users in the Application Knowledge Base
CAD data	Download in different formats from the EASY Product Finder
EPLAN macros	Project planning, documentation and management of projects for EPLAN P8.
Device descriptions	Standardized files for network configuration



A detailed description of the EtherCAT modules can be found on the Internet:
www.Lenze.com → Downloads



Information and tools with regard to the Lenze products can be found on the Internet:
www.lenze.com → Downloads



1.3 Notations and conventions

Conventions are used in this document to distinguish between different types of information.

Numeric notation		
Decimal separator	Point	Generally shown as a decimal point. Example: 1 234.56
Warnings		
UL Warnings	UL	Are used in English and French.
UR warnings	UR	
Text		
Engineering Tools	" "	Software Example: "Engineer", "EASY Starter"
Icons		
Page reference		Reference to another page with additional information. Example: 16 = see page 16
Documentation reference		Reference to other documentation with additional information. Example: EDKxxx = see documentation EDKxxx

Layout of the safety instructions

DANGER!

Indicates an extremely hazardous situation. Failure to comply with this instruction will result in severe irreparable injury and even death.

WARNING!

Indicates an extremely hazardous situation. Failure to comply with this instruction may result in severe irreparable injury and even death.

CAUTION!

Indicates a hazardous situation. Failure to comply with this instruction may result in slight to medium injury.

NOTICE

Indicates a material hazard. Failure to comply with this instruction may result in material damage.



2 Safety instructions

2.1 Basic safety instructions

Disregarding the following basic safety instructions and safety information may lead to severe personal injury and damage to property!

- Only use the product as directed.
- Never commission the product in the event of visible damage.
- Never modify the product technically.
- Never commission the product before assembly has been completed.
- Never operate the product without the required covers.
- Connect/disconnect all pluggable connections only in deenergized condition!
- Only remove the product from the installation in the deenergized state.
- The product can – depending on their degree of protection – have live, movable or rotating parts during or after operation. Surfaces can be hot.
- Observe the specifications of the corresponding documentation. This is the condition for safe and trouble-free operation and the achievement of the specified product features.
- The procedural notes and circuit details given in the associated documentation are suggestions and their transferability to the respective application has to be checked. The manufacturer of the product does not take responsibility for the suitability of the process and circuit proposals.
- All work with and on the product may only be carried out by qualified personnel. IEC 60364 and CENELEC HD 384 define the qualifications of these persons:
 - They are familiar with installing, mounting, commissioning, and operating the product.
 - They have the corresponding qualifications for their work.
 - They know and can apply all regulations for the prevention of accidents, directives, and laws applicable at the place of use.

Please observe the specific safety information in the other sections!



2.2 Application as directed

- The product is a professional equipment intended for use by trades, specific professions or industry and not for sale to the general public. IEC 60050 [IEV 161-05-05]
- To prevent personal injury and damage to property, higher-level safety and protection systems must be used!
- All transport locks must be removed.
- The product may only be operated under the specified operating conditions and in the specified mounting positions.
- The product is only suitable for installation in control cabinets and, depending on the protection class and version, for wall mounting or support arm mounting.
- The product may only be operated to implement control concepts, operating concepts or to display information.
- The product must not be operated in private areas, in potentially explosive atmospheres and in areas with harmful gases, oils, acids and radiation.



2.3 Residual hazards

Even if notes given are taken into consideration and protective measures are implemented, the occurrence of residual risks cannot be fully prevented.

The user must take the residual hazards mentioned into consideration in the risk assessment for his/her machine/system.

If the above is disregarded, this can lead to severe injuries to persons and damage to property!

Product

Observe the warning labels on the product!



Dangerous electrical voltage:

Before working on the product, make sure there is no voltage applied to the power terminals! After mains disconnection, the power terminals will still carry the hazardous electrical voltage for the time given next to the symbol!



Electrostatic sensitive devices:

Before working on the product, the staff must ensure to be free of electrostatic charge!



High leakage current:

Carry out fixed installation and PE connection in compliance with:
EN 61800-5-1 / EN 60204-1



Hot surface:

Use personal protective equipment or wait until the device has cooled down!

NOTICE

Short circuit in the device due to a missing cover.

Destruction of the device.

- ▶ Close the modules with the contact cover.

NOTICE

Incorrect arrangement of the I/O modules.

Malfunction of the device.

- ▶ Arrange the modules from left to right on the device.
- ▶ Start with a power supply module or an I/O bus coupler.

NOTICE

Free spaces on the backplane bus.

Malfunction on the backplane bus due to free spaces between the modules.

- ▶ Connect the modules directly in succession.

NOTICE

Short circuit in the device due to incorrect handling.

Destruction of the device.

- ▶ Only plug in and remove the controller and modules of the I/O system 1000 when the supply voltage is switched off.



3 Product information

3.1 Identification of the products

Each device is fitted with a nameplate containing the type code and other information.

Type code structure

		C	5	5	A	E	4	0	□	0	0	A	□	1	0	□□□	S
Product type	Cabinet Controller	C															
Product family	c500		5														
Product	c550			5													
Product generation	Generation 1				A												
Mounting type	Control cabinet mounting					E											
Processor	Intel® Core™ i7 2.8 GHz						4										
Degree of protection	IP20							0									
Fieldbus network 1	Without communication								0								
	EtherCAT slave									T							
	PROFINET IO-Device										R						
Fieldbus network 2	Without communication										0						
-	-											0					
Runtime	FAST runtime												A				
Visualization	Without visualization													0			
	FAST UI runtime														1		
SD card size	512 MB														1		
-	-															0	
SD card/Application Credit	SD card with																
	0 Application Credit																00Z
	50 Application Credit																001
	100 Application Credit																002
	150 Application Credit																003
	200 Application Credit																004
	300 Application Credit																005
	400 Application Credit																006
	500 Application Credit																007
	600 Application Credit																008
	700 Application Credit																009
	1000 Application Credit																00A
	1200 Application Credit																00G
	1500 Application Credit																00B
	2000 Application Credit																00C
	2500 Application Credit																00D
	3000 Application Credit																00E
4000 Application Credit																00F	
-	-																S



3.2 Features

The following figure provides an overview of the elements and connections on the device. Position, size and appearance of elements and connections may vary depending on the options selected for the device.

Controller c550

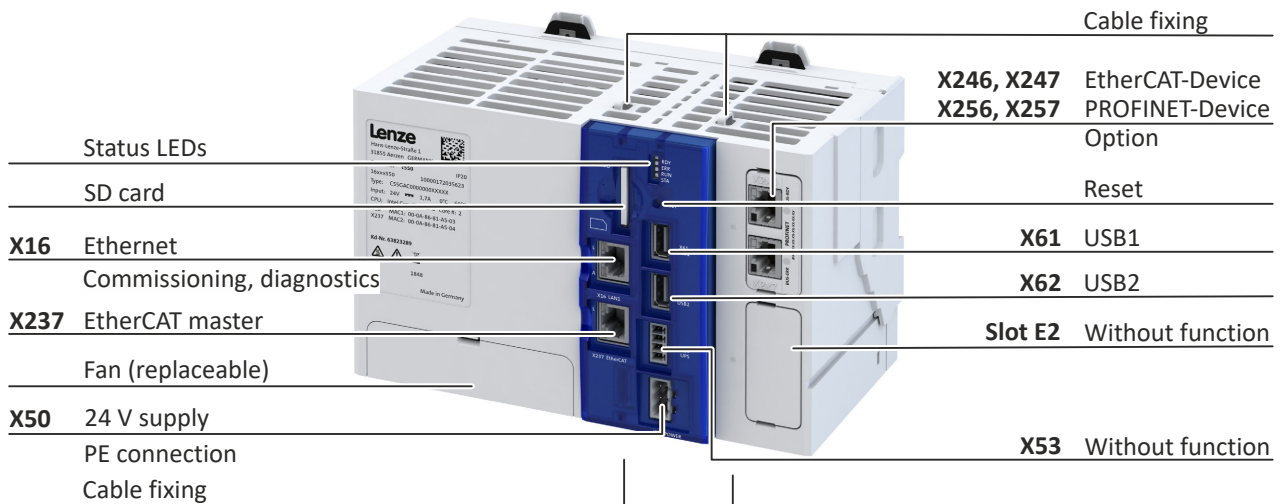



3.3 SD card

An already inserted SD card is included in the scope of supply of the controller.

The combination of control technology software and application data on the SD card ensures that the data match the prevailing application in the present version. The SD card serves to easily exchange data in a different device.

The SD card is used as memory for the following application data:

- PLC boot project with parameter description
- Application credit for the FAST application software
- Retain and logbook data
- User data (SD card/userData folder)
- Open source license description

Notes:

- The controller only works with a plugged-in SD card!
- Removal of the SD card while the controller is running will lead to a system failure!
- The SD card is required for the system start since it contains the system files for the starting process.
- If the SD card has been temporarily removed, the controller must be restarted to access the SD card again!
- Only use SD cards provided by Lenze. Only these SD cards have the corresponding licensing.

The operating system of the controller and the application software »FAST« are stored in the internal flash memory of the controller.



For using a firmware update, include a memory reserve of 200 MB on the SD card!

Diagnostic parameter

Address	Name / setting range / [default setting]	Information	
0x2012:001	Device information: SD card status <ul style="list-style-type: none">• Read only	Display whether an SD card is inserted.	
	0 No SD card connected		
	1 SD card connected		
0x2012:004	Device information: SD card total memory <ul style="list-style-type: none">• Read only	Display of the total memory capacity of the SD card in kilobytes.	
0x2012:005	Device information: SD card free memory <ul style="list-style-type: none">• Read only	Display of the currently free memory on the SD card in kilobytes.	
0x2012:006	Device information: SD card used memory <ul style="list-style-type: none">• Read only: x kB	Display of the currently occupied memory on the SD card in kilobytes.	



3.4 Application Credit

The controller uses a points system, the so-called “Application Credit”, as a license model for certain functions. The amount of Application Credit required is calculated based on the functions required for your application. An SD card with sufficient Application Credit must be inserted in the controller to execute these functions without restriction. SD cards with different amounts of Application Credit can be purchased directly with the controller or separately from Lenze.

Functions that require an Application Credit are for example:

- Motion functions of the FAST Application Software
- OPC UA
- EASY UI clients



The following Application Knowledge Base article lists which functions require how much Application Credit:

[Overview of the Application Credits](#)

Diagnostic parameter

Address	Name / setting range / [default setting]	Information
0x2012:002	Device information: Application Credit available <ul style="list-style-type: none">• Read only	Display of the application credit available on the SD card
0x2013:002	Application information: Application Credit required <ul style="list-style-type: none">• Read only	Display of the application credit required for the loaded application.



3.5 Backplane bus

The I/O system 1000 can be directly connected to the integrated backplane bus. The individual modules of the I/O system are parameterized in the »PLC Designer«.



Only EPM-Sxxx I/O compound modules from hardware version 1B onwards are supported.

Detailed information on the I/O system 1000 can be found in the corresponding documentation: www.Lenze.com → Downloads



When using I/O terminals on the backplane bus, the **EPM-S701** power supply module is required as the first module.

Product information

Engineering tool »PLC Designer«



3.6 Engineering tool »PLC Designer«

The "PLC Designer" is a PC software for program creation and commissioning of Lenze PLC devices according to IEC 61131-3.

In addition, the "PLC Designer" offers 6 editors, debugger, monitoring and other features.

- »PLC Designer« [Download](#)



3.7 License information



Lenze Software may contain software elements that are licensed as free software or open source. The licensing terms and conditions of the open source software components used in this product can be found in the "License" directory on the SD card included in the product.

PROFINET



The PROFINET firmware is optional.

The PROFINET firmware uses the following open source software packages under a modified GPL license: eCos Operating System. These components are used at the operating system level of the firmware. The protocol stack does not use source code under a GPL license.

View license: <http://ecos.sourceforge.org/license-overview.html>



4 Mechanical installation

4.1 Dimensions



The specified installation clearances are minimum dimensions to ensure a sufficient air circulation for cooling purposes. They do not consider the bend radiuses of the connecting cables.

The dimensions in mm apply to:

	c550
Weight	1.45 kg

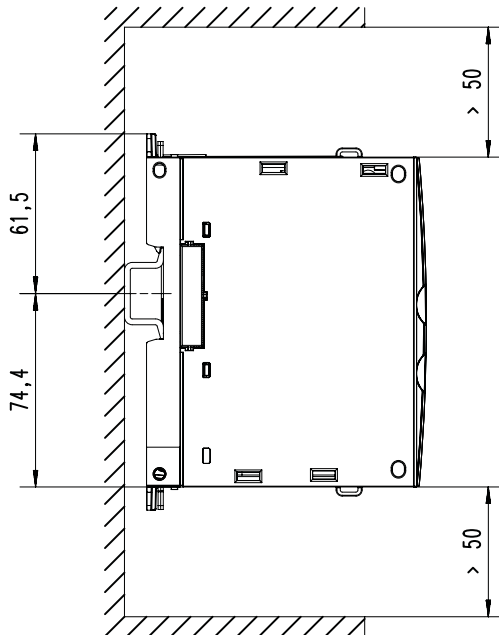
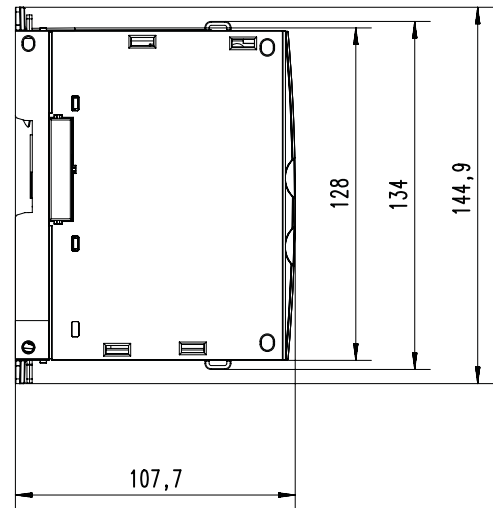
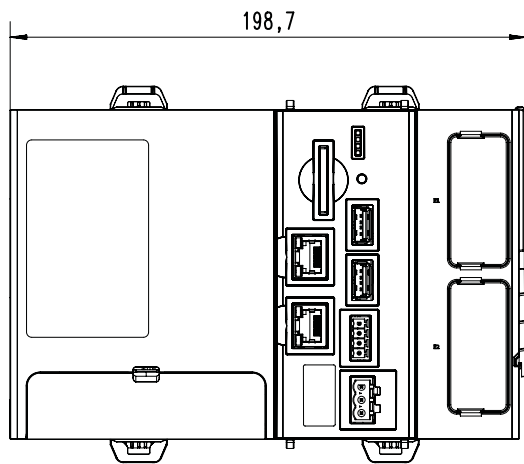

8801746-00



Mechanical installation

Dimensions

The dimensions in inch apply to:

	c550
Weight	1.45 kg

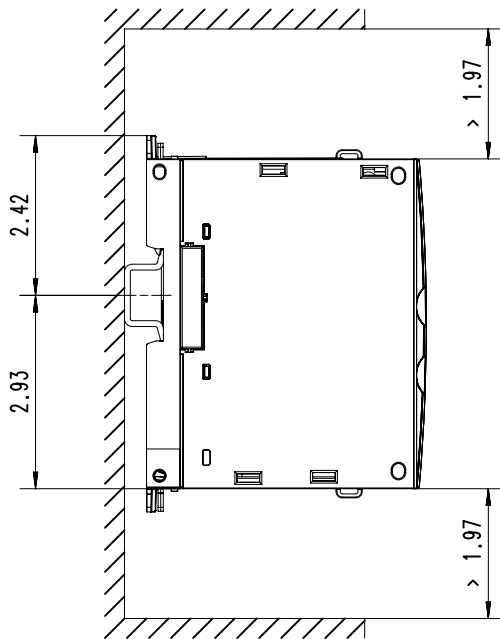
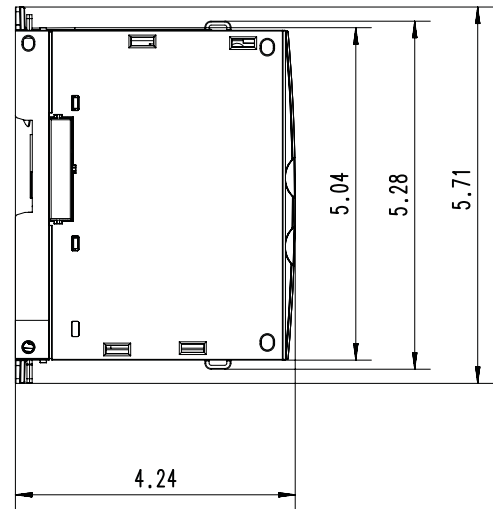
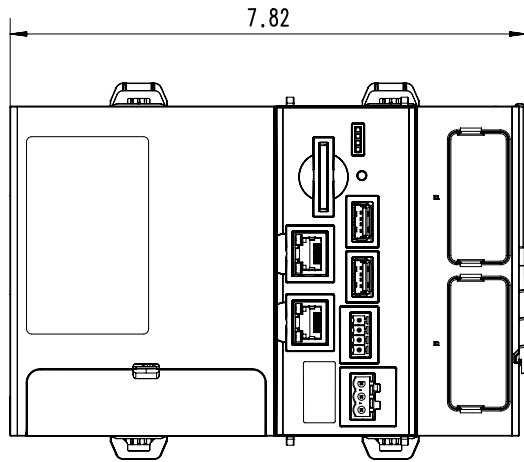

8801747-00



4.2 Mounting the controller

Mounting conditions

- Mounting place: In the control cabinet (indoor use)
- Mounting position: Horizontal
- Mounting type: DIN rail mounting
- Mounting clearance: above 50 mm, below 50 mm

Mounting and dismounting the controller





4.3 Mounting the I/O system 1000

Mounting and dismounting the I/O system 1000 and the cover

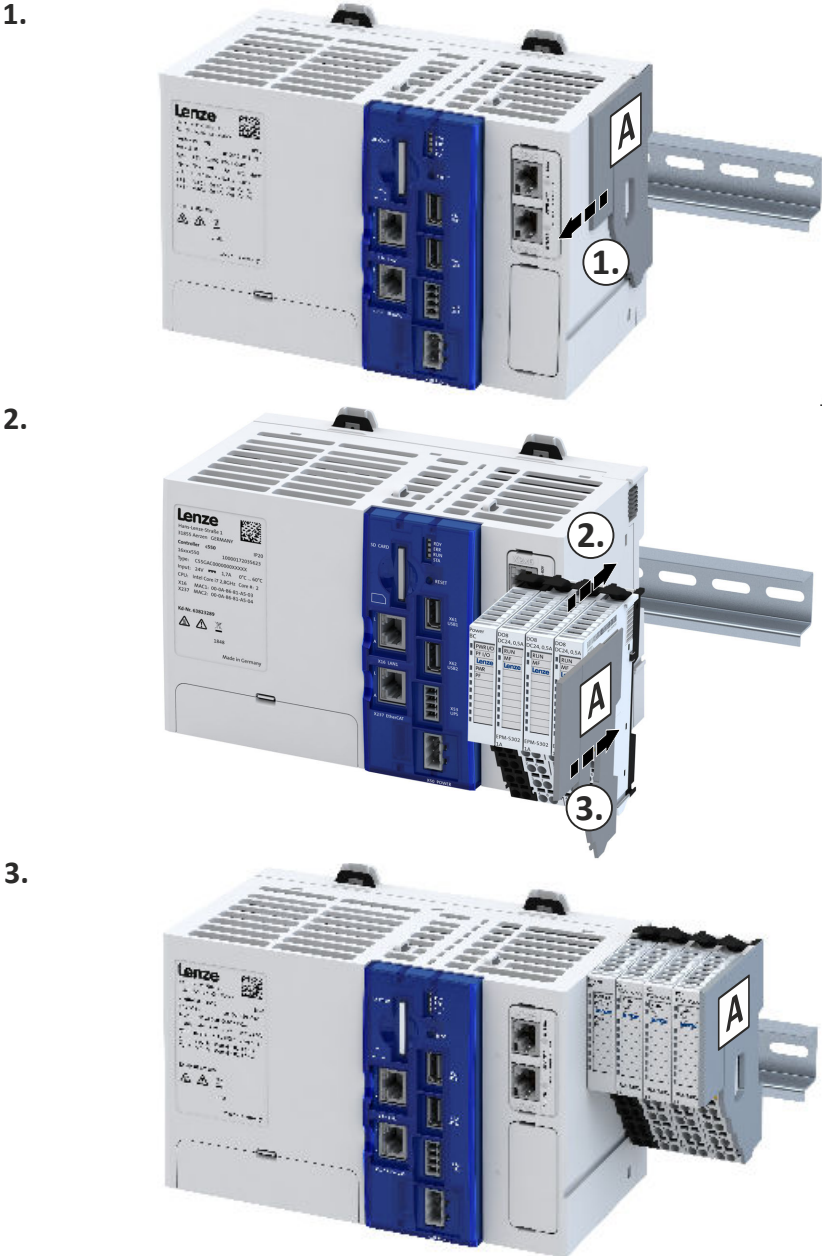



5 Electrical installation

5.1 Important notes

⚠ WARNING!

Dangerous electrical voltage

Error on device leads to overvoltage in the system.

- ▶ For a voltage supply with 24 V DC ($\pm 25\%$), use a safely separated power supply unit according to the applicable SELV/PELV requirements.
 - ▶ All components connected to USB and RJ45 must be electrically isolated from the mains according to class III.
 - ▶ All electronic devices in the control system must be properly grounded. Grounding must be effected in accordance with the applicable regulations.
-

NOTICE

High input voltage at the device

Possible consequences: Destruction of the device

- ▶ Observe maximum permissible input voltage.
 - ▶ Fuse device at the input against too high input voltage.
-

NOTICE

Short circuit at the device due to electrostatic discharge

Possible consequences: Destruction of the device

- ▶ The personnel must be free of electrostatic charge prior to working on the device.
-

NOTICE

Unstable LAN connection due to the use of incorrect cable types

Possible consequences: LAN connection interruption

- ▶ Exclusively use cables of the CAT5-S/FTP type or better.
 - ▶ The unit is to be connected only to internal Ethernet networks without exiting a facility and being subjected to TNVs.
-

NOTICE

Unstable USB connection due to USB cable being too long

Possible consequences: Interruption of the USB connection

- ▶ The length of the USB cable must not exceed 3 m.
-



5.2 Mains connection



If the PE conductor is not supplied with the power supply, the PE potential must be connected to a grounding point near the mounting location.



Please note the following:

The controller starts as soon as the supply voltage is applied.

After switching off the supply voltage, the controller automatically saves the retain data and then switches itself off.

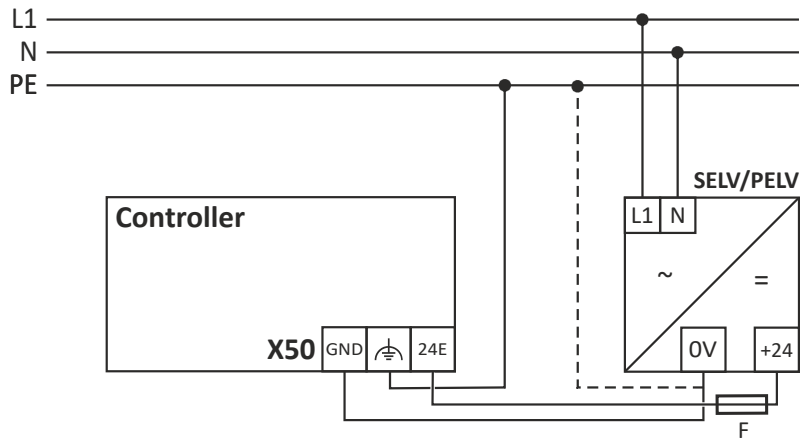

X50	Connection	Connection type	Max. connection cross-section
	Mains connection 24 V DC	3-pole socket with 3.5 mm pitch	2.5 mm ² AWG14



5.3 Networks



Tensile stress and vibrations lead to an unstable network connection.

- Lay the network cables in a semicircle and secure the network cables to the lashing eyes.
- Observe the bending radii of the network cables.



Fig. 1: Installation and fixing of the network cables



6 Commissioning

This chapter contains information on how to commission and integrate the controller into an automation system.

Required accessories

- Engineering PC with »PLC Designer« installed.
- Standard network cable

Commissioning

Installation of »PLC Designer«



6.1 Installation of »PLC Designer«

For the installation, download the »PLC Designer« from the download area on the Lenze homepage to your PC and run the setup file.

www.Lenze.com → Downloads



6.2 Commissioning steps

Recommended sequence of the commissioning steps

1. ▶ [Connect controller and Engineering PC](#) [32](#)
2. ▶ [Set IP address on the PC](#) [33](#)
3. ▶ [Start controller](#) [34](#)
4. ▶ [Create PLC program](#) [36](#)
5. ▶ [Create task](#) [37](#)
6. ▶ [Compile PLC program code](#) [38](#)
7. ▶ [Establish connection between controller and »PLC Designer«](#) [39](#)
8. ▶ [Log in to the controller \(load configuration\)](#) [40](#)
9. ▶ [Parameterize controller](#) [41](#)
10. ▶ [Device name](#) [46](#)
11. ▶ [Start PLC program](#) [44](#)



6.3 Connect controller and Engineering PC

A communication link from the engineering PC to the controller is required to commission the controller with the »PLC Designer«. This communication link must be wired.

Connect the engineering PC to the engineering port **X16** of the controller using a network cable.



By default, the IP address **192.168.5.99** is preset for the engineering port to enable fast commissioning.

If you want to change the IP address, you can find more information in the chapter "[Configure engineering port](#)". [58](#)

The accessibility of the controller can be tested via a ping command on the console with the preset IP address 192.168.5.99 or the newly configured IP address.



6.4 Set IP address on the PC



Recommended IP address of the engineering PC: 192.168.5.100

Standard IP address of the engineering port **X16** on the controller: 192.168.5.99

How to set the static IP address of the Engineering PC:

Preconditions

- Direct connection between the engineering PC and the controller

1. Open the Network connections diagnostics window.

Control Panel\Network and Internet\Network Connections

2. Select the network interface which is connected to the controller.

3. Right-click on **Properties**.

4. Select **Internet Protocol (TCP/IP)**.

5. Click on the **Properties** button.

6. Select the **Alternate Configuration** tab.

7. Select the **User-defined** option.

a) Enter the IP address of the engineering PC that matches the IP range of the controller.

b) Enter the subnet mask of the engineering PC.

8. Click **OK** to close the dialog box.



6.5 Start controller

Preconditions

- SD card is inserted.
- Controller is supplied with voltage via the terminal **X50**.
- If I/O system 1000 modules are used, these must be installed on the backplane bus before the start-up.



The controller requires approx. 30 seconds to start up.

The starting sequence is displayed in the LED blinking pattern. When the device is ready for operation, the "RDY" LED lights up in blue.

If there is a boot project on the SD card, the corresponding PLC project is started. The status is indicated by the "RUN" LED.

An error is indicated by the "ERR" LED. Details about the error can be found in the status information in the device and in the logbook. [▶ Status LEDs ¶ 147](#)

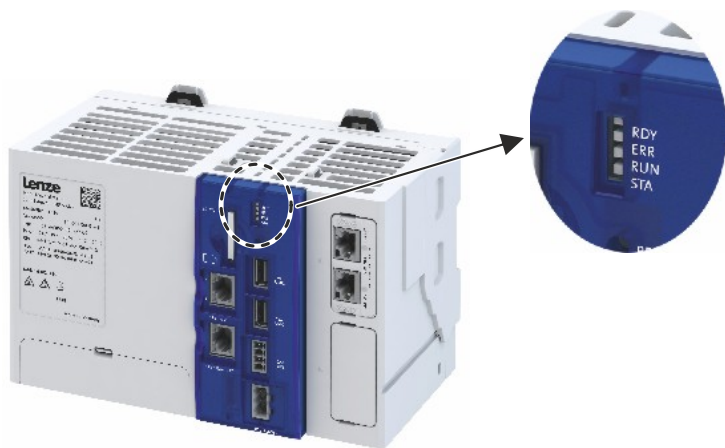

LED "RDY" (blue/yellow)	Meaning
Off	Device is switched off.
	Device starts.
	Device is ready for operation.
	Value has fallen below the voltage
	System time must be set. ▶ Time ¶ 49
	Reset key was pressed during the boot process.

"RUN" LED (yellow/green)	Meaning
	PLC project is being loaded.
	PLC project is stopped.
	PLC project is started.



6.6 Access to SD card

The »PLC-Designer« provides access to the SD card.

How to use the »PLC-Designer« to access the SD card:

Preconditions

- »PLC-Designer« is running.
 - SD card is inserted.
1. Select the controller.
 2. Select the **Files** tab in the project tree.
 3. Click the update symbol.

The SD card directory is displayed.



You can also use an sftp connection to access the SD card.

You will find information on establishing a connection in the Lenze Knowledge Base:
www.Lenze.com.



The SD card's write protection must not be active for use in the controller.

If write protection is activated, the PLC application will not start. Retain, boot project and logbook information will not be saved.



Only use SD cards provided by Lenze. Only these SD cards have the corresponding licensing.



6.7 Create PLC program

How to create a PLC program in the target system:

Preconditions

- »PLC Designer« has been started. ▶ [Start controller](#) 34
 - A new project has been created or a technology FAST application template has been opened.
1. Select the **Add Device** menu command.
 2. Select the controller.
 3. Add the backplane bus I/O modules.
 4. Add the network module.

Add Device ✕

Name:

Action: Append device Insert device Plug device Update device

String for a fulltext search Vendor: <All vendors>

Name	Vendor	Version	Description
PLCs			
SoftMotion PLCs			
Controller 3200C	Lenze	3.18.0.0	Controller 3200C for all applications (Logic and Motion)
Controller 3200C Web-Visu	Lenze	3.17.2.6	Controller 3200C for all applications (Logic and Motion) with web visualization
Controller 3241C	Lenze	3.18.0.0	Controller 3241C for all applications (Logic and Motion)
Controller 3241C Web-Visu	Lenze	3.17.2.6	Controller 3241C for all applications (Logic and Motion) with web visualization
Controller c300	Lenze	3.18.0.0	Controller c300 for all applications (Logic and Motion)
Controller c520	Lenze	1.3.0.8	Controller c520 for all applications (Logic and Motion)
Controller c550	Lenze	1.3.0.0	Controller c550 for all applications (Logic and Motion)
Controller c750	Lenze	1.2.0.2	Controller c750 for all applications (Logic and Motion)
i950	Lenze	1.0.5.0	i950 based on FW Version 1.0.x.x
i950 (Safety STO)	Lenze	1.3.7.8	i950 (Safety STO) based on FW Version 1.3.x.x
i950 ES (extended Safety)	Lenze	1.3.7.8	i950 ES (extended Safety) based on FW Version 1.3.x.x
Panel Controller p300	Lenze	3.18.0.0	Panel Controller p300 for Logic applications
Panel Controller p500	Lenze	3.18.0.0	Panel Controller p500 for all applications (Logic and Motion)
Panel Controller p500 Web-Visu	Lenze	3.17.2.6	Panel Controller p500 for all applications (Logic and Motion) with web visualization

Group by category Display all versions (for experts only) Display outdated versions

Name: Controller c550
Vendor: Lenze
Categories: PLCs
Version: 1.3.0.0
Order Number: LPC 1000
Description: Controller c550 for all applications (Logic and Motion)

Add selected device to the project (top-level)

i (You can select another target node in the navigator while this window is open.)



6.8 Create task

How to create a task:

Preconditions:

- PLC program is created in the target system. ▶ [Create PLC program](#) 36
1. In the context menu of the **Task configuration**, select the **Add object/Task** command.
A task is created.
 2. Enter a cycle time for the created task.



If the EtherCAT master is used:

The task cycle time of the main program part must correspond to the set DC cycle time.

The task priority of the EtherCAT BusCycleTask must have the highest priority so that it cannot be displaced by other IEC tasks and lose its synchronism.

3. In the context menu for **Application**, select the command **Add Object**.
A program block is created in the application.
4. Select the **Add call** button.
A dialog opens.
5. Select the program call under **Application** and confirm with **OK**.



6.9 Compile PLC program code



The parameterization for the device is created automatically in the background when the PLC program code is compiled.

How to compile the PLC program code:

Preconditions

- A task has been created.
1. Confirm with the **Build Compile** menu command or with the **<F11>** function key.
 2. If no errors have occurred during the compilation process, save the »PLC Designer« project in the project folder.

The parameter list is shown in the Controller tab. Detailed parameterization adjustments can be made there. ▶ [Parameterize controller](#)  41



If errors occurred during the compilation process, they can be located and corrected on the basis of the »PLC Designer« error messages. Subsequently, re-compile the program code.



6.10 Establish connection between controller and »PLC Designer«

How to connect the »PLC Designer« with the controller:

Preconditions

- The PLC program code has been compiled.
1. Go to the **Communication settings** tab of the target system (device) and click the **Add gateway** button.
 2. Enter the IP address of the controller in the **Gateway** dialog box.
 3. Click **OK** to confirm the entry.
 4. Click the **Scan network** button.
 5. Select the controller for the IP address entered and confirm by clicking the **Set active path** button.

The controller is now connected with the »PLC Designer« and appears in the project tree under its assigned name. If a device name has not yet been assigned in the project (standard name = "Device"), the device will be displayed with its device type and MAC address in the default setting.

Example: "c550-000A86123456"

Commissioning

Log in to the controller (load configuration)



6.11 Log in to the controller (load configuration)

How to use the »PLC-Designer« to log into the controller:

Preconditions

- A connection between the controller and the »PLC-Designer« has been established.

1. Use the **Online Login** menu command or **<Alt>+<F8>** to log into the controller.

Logging in serves to load the device parameterization and the PLC program into the controller.

Any existing configuration or PLC program is overwritten.



6.12 Parameterize controller

6.12.1 General information on parameter setting

The controller can be parameterized in individual functions. The basic structure of the parameters is described in the following. The parameter list of the device is only available after the PLC program has been compiled. This list can be found as a tab under the controller in the PLC project tree of the »PLC-Designer«.



Certain device commands or settings which might cause a critical state of the drive behavior can only be carried out when the device is disabled.



User parameters may only be created in a program POU.

6.12.1.1 Addressing of the parameters

Each parameter features a 16-bit index as its address. Under this address, the parameter is stored in the object directory of the device.

- Parameters that belong together functionally are combined in a data set. These parameters are additionally provided with an 8-bit subindex.
- The colon is used as a separator between the index and subindex Example: "0x2540:001"
- There are parameter settings that can be changed, and (diagnostic) parameters that can only be read.



The following conventions are used in this documentation for specifying the parameter address:

- The index is specified as a hexadecimal value.
 - The subindex is specified as a decimal value.
-

Commissioning

Parameterize controller
 Saving the parameter settings
 Structure of the parameter descriptions



6.12.1.2 Structure of the parameter descriptions

- The parameter descriptions in this documentation are structured in table form.
- The representation distinguishes parameters with a setting range, text, selection list, and bit-coded display.
- The default setting of parameters with a write access feature is shown in **bold**.

Example: parameters with a setting range

Address	Name / setting range / [default setting]	Information
Index:Subindex	Parameter designation Minimum value ... [default setting] ... maximum value • Optional information with regard to the parameter.	Explanations & notes with regard to the parameter.

Example: parameters with a selection list

Address	Name / setting range / [default setting]	Information
Index:Subindex	Parameter designation • Optional information with regard to the parameter.	Explanations & notes with regard to the parameter. Note: The corresponding selection number (here 0, 1, or 2) must be set. Other values are not permissible.
	0 Designation of selection 0	Optionally: Explanations & notes with regard to the corresponding selection.
	1 Designation of selection 1	The default selection is shown in bold .
	2 Designation of selection 2	

Example with bit coded display

Address	Name / setting range / [default setting]	Information
Index:Subindex	Parameter designation • Optional information with regard to the parameter.	Explanations & notes with regard to the parameter.
	Bit 0 Designation of bit 0	Optionally: Explanations & notes with regard to the corresponding bit.
	Bit 1 Designation of bit 1	
	Bit 2 Designation of bit 2	
	
	Bit 15 Designation of bit 15	

6.12.2 Saving the parameter settings

Use the "Save user data" device command to save the parameter settings of the controller locally on the SD card of the device.

The parameters are part of the boot application. When creating the boot application, the parameter settings are saved automatically on the SD card of the device.

Parameter

Address	Name / setting range / [default setting]	Information
0x2022:003	Device commands: Save user data	The parameter settings are saved on the SD card. • When the device command has been executed successfully, the value 0 is shown. • Do not switch off the supply voltage or remove the SD card from the controller during the storage process! • When the controller is switched on, all parameter settings are automatically loaded from the SD card into the RAM memory of the controller.
	0 Off / ready	Only status feedback
	1 On / start	Execute device command
	2 In progress	Only status feedback
	3 Action cancelled	
	4 No access	
	5 No access (Device disabled)	
	101 No SD card connected	
	102 SD card is write protected	
	103 SD card is full	



6.12.3 Reset parameters to default

Use the "Load default settings" device command to reset the parameters to the default setting.



By executing this device command, all parameter settings made by the user are temporarily lost!

If the changes are not saved, the parameters stored on the SD card will not be changed.

Parameter

Address	Name / setting range / [default setting]	Information
0x2022:001	Device commands: Load default settings <ul style="list-style-type: none"> Settings can only be changed if the PLC application is not in the "Running" status. 	All parameters in the RAM memory of the controller are reset to the default setting that is stored in the controller firmware as default setting. <ul style="list-style-type: none"> All parameter changes made by the user are lost during this process! When the device command has been executed successfully, the value 0 is shown. Loading parameters has a direct effect on cyclic communication: The data exchange for control is interrupted and a communication error is generated.
	0 Off / ready	Only status feedback
	1 On / start	Execute device command
	2 In progress	Only status feedback
	3 Action cancelled	
	4 No access	
5 No access (Device disabled)		
0x2022:039	Device commands: Load TA default settings	All controller parameters are reset to the default setting. Parameters that are declared separately in the application are set to the corresponding standard values from the technology application. <ul style="list-style-type: none"> All parameter changes made by the user are lost during this process! When the device command has been executed successfully, the value 0 is shown.
	0 Off / ready	Only status feedback
	1 On / start	Execute device command
	2 In progress	Only status feedback
	3 Action cancelled	
	4 No access	
5 No access (Device disabled)		



6.13 Start PLC program

How to start the PLC program:

Preconditions

- The »PLC Designer« is connected to the controller and the current PLC program has already been transferred.
1. Use the menu command **Debug -->Start** or the function key **<F5>** to start the PLC program.

The "RUN" LED indicates the status of the PLC project.

"RUN" LED (yellow/ green)	Meaning
■ ■ ■ ■	PLC project is being loaded.
■	PLC project is stopped.
■	PLC project is started.



6.14 Generate boot application

An executable PLC program can be executed when the controller is started.

To do so, a boot application must have been created using the »PLC-Designer« The boot application also stores the parameter set on the SD card of the controller.

Device settings

Device name



7 Device settings

7.1 Device name

Device identification is provided by the device name of the controller. If the preset name of the controller is modified in the »PLC-Designer« project tree, this name will also be used in the **Device name** parameter. [▶ 0x2001](#)

The device name is also used as the network name, which is displayed when **Scanning the network**.

Example

If the device name **Device** is changed to a new name, this modification will also be active in the network name.



The device name change must be considered when restoring communication to the controller.

Parameter

Address	Name / setting range / [default setting]	Information
0x2001	Device name ["My Device"]	Any device name can be set in this object for the purpose of device identification.



7.2 Host name

The host name of the controller is the name of the controller in the network. This name cannot be changed. The name is composed of the controller type and the unique Ethernet MAC address. The host name is only required when using additional network services. The device name is required to communicate with the engineering PC. ▶ [Device name](#) 46

Parameter

Address	Name / setting range / [default setting]	Information
0x2014:001	General network identification: Hostname • Read only	Display of the name of the controller in the network



7.3 Name server addresses

Two corresponding name servers can be entered via IP address for name resolution if network functions are used.



For safety reasons, the Ethernet access must not be connected directly to the Internet. The specified Domain Name Server must be in the local network or available from the local network.

Please observe the firewall settings of the network.

Parameter

Address	Name / setting range / [default setting]	Information
0x2459:001	Name server addresses: Name server address 1 • Read only	Specification of an IP address for a Domain Name Server (DNS). • As a function of the DHCP setting, the setting of the name server address only becomes effective when the device is restarted.
0x2459:002	Name server addresses: Name server address 2 • Read only	



7.4 Time

The controller has two times of day: system time and local time. Both times are interlinked via the set time zone.

System time

The system time of the device is the time base for all the time-dependent actions of the controller. The operating system receives the system time via a maintenance-free clock chip (CMOS-RTC time).

The system time should correspond to the international UTC world time. The device saves the system time internally. If the controller is in a deenergized state, the system time is maintained for approx. 14 days. After this time has elapsed, the time will need to be set. A battery is not required.

The system time can be specified manually or via an NTP server.

- System time - Source ▶ [0x245B:001](#)
- System time - Time ▶ [0x245B:002](#)
- NTP - Server addresses ▶ [0x245A:002 ... 0x245A:005](#)

Local time

The local time is based on the system time. Together with the selected time zone, it is used to specify the local time. The local time can be used, for instance, to provide current events in the logbook with time information.

- Time zone ▶ [0x245C:001](#)
- Local time ▶ [0x245C:002](#)



Set the system time and the required time zone for the site of the controller during commissioning. The local time will then be calculated automatically.

Parameter

Address	Name / setting range / [default setting]	Information
0x245B:001	System time: Setting method	Selection of the time base for the system time of the device.
	0 NTP server	The system time is obtained from an NTP server. <ul style="list-style-type: none"> • NTP server addresses must be set in 0x245A:002 ... 0x245A:005. • The device itself is an NTP client and cannot be used as an NTP server.
	1 EtherCAT Distributed Clocks	If EtherCAT is DC-synchronized and is in the "Safe-Operational" or "Operational" state, the distributed clock is used as the system time. ▶ Synchronisation with "distributed clocks" (DC) 87
	2 Manual input	The system time can be specified manually via parameter 0x245B:002 .
0x245B:002	System time: Current time 0 ... [0] ... 2 ⁶⁴ -1 ns	Specification of the device system time. Store the system time as UTC time. Format: <ul style="list-style-type: none"> • Date MM/DD/YYYY • Time hh:mm:ss.ms
0x245C:001	Local time: Current timezone	Setting of the time zone of the device. The system time and time zone are used to determine the local time of the device.
	0 Unknown time zone	
	2 UTC+4 (GST) Dubai	
	3 UTC+4:30 (AFT) Kabul	
	19 UTC-3 (ART) Buenos Aires	
	37 UTC+11 (AEDT) Melbourne	
	40 UTC+10 (AEST) Brisbane	
	42 UTC+10:30 (ACDT) Adelaide	
	43 UTC+9:30 (ACST) Darwin	
	45 UTC+8:45 (ACWST) Eucla	
51 UTC+6 (BST) Dhaka		

Device settings

Time
NTP server addresses



Address	Name / setting range / [default setting]	Information
	52 UTC+1/+2 (CET/CEST) Brussels	
	84 UTC-3:30 (NST) St. John's	
	102 UTC-7 (MST) Calgary	
	124 UTC+8 (CST) Beijing	
	129 UTC-1 (CVT) Praia	
	145 UTC+2 (EET) Cairo	
	161 UTC+0 (GMT) London	
	177 UTC-2 (GST) King Edward Point	
	187 UTC+7 (WIB) Jakarta	
	194 UTC+5:30 (IST) New Delhi	
	203 UTC+9 (JST) Tokyo	
	209 UTC+14 (LINT) Kiritimati	
	243 UTC+6:30 (MMT) Rangoon	
	278 UTC+5:45 (NPT) Kathmandu	
	280 UTC-11 (NUT) Alofi	
	281 UTC+13 (NZDT) Auckland	
	282 UTC+13:45 (CHADT) Chatham Islands	
	287 UTC-9:30 (MART) Taiohae	
	309 UTC+3 (MSK) Moscow	
	334 UTC+12 (ANAT) Anadyr	
	379 UTC-5 (EST) New York	
	399 UTC-8 (PST) Los Angeles	
	407 UTC-10 (HST) Honolulu	
	410 UTC+5 (UZT) Tashkent	
	413 UTC-4 (VET) Caracas	
0x245C:002	Local time: Current time 0 ... [0] ... 2^64-1 ns	The current local time of the device. Format: <ul style="list-style-type: none"> • Date MM/DD/YYYY • Time hh:mm:ss.ms

7.4.1 NTP server addresses

The Network Time Protocol (NTP) can be used via the network to synchronize the controller time. Selected NTP servers can be specified using IP addresses.

Parameter

Address	Name / setting range / [default setting]	Information
0x245A:002	NTP server addresses: NTP server address 1 0.0.0.0 ... [0.0.0.0] ... 255.255.255.255	Specification of the IP address for one or more Network Time Protocol Servers (NTP). <ul style="list-style-type: none"> • To use NTP, the "NTP" selection must be set in 0x245B:001. • The device itself is an NTP client and cannot be used as an NTP server.
0x245A:003	NTP server addresses: NTP server address 2 0.0.0.0 ... [0.0.0.0] ... 255.255.255.255	
0x245A:004	NTP server addresses: NTP server address 3 0.0.0.0 ... [0.0.0.0] ... 255.255.255.255	
0x245A:005	NTP server addresses: NTP server address 4 0.0.0.0 ... [0.0.0.0] ... 255.255.255.255	



7.5 Device commands

The response of the controller unit can be controlled using device commands that are defined in the parameter objects.

Device commands for the logbook

The controller has a logbook. The events that occur in the controller are saved in the logbook.

▶ [Logbook](#)  148

The following device commands are available to the logbook:

- Delete logbook ▶ [0x2022:015](#)
- Export logbook data ▶ [0x2022:036](#)
- Delete log files ▶ [0x2022:037](#)

Device commands for the application

The application can be reset, started, and stopped.

- Load factory-set default setting of the application ▶ [0x2022:039](#)
- Start program ▶ [0x2022:044](#)
- Stop program ▶ [0x2022:045](#)
- Reset application via a cold start ▶ [0x2022:048](#)
- Application "general reset" ▶ [0x2022:049](#)

Additional device commands

If parameter settings of the controller are changed, then these modifications are applied initially only in the RAM memory of the device. Use the "Save user data" device command to save the parameter settings on the SD card. ▶ [0x2022:003](#)

Use the "Restart device" device command to restart the controller from any state.

▶ [0x2022:035](#)

Use the "Reload boot project" device command to reload the boot project. ▶ [0x2022:046](#)

Use the "Load default settings" device command to reset all the parameters in RAM memory to the factory-set default settings. ▶ [0x2022:001](#)

Parameters (short overview)

The following table shows all the parameters for device commands. The device commands are described in detail in the following subchapters.

Address	Name	Default setting
0x2022:001	Device commands: Load default settings	Off / ready [0]
0x2022:003	Device commands: Save user data	Off / ready [0]
0x2022:015	Device commands: Delete logbook	Off / ready [0]
0x2022:035	Device commands: Restart Device	Off / ready [0]
0x2022:036	Device commands: Export Logbook	Off / ready [0]
0x2022:037	Device commands: Delete Logfiles	Off / ready [0]
0x2022:039	Device commands: Load TA default settings	Off / ready [0]
0x2022:044	Device commands: Start application	Off / ready [0]
0x2022:045	Device commands: Stop application	Off / ready [0]
0x2022:046	Device commands: Reload boot project	Off / ready [0]
0x2022:048	Device commands: Reset Cold	Off / ready [0]
0x2022:049	Device commands: Reset Origin	Off / ready [0]

Device settings

Device commands
Save parameter settings



7.5.1 Save parameter settings

Parameter

Address	Name / setting range / [default setting]	Information
0x2022:003	Device commands: Save user data	The parameter settings are saved on the SD card. <ul style="list-style-type: none"> When the device command has been executed successfully, the value 0 is shown. Do not switch off the supply voltage or remove the SD card from the controller during the storage process! When the controller is switched on, all parameter settings are automatically loaded from the SD card into the RAM memory of the controller.
	0 Off / ready	Only status feedback
	1 On / start	Execute device command
	2 In progress	Only status feedback
	3 Action cancelled	
	4 No access	
	5 No access (Device disabled)	
	101 No SD card connected	
	102 SD card is write protected	
	103 SD card is full	

7.5.2 Reset parameters to default

Parameter

Address	Name / setting range / [default setting]	Information
0x2022:001	Device commands: Load default settings <ul style="list-style-type: none"> Settings can only be changed if the PLC application is not in the "Running" status. 	All parameters in the RAM memory of the controller are reset to the default setting that is stored in the controller firmware as default setting. <ul style="list-style-type: none"> All parameter changes made by the user are lost during this process! When the device command has been executed successfully, the value 0 is shown. Loading parameters has a direct effect on cyclic communication: The data exchange for control is interrupted and a communication error is generated.
	0 Off / ready	Only status feedback
	1 On / start	Execute device command
	2 In progress	Only status feedback
	3 Action cancelled	
	4 No access	
	5 No access (Device disabled)	
0x2022:039	Device commands: Load TA default settings	All controller parameters are reset to the default setting. Parameters that are declared separately in the application are set to the corresponding standard values from the technology application. <ul style="list-style-type: none"> All parameter changes made by the user are lost during this process! When the device command has been executed successfully, the value 0 is shown.
	0 Off / ready	Only status feedback
	1 On / start	Execute device command
	2 In progress	Only status feedback
	3 Action cancelled	
	4 No access	
	5 No access (Device disabled)	



7.5.3 Restart device



When the **Restart device** command is executed, the network connection is lost. If the network setting was not changed, the device can be accessed again after approx. 60 seconds.

Parameter

Address	Name / setting range / [default setting]	Information
0x2022:035	Device commands: Restart Device	
	<ul style="list-style-type: none"> Settings can only be changed if the PLC application is not in the "Running" status. 	
	0 Off / ready	Only status feedback
	1 On / start	Execute device command
	2 In progress	Only status feedback
	3 Action cancelled	
4 No access		
5 No access (Device disabled)		

7.5.4 Start/stop application



Application credit may be required to execute the PLC application.

When the application is compiled, the required application credit is determined.

The value is entered in the following parameters. ▶ [0x2013:002](#)

Insufficient application credit results in the application being executed with a delay.

Please contact your Lenze service center if you require additional application credit.

The PLC application is controlled using the following device commands:

Parameter

Address	Name / setting range / [default setting]	Information
0x2022:044	Device commands: Start application	
	0 Off / ready	Only status feedback
	1 On / start	Execute device command
	2 In progress	Only status feedback
	3 Action cancelled	
	4 No access	
5 No access (Device disabled)		
0x2022:045	Device commands: Stop application	
	0 Off / ready	Only status feedback
	1 On / start	Execute device command
	2 In progress	Only status feedback
	3 Action cancelled	
	4 No access	
5 No access (Device disabled)		

Device settings

Device commands
Load boot project



7.5.5 Load boot project



The reloaded application must be started via the following parameters:

▶ [0x2022:044](#)

This stops a running application!

Parameter

Address	Name / setting range / [default setting]	Information
0x2022:046	Device commands: Reload boot project	
	• Settings can only be changed if the PLC application is not in the "Running" status.	
	0 Off / ready	Only status feedback
	1 On / start	Execute device command
	2 In progress	Only status feedback
	3 Action cancelled	
	4 No access	
5 No access (Device disabled)		

7.5.6 Delete logbook

Parameter

Address	Name / setting range / [default setting]	Information
0x2022:015	Device commands: Delete logbook	All entries in the logbook are deleted.
	0 Off / ready	Only status feedback
	1 On / start	Execute device command
	2 In progress	Only status feedback
	3 Action cancelled	
	4 No access	
	5 No access (Device disabled)	

▶ [Logbook](#) 148

7.5.7 Export logbook

Parameter

Address	Name / setting range / [default setting]	Information
0x2022:036	Device commands: Export Logbook	Exports the logbook for the upload into the engineering tools.
	0 Off / ready	Only status feedback
	1 On / start	Execute device command
	2 In progress	Only status feedback
	3 Action cancelled	
	4 No access	
	5 No access (Device disabled)	

▶ [Logbook](#) 148



7.5.8 Delete log files

Parameter

Address	Name / setting range / [default setting]	Information
0x2022:037	Device commands: Delete Logfiles	Deletion of log files on the device that were exported in an earlier step via 0x2022:036 (Export Logbook).
	0 Off / ready	Only status feedback
	1 On / start	Execute device command
	2 In progress	Only status feedback
	3 Action cancelled	
	4 No access	
	5 No access (Device disabled)	

▶ [Logbook](#) 148

7.5.9 Reset cold

The "Cold reset" command causes a cold start of the application active in the controller.

Precondition: The application is in online operation.

- The cold reset initializes the parameters to the Lenze setting. The previous parameter values are lost.
- The cold reset initializes the retain variables. The previous values are lost.
- The cold reset initializes the persistent variables. The previous values are retained.

Parameter

Address	Name / setting range / [default setting]	Information
0x2022:048	Device commands: Reset Cold	
	0 Off / ready	Only status feedback
	1 On / start	Execute device command
	2 In progress	Only status feedback
	3 Action cancelled	
	4 No access	
	5 No access (Device disabled)	

7.5.10 Reset origin

The "Reset origin" command causes the active application in the controller to be deleted ("general reset").

Precondition: The application is in online operation.

- Reset origin deletes all parameters.
- Reset origin deletes all retain variables.
- Reset origin deletes all persistent variables.

Parameter

Address	Name / setting range / [default setting]	Information
0x2022:049	Device commands: Reset Origin	
	0 Off / ready	Only status feedback
	1 On / start	Execute device command
	2 In progress	Only status feedback
	3 Action cancelled	
	4 No access	
	5 No access (Device disabled)	



7.6 Firmware update mode for field devices

The "Field device firmware update" parameter is used to define whether and under which conditions the firmware is automatically updated after the firmware versions have been compared.

This function applies to inverters that support firmware download, e.g. frequency inverter i550 cabinet.

The firmware and the settings of the inverter parameters are saved together with the "PLC Designer" project.

During start-up, the Lenze Controller checks whether the firmware version and the parameter settings of the inverter match the data stored in the project for this device.



When comparing the firmware versions, pay particular attention to the major version. The firmware consists of four groups of 2 digits each. The groups are separated by periods. The first group indicates the major version, e.g. 06.xx.xx.xx



Parameter

Address	Name / setting range / [default setting]	Information
0x5820:001	Field devices: Firmware update	
	0 Disabled	<p>The firmware update is deactivated.</p> <p>The controller does not perform a firmware download, but immediately starts the parameter set download to the inverter (EtherCAT slave). When the parameter set download has been successfully completed, the controller sets the EtherCAT bus to OPERATIONAL state.</p> <p>This setting can be used if devices with an older firmware version are attached to the EtherCAT.</p>
	1 Enabled. Slave FW = config. FW	<p>A firmware update is performed when the firmware of the inverter has the following version:</p> <ul style="list-style-type: none"> identical major version different firmware <p>Example: Inverter: 06.01.xx.xx, PLC project / controller: 06.02.xx.xx</p> <p>After the firmware download, the parameter set download to the inverter (EtherCAT slave) starts. When the parameter set download has been successfully completed, the controller sets the EtherCAT bus to OPERATIONAL state.</p> <p>If the major version is not the same, no firmware update is performed. The EtherCAT bus remains in the PRE-OPERATIONAL state.</p>
	2 Enabled. Slave FW > config. FW	<p>Four cases must be considered in this setting:</p> <ul style="list-style-type: none"> Case 1: The firmware of the inverter is identical to the firmware archived in the controller. <ul style="list-style-type: none"> No firmware download is performed. After the firmware download, the parameter set download to the inverter (EtherCAT slave) starts. When the parameter set download has been successfully completed, the controller sets the EtherCAT bus to OPERATIONAL state. Case 2: The major version of the inverter firmware is greater than the major version of the firmware archived in the controller. <ul style="list-style-type: none"> No firmware download is performed. The controller starts the parameter set download to the inverter (EtherCAT slave). When the parameter set download has been successfully completed, the controller sets the EtherCAT bus to OPERATIONAL state. Case 3: The major version of the inverter firmware is the same as the major version of the firmware archived in the controller. <ul style="list-style-type: none"> A firmware download is performed. After the firmware download, the parameter set download to the inverter (EtherCAT slave) starts. When the parameter set download has been successfully completed, the controller sets the EtherCAT bus to OPERATIONAL state. Case 4: The major version of the inverter firmware is less than the major version of the firmware archived in the controller. <ul style="list-style-type: none"> No firmware download is performed. No parameter set download is performed. The EtherCAT bus remains in the PRE-OPERATIONAL state.

Please note that even in case of a failed parameter set download, the EtherCAT bus does not leave the PRE-OPERATIONAL state.

If the cause preventing the state transition to OPERATIONAL has been eliminated (e.g. by replacing the inverter or updating the parameter set), the network must be restarted.

Learn how to restart the network in chapter [Restart network](#) 74.



8 Configure engineering port

The engineering port **X16** is used to commission and diagnose the controller with an engineering PC.



By default, the IP address **192.168.5.99** is preset for the engineering port to enable fast commissioning.



Changed engineering port settings are retained after a restart of the controller. If there is an active connection, changing and activating the engineering port settings will abort the communication with the controller.



8.1 Automatic configuration via parameters

In the "as delivered" condition, the IP address is non-adjustable. However, the IP settings can also be specified via a DHCP server.



When using DHCP, changing the IP address may also lead to the network name being changed. ▶ [Device name](#) 46

Therefore, DHCP should only be used if there is a local name server in the network and the network name is not used for the gateway function.

Parameter

Address	Name / setting range / [default setting]	Information
0x2451:004	Engineering port settings: DHCP	Use (enable) of the Dynamic Host Configuration Protocol (DHCP).
	0 Disabled	
	1 Enabled	



8.2 Manual configuration via parameters

The engineering port must be configured manually via parameters when a static IP address is to be assigned.



Please note that a "Restart with current values" must be carried out after each address change for the new setting to take effect. ▶ [0x2450](#)

The configuration is only saved persistently in the parameter set by the "Save user data" device command or by creating a boot project. ▶ [0x2022:003](#)

Preconditions

DHCP must be set to "Blocked". ▶ [0x2451:004](#)

Parameter

Address	Name / setting range / [default setting]	Information
0x2451:001	Engineering port settings: IP address 0.0.0.0 ... [0.0.0.0] ... 255.255.255.255	Setting of the IP address. The default setting 1661315264 corresponds to the following values: <ul style="list-style-type: none">• 1661315264• 0x6305A8C0• 0xC0.0xA8.0x05.0x63• 192.168.5.99
0x2451:002	Engineering port settings: Subnet 0.0.0.0 ... [0.0.0.0] ... 255.255.255.255	Setting of the subnet mask.
0x2451:003	Engineering port settings: Gateway 0.0.0.0 ... [0.0.0.0] ... 255.255.255.255	Setting of the gateway address.



8.3 Configuration via file

A file named "ip.txt" can be used to set the IP address directly. This file must be stored on the SD card in the root directory. The file can be created and copied on a Windows PC.

The network settings are evaluated and accepted when the controller is booting. This transfers the IP settings to the parameter setting of the controller automatically; these settings are persistent. The file is then renamed "ip_old.txt". It is possible to change the IP addressing at any time if the file is available again as "ip.txt".

The "ip.txt" file must have the following structure:

IP address
Subnet mask
Gateway address

Example:

192.168.101.221
255.255.255.0
192.168.101.1

If the static IP address is to be reset to DHCP, only the contents of the "ip.txt" file must be set to "DHCP". This serves to use DHCP for a dynamic address allocation at next boot.



8.4 Perform restart with current settings

The engineering tool can use this parameter to restart the device in order to adopt the current settings for the engineering port.

Parameter

Address	Name / setting range / [default setting]	Information
0x2450	Engineering port control	Acceptance of the current settings (0x2451:xxx) for the engineering port.
	0 No action/No error	Only status feedback
	1 Restart with current values	Restart the device to apply the current settings.
	10 Busy	Only status feedback
	11 Action cancelled	
12 Faulted		



8.5 Diagnostics

8.5.1 Active engineering port settings

The following parameters show the currently active settings of the engineering port.



Parameter

Address	Name / setting range / [default setting]	Information	
0x2452:001	Active engineering port settings: IP address • Read only	Display of the active IP address.	
0x2452:002	Active engineering port settings: Subnet • Read only	Display of the active subnet mask.	
0x2452:003	Active engineering port settings: Gateway • Read only	Display of the active gateway address.	
0x2452:004	Active engineering port settings: DHCP • Read only	Display of the DHCP status.	
	0 Disabled		
	1 Enabled		
0x2452:005	Active engineering port settings: MAC address • Read only	Display of the MAC-ID.	



9 Configuring the network

This chapter contains information on configuring the network:

- ▶ [EtherCAT master](#)  65
- ▶ [EtherCAT slave](#)  98
- ▶ [PROFINET IO-Device](#)  106



9.1 EtherCAT master

Chapter overview

- ▶ EtherCAT state machine [66](#)
- ▶ Addressing of the slaves [68](#)
- ▶ Commissioning [69](#)
- ▶ Determine the physical EtherCAT configuration (network scan) [70](#)
- ▶ Edit EtherCAT I/O mapping [73](#)
- ▶ Restart network [74](#)
- ▶ Parameter data transfer [75](#)
- ▶ Diagnostics [75](#)
- ▶ Advanced configuration [86](#)
- ▶ Error scenarios [83](#)
- ▶ Modular machine configuration [91](#)



EtherCAT® (Ethernet for Controller and Automation Technology) is an Ethernet-based fieldbus system which fulfils the application profile for industrial realtime systems.

- EtherCAT® is a registered trademark and patented technology, licensed by Beckhoff Automation GmbH, Germany.
- Detailed information on EtherCAT can be found on the web page of EtherCAT Technology Group (ETG): <http://www.ethercat.org>

Preconditions

- For commissioning, load the current device description files for the EtherCAT devices onto your engineering PC via the »Package Manager«.
- For EtherCAT devices from other manufacturers, the device description must be imported accordingly from the homepage of the manufacturer.

Typical topology

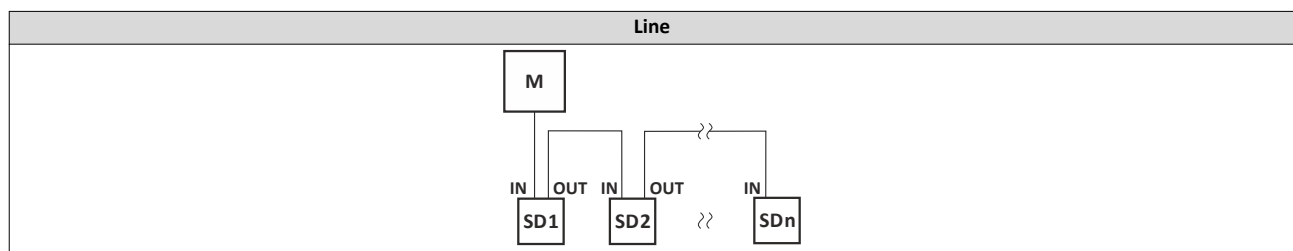

M Master
SD Slave device



9.1.1 EtherCAT state machine

Before communication via EtherCAT is possible, the fieldbus scans the EtherCAT state machine when booting. The following illustration shows the possible state change from the point of view of an EtherCAT slave:

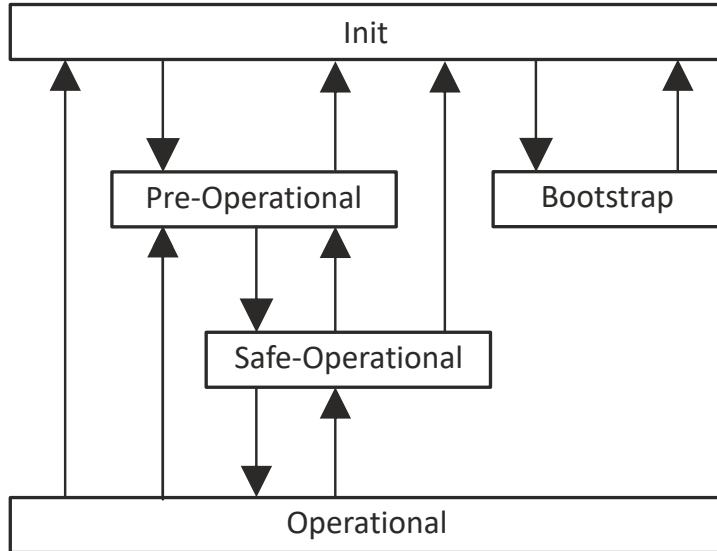

Fig. 2: EtherCAT state machine

State	Description
Init	<ul style="list-style-type: none"> Initialization phase No SDO/PDO communication with the slaves Device can be detected by fieldbus scan
Pre-operational	<ul style="list-style-type: none"> The fieldbus is active. SDO communication (mailbox communication) is possible. No PDO communication
Safe-operational	<ul style="list-style-type: none"> SDO communication (mailbox communication) is possible. PDO communication: <ul style="list-style-type: none"> The input data in the process image is updated. The output data from the process image is not transferred to the slaves.
Operational	Normal operation <ul style="list-style-type: none"> SDO communication PDO communication Fieldbus synchronization has been successful (if used)



A fieldbus scan is possible in any EtherCAT state.

The SDO communication via the EtherCAT bus is only possible if at least the "Pre-Operational" state has been reached.



AL status code

Possible errors during transitions between states are entered in the EtherCAT register of the concerned slave in **AL Status Code** (address 0x0134:0x0135).

Often indicated AL status code [hex]	Description
0x0000	No error
0x0011	Invalid status change requested
0x0012	Unknown status requested
0x0013	Bootstrap status is not supported
0x0016	Invalid mailbox configuration Pre-Operational
0x001A	Synchronization error
0x001B	Sync manager watchdog
0x001D	Invalid output data configuration
0x001E	Invalid input data configuration
0x002B	Invalid input and output data
0x0030	Invalid configuration of DC synchronization
0x9001	Firmware watchdog error
0x9002	Mapping error



9.1.2 Addressing of the slaves

The EtherCAT system uses two types of addressing for the slaves:

1. Auto-increment addressing
2. Fixed-address addressing

Auto-increment addressing

Auto-increment addressing is used by the master during the initialization phase of the fieldbus. When the **Pre-Operational** state has been reached, the master uses fixed-address addressing.

Synchronizing the internal EtherCAT slave



The controller contains an internal EtherCAT slave with its own address to provide the synchronization.

Thus, the connected first nodes have the following start address:

- **0xFFFE** by the auto-increment procedure
- **1002** by fixed-address addressing

The additional internal slave is also to be taken into consideration when running network diagnostics.

Fixed-address addressing

With the fixed-address addressing, the slaves are addressed via the station address distributed by the master during the start-up phase. In the EtherCAT bus topology in the »PLC Designer«, the first slave is given the address **1001**, the second slave the address **1002** and so on. The EtherCAT addresses cannot be changed. The EtherCAT address of the master is **0**. Access to master objects with the address **0** is possible.

Example of the auto-increment procedure and fixed-address addressing

The first slave of a configuration is an **internal** slave and is given the following address:

- Auto-increment procedure: **0**
- Fixed-address addressing procedure: **1001**

The first **external** slave of a configuration is given the following addresses:

- Auto-increment procedure: **-1**
- Fixed-address addressing procedure: **1002**



The auto-increment procedure uses negative numbering.



9.1.3 Commissioning

The EtherCAT master enables the control of the subordinate EtherCAT device. Connected EtherCAT slaves can be configured in this way using the engineering PC.

Preconditions

- The field devices are installed as per the information in the device-specific mounting instructions.
- The commissioning of the controller is completed.

Recommended sequence of the commissioning steps

1. Use the **Online Login** menu command or the **<Alt> + <F11>** keys to log into the controller.
2. ▶ [Determine the physical EtherCAT configuration \(network scan\)](#) [70](#)
3. Adapt the network configuration.
4. ▶ [Edit EtherCAT I/O mapping](#) [73](#)
5. Use the **Build Compile** menu command or the **<F11>** function key to compile the program code.
6. Use the **Online Login** menu command or the **<Alt> + <F11>** keys to load the configuration.
7. Use the **Debug Start** menu command or the **<F5>** function key to start the PLC program.

Configuring the network

EtherCAT master

Determine the physical EtherCAT configuration (network scan)



9.1.4 Determine the physical EtherCAT configuration (network scan)

In order to check the physical EtherCAT configuration, you can use the »PLC Designer« to carry out a network scan on the controller online.

How to carry out a network scan:

1. Execute the "Start Search" command in the context menu of the master.
The appearing dialog box lists all available EtherCAT devices according to the physical order in the network.
2. Click on the button "Copy all devices into the project".

The physical network structure is reproduced in the »PLC Designer« project.



A proper operation requires that the network topology generated in the project corresponds to the physical order of the EtherCAT devices in the network. Otherwise, an error message displays which slave (vendor ID/product code) is to be expected at which position.

The master automatically assigns the station addresses to the slaves. Therefore, a manual address assignment is not required.



Configuring the network

EtherCAT master

Determine the physical EtherCAT configuration (network scan)

How to determine the physical EtherCAT configuration:

Precondition

- Configuring the communication parameters
- Log in to the controller

1. Select the **Start Search** command in the context menu of the EtherCAT master.

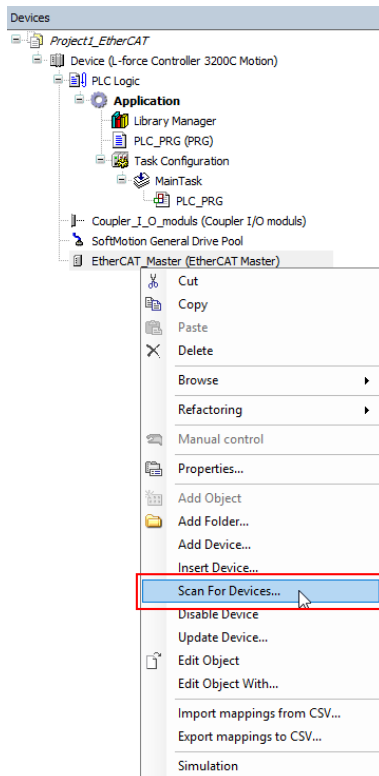

A dialog opens.

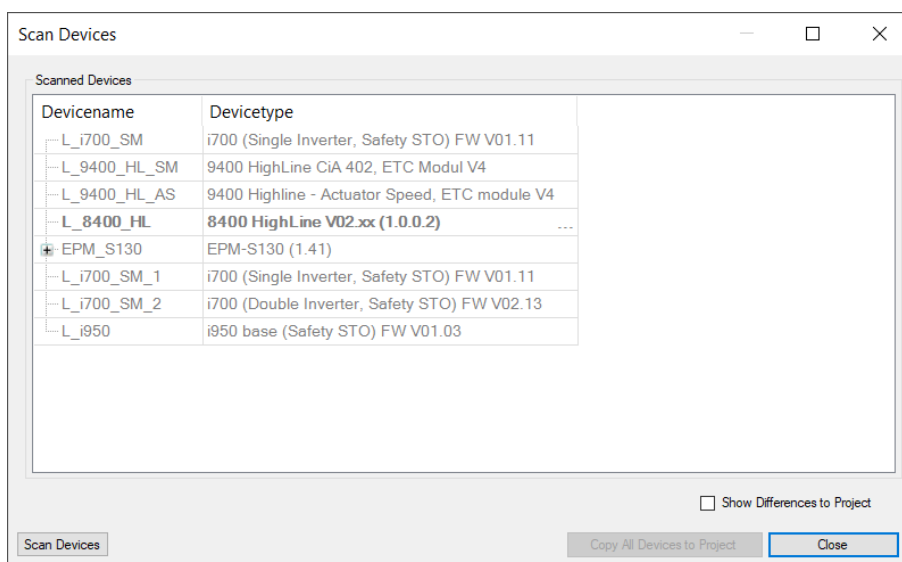

2. Click the **Copy all devices** button to copy them to the PLC project or select individual devices and copy them to the PLC project.

3. Select the **Show differences to project** checkbox.

The devices found and the devices configured are compared.

Configuring the network

EtherCAT master

Determine the physical EtherCAT configuration (network scan)

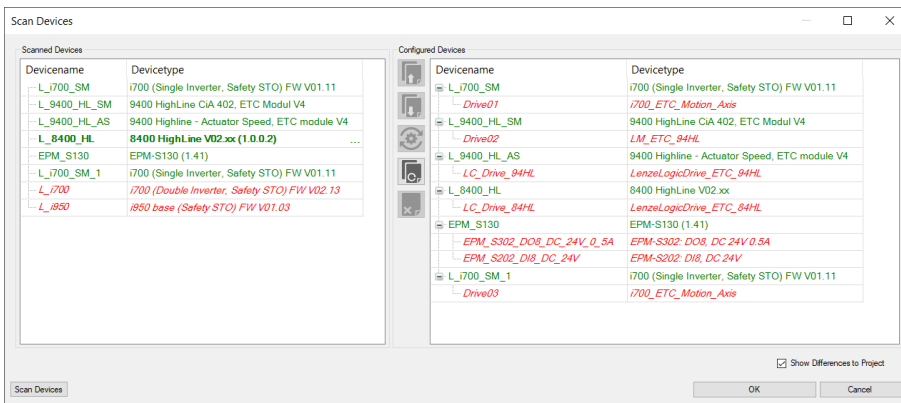

4. Adapting the configuration:

- a) Click the **Copy all** button to copy all devices into the project.
- b) Copy individual devices into the project.

The devices are added to the project.



If a device is not available on the EtherCAT, an error message indicates this.



When using the S130 EtherCAT bus coupler, the connected IO-1000 discs are only detected in the **Pre-Operational** state. Therefore, the scan (Search device) must be performed twice.



9.1.5 Edit EtherCAT I/O mapping



If you insert additional field devices in the control configuration or change the PDO mapping, the object addresses change. Therefore, the input and output objects in the PLC program must be accessed via individual unambiguous variables. The variable names must comply with the IEC 61131 syntax.



The manual assignment of object addresses in the Address column is not supported.

On the **EtherCAT I/O image** tab, you can enter variable names by double-clicking the variable fields or pressing the space key. By clicking the menu button, you can reference already existing variables or enter variable names directly in the input field to create system variables. For the PLC program, the corresponding system variables are available.

9.1.5.1 Set PDO mapping

Set the PDO mapping in the selected EtherCAT slave. The process data serves to select the inputs and outputs.

The PDO mapping for the EtherCAT slave can be composed of 3 parts:

- Unchangeable static part.
- Dynamic part. Contains PDOs for the different operation modes.
- Freely configurable part. Activated in the »PLC Designer« and enables individual mapping.

Changing PDO mapping settings

Index	Size	Name	Flags	SM
16#1900	27.0	Aes Ai: csp	F	2
16#1901	17.0	Aes Ai: csp	F	
16#1902	11.0	Aes Ai: csv	F	
16#1903	7.0	Aes Ai: vl	F	
16#1904	2.0	Aes Ai: TP	F	2
16#1905	0.0	Aes Ai: Free configuration	F	
16#1906	4.0	Aes Ai: Torque limits	F	2
16#1907	8.0	Aes Ai: Speed limits	F	2
16#1908	21.0	Aes Ai: csp	F	3
16#1A01	13.0	Aes Ai: csp	F	
16#1A02	17.0	Aes Ai: csv	F	
16#1A03	9.0	Aes Ai: vl	F	
16#1A04	18.0	Aes Ai: TP	F	3
16#1A05	0.0	Aes Ai: Free configuration	F	
16#1A06	6.0	Aes Ai: Additional status information	F	3

Index	Size	OPs	Name	Type
16#4000:00	2.0	4.0	Control word	UNNT
16#2030:00	2.0	2.0	Lenze control word	UNNT
16#060:00	1.0	4.0	Modes of operation	SNNT
16#080:00	2.0	5.0	Torque offset	INT
16#070:00	4.0	7.0	Target position	DINT
16#0B1:00	4.0	11.0	Velocity offset	DINT
16#2002:00	2.0	15.0	Speed controller: I component load val	INT
			17.0	

How to change the PDO mapping settings:

1. Activate expert settings in the »PLC Designer«
2. Remove the checkmark in the PDO assignment checkbox.
3. Check the desired setting.

The setting has been changed.

9.1.5.2 Activate PDO mapping

If the device descriptions for corresponding EtherCAT devices that are supplied with the »PLC Designer« are used, the process data is copied to the subordinate node automatically.

Manually link process data

If the process data is still to be linked manually, activate the **Direct access to I/O addresses by the application** option on the **LenzeLogicDrive Configuration** tab. In this setting, you cannot use the prepared function blocks. The process data (I/O addresses) must be linked manually.

Configuring the network

EtherCAT master
Restart network



9.1.6 Restart network

The EtherCAT master communication is restarted automatically if a new configuration is loaded on the controller.

These are the options for restarting the communication:

1. Request restart of the EtherCAT master.
 - Commands for EtherCAT master system bus. ▶ [0x5850:001](#)
 - Via a function block that is added to the EtherCAT master in the project. Via the function block input xRestart (positive edge), the EtherCAT slaves are started up after **INIT** and again after **Operational**.
2. Switch controller off and on again.



The EtherCAT configuration is part of the PLC program. If the changes are to remain even after the voltage switching of the controller, the boot project must be recreated.

Parameter

Address	Name / setting range / [default setting]	Information
0x2360	EtherCAT communication	Restart communication. <ul style="list-style-type: none"> • When the device command has been executed successfully, the value 0 is shown.
	0 No action/no error	Only status feedback
	1 Restart with current values	Execute command
	2 Restart with default values	
	5 Stop network communication	
	10 In process	Only status feedback
	11 Action cancelled	
	12 Fault	
0x5850:001	EtherCAT master commands: Kommunikation neu starten	Restart of the EtherCAT master. <ul style="list-style-type: none"> • The current configuration becomes active. • The EtherCAT communication is restarted.
	0 No action/no error	Only status feedback
	1 Neustart	Execute command Execute command
	10 Busy	Only status feedback
	11 Action cancelled	
	12 Faulted	
0x5850:002	EtherCAT master commands: Reset counters	
	0 No action/no error	Only status feedback
	1 Reset master counters	Execute command
	2 Reset slave counters	
	3 Reset all counters	
	10 Busy	Only status feedback
	11 Action cancelled	
12 Faulted		



9.1.7 Parameter data transfer

For configuring and diagnosing the EtherCAT devices, the parameters are accessed by means of acyclic communication.

- Parameter data is transferred as SDOs (Service Data Objects) .
- The SDO services enable write and read access to parameters, EtherCAT objects and profile-specific objects.
- The transfer of parameter data is usually not time-critical.
- Parameter data is, for instance, operating parameters, motor data and diagnostic information.

SDOs are read and written internally automatically via the EtherCAT master. SDO access is also possible via the function blocks of the PLC program.

9.1.8 Diagnostics

9.1.8.1 EtherCAT master diagnostics

Information is only displayed in the parameter list under **Diagnostic Master** if an online connection to the master has been established.

The following information is displayed:

- Most recent error
- Number of emergency frames
- Status information
- Information on the network topology
- Frame and error counter

In addition to the EtherCAT states, additional diagnostic information of up to 4 selected EtherCAT slaves is displayed under **Diagnostic Slaves**.

The following information is displayed:

- Slave information
- Addresses
- State
- Count values
- DC sync times

The EtherCAT slave address can be specified using the following parameters:

- ▶ [0x585C:001](#)
- ▶ [0x585D:001](#)
- ▶ [0x585E:001](#)
- ▶ [0x585F:001](#)

Parameter

Address	Name / setting range / [default setting]	Information
0x5851:001	EtherCAT master diagnosis: EtherCAT master state <ul style="list-style-type: none"> • Read only 	Display of the EtherCAT master state.
	0 Unknown	
	1 Init	
	2 Pre-Operational	
	3 Bootstrap	
	4 Safe-Operational	
	8 Operational	

Configuring the network

EtherCAT master
Diagnostics
EtherCAT master diagnostics



Address	Name / setting range / [default setting]	Information
0x5851:002	EtherCAT master diagnosis: EtherCAT master state summary • Read only	Display of the EtherCAT master state overview.
	Bit 0 Master OK	
	Bit 3 Reserved	
	Bit 4 Init	
	Bit 5 Pre-Operational	
	Bit 6 Safe-Operational	
	Bit 7 Operational	
	Bit 8 Slaves in requested state	
	Bit 9 Master in requested state	
	Bit 10 Bus scan match	
	Bit 12 DC enabled	
	Bit 13 DC in sync	
	Bit 14 DC busy	
	Bit 16 Link up	
0x5851:003	EtherCAT master diagnosis: EtherCAT error • Read only	Display whether an EtherCAT network error has occurred.
0x5851:004	EtherCAT master diagnosis: Bus scan match • Read only	Display whether a "Bus Scan Match" exists.
	0 Mismatch	
	1 Match	
0x5851:005	EtherCAT master diagnosis: Configured cycle time • Read only: x μ s	
0x5851:006	EtherCAT master diagnosis: Connected slaves • Read only	Display of the number of slaves available in the network.
0x5851:007	EtherCAT master diagnosis: Configured slaves • Read only	Display of the number of configured slaves.
0x5851:008	EtherCAT master diagnosis: TX frame counter • Read only	Displayed information corresponds to the values from the EtherCAT register content.
0x5851:009	EtherCAT master diagnosis: Lost frame counter • Read only	
0x5851:010	EtherCAT master diagnosis: Working counter error • Read only	
0x5851:011	EtherCAT master diagnosis: DC slave sync deviation limit • Read only	
0x5851:012	EtherCAT master diagnosis: DC current deviation • Read only	



Configuring the network

EtherCAT master
Diagnostics
EtherCAT master diagnostics

Address	Name / setting range / [default setting]	Information
0x5851:013	EtherCAT master diagnosis: Master mode • Read only	
	0 None	
	1 Normal	
	100 Modular machine configuration	
	200 SuperSetENI	
0x5851:014	EtherCAT master diagnosis: Slave state summary • Read only	
	Bit 0 Initialization	
	Bit 1 Pre-Operational	
	Bit 2 Safe-Operational	
	Bit 3 Operational	
	Bit 4 Fehler	
	Bit 5 Bootstrap	
0x5851:015	EtherCAT master diagnosis: State machine • Read only	
	0 None	
	1 Configuration	
	2 Initialized	
	10 Pre-Operational	
	20 Download service	
	21 Firmware download	
	22 Firmware reload	
	30 Operational	
	100 Adress assignment	
	65519 Unkonwn	
0x5851:030	EtherCAT master diagnosis: Connection error level • Read only	
0x5851:031	EtherCAT master diagnosis: Error counter threshold for logging 0 ... [100] ... 255	
0x5851:032	EtherCAT master diagnosis: RX error counter • Read only	
0x5851:033	EtherCAT master diagnosis: Processing unit error counter • Read only	
0x5851:034	EtherCAT master diagnosis: PDI error counter • Read only	
0x5851:035	EtherCAT master diagnosis: Lost link counter • Read only	
0x585C:001	EtherCAT master slave information: Slave address -2147483648 ... [0] ... 2147483647	Specification of the slave address to be diagnosed. The first slave is an internal slave; therefore, the first external slave must receive the address 1002, the second slave must receive the address 1003, etc. This also applies to the auto increment procedure. The address of the first external slave is the -2, the second address is the -3, etc.
0x585C:002	EtherCAT master slave information: Vendor ID • Read only	Displayed information corresponds to the values from the EtherCAT register content.
0x585C:003	EtherCAT master slave information: Product code • Read only	
0x585C:004	EtherCAT master slave information: Revision • Read only	
0x585C:005	EtherCAT master slave information: Serial number • Read only	
0x585C:006	EtherCAT master slave information: Auto-increment address • Read only	

Configuring the network

EtherCAT master
Diagnostics
EtherCAT master diagnostics



Address	Name / setting range / [default setting]	Information
0x585C:007	EtherCAT master slave information: Fixed address • Read only	
0x585C:008	EtherCAT master slave information: Second station address • Read only	
0x585C:010	EtherCAT master slave information: Master data link status • Read only	
	Bit 0	EEPROM loaded correctly and PDI operational
	Bit 1	PDI watchdog status (reloaded)
	Bit 2	Enhanced link detection
	Bit 4	Physical link on port 0
	Bit 5	Physical link on port 1
	Bit 6	Physical link on port 2
	Bit 7	Physical link on port 3
	Bit 8	Loop port 0 (closed)
	Bit 9	Communication on port 0 (stable)
	Bit 10	Loop port 1 (closed)
	Bit 11	Communication on port 1 (stable)
	Bit 12	Loop port 2 (closed)
	Bit 13	Communication on port 2 (stable)
	Bit 14	Loop port 3 (closed)
	Bit 15	Communication on port 3 (stable)
0x585C:011	EtherCAT master slave information: Master AL Status • Read only	
	Bit 0	Init
	Bit 1	Pre-Operational
	Bit 2	Safe-Operational
	Bit 3	Operational
0x585C:012	EtherCAT master slave information: Master AL Status • Read only	
	Bit 4	Error Ind
	0x585C:012 EtherCAT master slave information: Master RX Error Counter (Port 0-3) • Read only	
	0x585C:013 EtherCAT master slave information: Master Forwarded RX Error Counter (Port 0-3) • Read only	
	0x585C:014 EtherCAT master slave information: Master Processing Unit Error Counter • Read only	
0x585C:015 EtherCAT master slave information: Master PDI Error Counter • Read only		
0x585C:016 EtherCAT master slave information: Master Lost Link Counter (Port 0-3) • Read only		
0x585C:017 EtherCAT master slave information: Master DC Sync 0 Period • Read only		
0x585C:018 EtherCAT master slave information: Master DC Sync 1 Period • Read only		
0x585D:001	EtherCAT master slave information: Master - Slave Address (AutoInc or Fixed) -2147483648 ... [0] ... 2147483647	Specification of the slave address to be diagnosed. The first slave is an internal slave; therefore, the first external slave must receive the address 1002, the second slave must receive the address 1003, etc. This also applies to the auto increment procedure. The address of the first external slave is the -2, the second address is the -3, etc.



Configuring the network

EtherCAT master
Diagnostics
EtherCAT master diagnostics

Address	Name / setting range / [default setting]	Information
0x585D:002	EtherCAT master slave information: Master VendorID • Read only	Displayed information corresponds to the values from the EtherCAT register content.
0x585D:003	EtherCAT master slave information: Master Product code • Read only	
0x585D:004	EtherCAT master slave information: Master Revision • Read only	
0x585D:005	EtherCAT master slave information: Master Serial number • Read only	
0x585D:006	EtherCAT master slave information: Master Auto-increment address • Read only	
0x585D:007	EtherCAT master slave information: Master Fixed address • Read only	
0x585D:008	EtherCAT master slave information: Master Second station address • Read only	
0x585D:010	EtherCAT master slave information: Master data link status • Read only	
	Bit 0	EEPROM loaded correctly and PDI operational
	Bit 1	PDI watchdog status (reloaded)
	Bit 2	Enhanced link detection
	Bit 4	Physical link on port 0
	Bit 5	Physical link on port 1
	Bit 6	Physical link on port 2
	Bit 7	Physical link on port 3
	Bit 8	Loop port 0 (closed)
	Bit 9	Communication on port 0 (stable)
	Bit 10	Loop port 1 (closed)
	Bit 11	Communication on port 1 (stable)
	Bit 12	Loop port 2 (closed)
	Bit 13	Communication on port 2 (stable)
	Bit 14	Loop port 3 (closed)
	Bit 15	Communication on port 3 (stable)
0x585D:011	EtherCAT master slave information: Master AL Status • Read only	
	Bit 0	Init
	Bit 1	Pre-Operational
	Bit 2	Safe-Operational
	Bit 3	Operational
Bit 4	Error Ind	
0x585D:012	EtherCAT master slave information: Master RX Error Counter (Port 0-3) • Read only	
0x585D:013	EtherCAT master slave information: Master Forwarded RX Error Counter (Port 0-3) • Read only	
0x585D:014	EtherCAT master slave information: Master Processing Unit Error Counter • Read only	
0x585D:015	EtherCAT master slave information: Master PDI Error Counter • Read only	

Configuring the network

EtherCAT master
Diagnostics
EtherCAT master diagnostics



Address	Name / setting range / [default setting]	Information	
0x585D:016	EtherCAT master slave information: Master Lost Link Counter (Port 0-3) • Read only		
0x585D:017	EtherCAT master slave information: Master DC Sync 0 Period • Read only		
0x585D:018	EtherCAT master slave information: Master DC Sync 1 Period • Read only		
0x585E:001	EtherCAT master slave information: Master - Slave Address (AutoInc or Fixed) -2147483648 ... [0] ... 2147483647	Specification of the slave address to be diagnosed. The first slave is an internal slave; therefore, the first external slave must receive the address 1002, the second slave must receive the address 1003, etc. This also applies to the auto increment procedure. The address of the first external slave is the -2, the second address is the -3, etc.	
0x585E:002	EtherCAT master slave information: Master VendorID • Read only	Displayed information corresponds to the values from the EtherCAT register content.	
0x585E:003	EtherCAT master slave information: Master Product code • Read only		
0x585E:004	EtherCAT master slave information: Master Revision • Read only		
0x585E:005	EtherCAT master slave information: Master Serial number • Read only		
0x585E:006	EtherCAT master slave information: Master Auto-increment address • Read only		
0x585E:007	EtherCAT master slave information: Master Fixed address • Read only		
0x585E:008	EtherCAT master slave information: Master Second station address • Read only		
0x585E:010	EtherCAT master slave information: Master data link status • Read only		
	Bit 0		EEPROM loaded correctly and PDI operational
	Bit 1		PDI watchdog status (reloaded)
	Bit 2	Enhanced link detection	
	Bit 4	Physical link on port 0	
	Bit 5	Physical link on port 1	
	Bit 6	Physical link on port 2	
	Bit 7	Physical link on port 3	
	Bit 8	Loop port 0 (closed)	
	Bit 9	Communication on port 0 (stable)	
	Bit 10	Loop port 1 (closed)	
	Bit 11	Communication on port 1 (stable)	
	Bit 12	Loop port 2 (closed)	
	Bit 13	Communication on port 2 (stable)	
	Bit 14	Loop port 3 (closed)	
	Bit 15	Communication on port 3 (stable)	



Configuring the network

EtherCAT master
Diagnostics
EtherCAT master diagnostics

Address	Name / setting range / [default setting]	Information
0x585E:011	EtherCAT master slave information: Master AL Status	
	• Read only	
	Bit 0 Init	
	Bit 1 Pre-Operational	
	Bit 2 Safe-Operational	
	Bit 3 Operational	
0x585E:012	EtherCAT master slave information: Master RX Error Counter (Port 0-3)	
• Read only		
0x585E:013	EtherCAT master slave information: Master Forwarded RX Error Counter (Port 0-3)	
• Read only		
0x585E:014	EtherCAT master slave information: Master Processing Unit Error Counter	
• Read only		
0x585E:015	EtherCAT master slave information: Master PDI Error Counter	
• Read only		
0x585E:016	EtherCAT master slave information: Master Lost Link Counter (Port 0-3)	
• Read only		
0x585E:017	EtherCAT master slave information: Master DC Sync 0 Period	
• Read only		
0x585E:018	EtherCAT master slave information: Master DC Sync 1 Period	
• Read only		
0x585F:001	EtherCAT master slave information: Master - Slave Address (AutoInc or Fixed) -2147483648 ... [0] ... 2147483647	Specification of the slave address to be diagnosed. The first slave is an internal slave; therefore, the first external slave must receive the address 1002, the second slave must receive the address 1003, etc. This also applies to the auto increment procedure. The address of the first external slave is the -2, the second address is the -3, etc.
0x585F:002	EtherCAT master slave information: Master VendorID	Displayed information corresponds to the values from the EtherCAT register content.
• Read only		
0x585F:003	EtherCAT master slave information: Master Product code	
• Read only		
0x585F:004	EtherCAT master slave information: Master Revision	
• Read only		
0x585F:005	EtherCAT master slave information: Master Serial number	
• Read only		
0x585F:006	EtherCAT master slave information: Master Auto-increment address	
• Read only		
0x585F:007	EtherCAT master slave information: Master Fixed address	
• Read only		
0x585F:008	EtherCAT master slave information: Master Second station address	
• Read only		

Configuring the network

EtherCAT master
Diagnostics
EtherCAT master diagnostics



Address	Name / setting range / [default setting]	Information
0x585F:010	EtherCAT master slave information: Master data link status • Read only	
	Bit 0 EEPROM loaded correctly and PDI operational	
	Bit 1 PDI watchdog status (reloaded)	
	Bit 2 Enhanced link detection	
	Bit 4 Physical link on port 0	
	Bit 5 Physical link on port 1	
	Bit 6 Physical link on port 2	
	Bit 7 Physical link on port 3	
	Bit 8 Loop port 0 (closed)	
	Bit 9 Communication on port 0 (stable)	
	Bit 10 Loop port 1 (closed)	
	Bit 11 Communication on port 1 (stable)	
	Bit 12 Loop port 2 (closed)	
	Bit 13 Communication on port 2 (stable)	
	Bit 14 Loop port 3 (closed)	
	Bit 15 Communication on port 3 (stable)	
0x585F:011	EtherCAT master slave information: Master AL Status • Read only	
	Bit 0 Init	
	Bit 1 Pre-Operational	
	Bit 2 Safe-Operational	
	Bit 3 Operational	
Bit 4 Error Ind		
0x585F:012	EtherCAT master slave information: Master RX Error Counter (Port 0-3) • Read only	
0x585F:013	EtherCAT master slave information: Master Forwarded RX Error Counter (Port 0-3) • Read only	
0x585F:014	EtherCAT master slave information: Master Processing Unit Error Counter • Read only	
0x585F:015	EtherCAT master slave information: Master PDI Error Counter • Read only	
0x585F:016	EtherCAT master slave information: Master Lost Link Counter (Port 0-3) • Read only	
0x585F:017	EtherCAT master slave information: Master DC Sync 0 Period • Read only	
0x585F:018	EtherCAT master slave information: Master DC Sync 1 Period • Read only	



9.1.9 Error scenarios

The most common errors, faults and possibilities to correct errors can be found in the chapter

▶ [Diagnostics and fault elimination](#) 146

9.1.9.1 "Pre-Operational" EtherCAT state is not achieved

During the start-up of the EtherCAT bus, a check is carried out at the transition from **Init** to **Pre-Operational** to determine whether the physical bus configuration corresponds to the configured bus configuration. If these configurations are different, the master does not enter the **Pre-Operational** state. Furthermore, the slaves are initialized during the transition from **Init** to **Pre-Operational**. If this fails because, for instance, a slave rejects the configuration, the master does not enter the **Pre-Operational** state.

9.1.9.2 "Operational" EtherCAT state is not achieved

The EtherCAT bus can only reach the **Operational** state if the fieldbus has already been set to the **Pre-Operational** state.

If the master is set to the RUN mode, the EtherCAT bus will be set to the **Operational** state.

9.1.9.3 The EtherCAT master reports "SYNC error - BusCycleTask is not in-sync"

Cause	The EtherCAT master BusCycleTask is synchronized with the DC reference clock so that the PLC task and the EtherCAT bus run synchronously. If the EtherCAT master BusCycleTask does not have the highest priority, it can be displaced by other tasks and thus loses its synchronicity.
Error message	EtherCAT_Master: SYNC error - BusCycleTask is not in-sync
Remedies	Check the following settings and correct them if necessary. The bus cycle task of the EtherCAT master must have the highest priority task! <ul style="list-style-type: none"> • Task configuration: Task priority • Device/PLC settings: BusCycle options • EtherCAT_Master/EtherCAT IO mapping: BusCycle options

9.1.9.4 A slave does not accept a cyclic frame

In the **Operational** state, the process data is exchanged cyclically.

If a slave does not accept the cyclical frame (WKC is not increased), this error is caused.

Cause	<ul style="list-style-type: none"> • The bus cable between two EtherCAT devices has been unplugged. • The node at position X is deenergised. • A slave no longer receives cyclical frames, such that the watchdog determined by the device description is triggered. This message will usually only be transmitted if the connection to the master has been re-established.
Error message	<ul style="list-style-type: none"> • EtherCAT_Master: Not all slaves 'Operational' (repeated 100 times) • EtherCAT_Master: Not all slaves 'Operational' (repeated 10 times) • EtherCAT_Master: Cyclic command WKC error (repeated 10 times) [DeviceName] (1002): Communication to device interrupted • EtherCAT_Master: Not all slaves 'Operational' (repeated 1 time) • EtherCAT_Master: Cyclic command WKC error (repeated 1 time) • EtherCAT_Master: Cyclic command WKC error (repeated 100 times)
Remedies	Correct bus topology and restart the EtherCAT fieldbus. ▶ Restart network 74

9.1.9.5 The sync manager configuration is invalid

When the status changes from **Pre-Operational** to **Safe-Operational**, a slave reports **Invalid SyncManager Configuration**.

Cause	<ul style="list-style-type: none"> • One of the slaves does not support an LRW command (Logical Read/Write). • A slave is not written to correctly.
Error message	[DeviceName] (1001): Invalid SyncManager Configuration
Remedies	In the EtherCAT master tab, do not select the "Use LRW instead of LWR/LRD" checkbox.

Configuring the network

EtherCAT master
Error scenarios
The I/O configuration is invalid



9.1.9.6 The I/O configuration is invalid

When the status changes from **Pre-Operational** to **Safe-Operational**, a slave reports **Invalid Output Configuration**.

Cause	The process data configuration of a slave is not correct. <ul style="list-style-type: none"> In case of a modular device such as the I/O system 1000 (EPM-Sxxx), the configuration in the project does not comply with the real assembly. More process data than permissible is mapped for the device.
Error message	<ul style="list-style-type: none"> [DeviceName] (1001): Slave signals Error. AL state: 'PRE-OPERATIONAL' (0x12), AL state code: 'Invalid Input Configuration' (0x1E) [DeviceName] (1001): Slave signals Error. AL state: 'PRE-OPERATIONAL' (0x12), AL state code: 'Invalid Output Configuration' (0x1D)
Remedies	<ul style="list-style-type: none"> In case of modular devices such as the I/O system 1000 (EPM-Sxxx): Correct the control configuration in the »PLC Designer« (adjustment with the real structure). Reduction of the process data: The maximum process data length must not be exceeded (see also the device documentation).

9.1.9.7 Error during process data transfer

A faulty EtherCAT I/O mapping causes errors during the process data transfer.

Cause	Use of logic addresses <ul style="list-style-type: none"> In the »PLC Designer« application, access does not take place symbolically but directly via the I/O addresses (%Ixx, %Qxx) of the EtherCAT input and output objects and the bus structure, the PDO selection etc. have changed.
Error message	-
Remedies	In the »PLC Designer« application, the input and output objects must be accessed via individual non-ambiguous variables. The variable names must comply with the IEC 61131 syntax (no space characters and leading digits in the variable names).

Cause	Manual definition of the logic address in the EtherCAT I/O mapping
Error message	-
Remedies	It is not permissible to manually manipulate the I/O addresses for the EtherCAT bus!

9.1.9.8 The network cable is not connected.

Cause	The bus cable between the Lenze Controller and the first node has been unplugged. If a previously removed bus cable has been plugged back into the first EtherCAT device, the message EtherCAT_Master: EtherCAT cable connected is entered in the logbook of the controller. The EtherCAT connection is re-established. Since the EtherCAT slave sync managers do not receive any messages, a timeout expires and the slaves change to the Safe-Operational state.
Error message	<ul style="list-style-type: none"> EtherCAT_Master: EtherCAT cable not connected ... EtherCAT_Master: EtherCAT cable connected
Remedies	After the bus cable has been plugged in again, restart the EtherCAT fieldbus. ▶ Restart network □ 74

9.1.9.9 A sent frame is not returned to the master

Cause	A frame sent by the master does not return to the master until the next cycle. <ul style="list-style-type: none"> The task utilization is too high, such that a sent frame takes longer than the time to the next start of the bus cycle task. The EtherCAT bus cycle task does not have the highest IEC task priority or another task has the same IEC task priority, such that the EtherCAT bus cycle task is suppressed. Due to an error, the slave does not forward any frames. Only a switch or an ET2000 is connected to the controller, but no further slave.
Error message	<ul style="list-style-type: none"> EtherCAT_Master: Frame response error (repeated 1 time) EtherCAT_Master: Frame response error (repeated 10 times) EtherCAT_Master: Frame response error (repeated 100 times)
Remedies	<ul style="list-style-type: none"> Reduce the program code or increase the bus task cycle time. Correct the bus structure. Correct the slave error. Assign the sole and highest IEC task priority to the EtherCAT bus cycle task.



9.1.9.10 The output shafts make a cracking sound

For motion applications in drive technology, a defective synchronization of 2 shafts leads to an audible clicking noise.

Cause	The task and DC cycle times set in the logic/motion system differ.
Error message	-
Remedies	Adjust the task cycle time and DC cycle time.

Cause	Wiring error: The EtherCAT terminals (IN/OUT) of the slave were inverted. A fieldbus scan does not indicate this error!
Error message	EtherCAT_Master: Set master 'Operational' failed. DCM not in-sync
Remedies	Correct wiring. Afterwards, reload the »PLC Designer« application into the automation system.

Cause	Clicking noise of the shafts after "out-of-sync" If due to a fault, the preset DC deviation limit is exceeded, a re-synchronization of the DC slaves is carried out until the slaves are synchronized again ("In-Sync") and the DC deviation is under the preset limit value again. Currently, the Lenze controller is not re-synchronized to the distributed clocks, such that the sync pulses of the master and the ones of the slaves are different.
Error message	EtherCAT_Master: DC slaves 'out-of-sync'. Deviation xxxxxxxx ns
Remedies	Restart the EtherCAT fieldbus so that the DC slaves and the DC master synchronize again.

Cause	Wrong selection of the device sync source. After the sync source has been changed, the subsequent download and the setting of the slave to the Operational state may fail.
Error message	-
Remedies	<ul style="list-style-type: none"> • Manual setting of the code • Repeated download with PLC start • Restart the EtherCAT fieldbus by resetting the SoftMotion drive

9.1.9.11 The drive shafts do not rotate

Cause	The EtherCAT bus could not be set to the Operational state
Error message	-
Remedies	▶ "Operational" EtherCAT state is not achieved  83

Cause	Clicking noise of the shafts after out-of-sync
Error message	-
Remedies	▶ Error during process data transfer  84

Cause	Clicking noise of the shafts after out-of-sync If due to a fault, the preset DC deviation limit is exceeded, a re-synchronization of the DC slaves is carried out until the slaves are synchronized again (In-Sync) and the DC deviation is under the preset limit value again. Currently, the Lenze controller is not re-synchronized to the distributed clocks, such that the sync pulses of the master and the ones of the slaves are different.
Error message	EtherCAT_Master: DC slaves 'out-of-sync'. Deviation xxxxxxxx ns
Remedies	Restart the EtherCAT fieldbus so that the DC slaves and the DC master synchronize again.

Cause	Faulty SoftMotion scaling/mapping With SoftMotion scaling/mapping, the increments per revolution are not set.
Error message	-
Remedies	<p>Check the following settings and correct them if required:</p> <ul style="list-style-type: none"> • Gearbox ratio in the »PLC Designer« application • Mapping settings in the master configuration <p>When the Lenze controller is started, the complete configuration/PDO mapping is written into the EtherCAT slaves. Mapping entries, e.g. from the »Engineer«, will then be overwritten.</p>

Configuring the network

EtherCAT master
Advanced configuration
Device identification



9.1.10 Advanced configuration

9.1.10.1 Device identification

For identification via EtherCAT, the controller already provides the corresponding EtherCAT slave objects for information.

Parameter

Address	Name / setting range / [default setting]	Information
0x1000	Device type • Read only	EtherCAT device type: Classification according to ETG:
0x1008	Manufacturer device name • Read only	Device name: Type and version of the device:
0x1009	Manufacturer hardware version • Read only	Hardware version: Currently not supported
0x100A	Manufacturer software version • Read only	Software version: Version of the controller firmware
0x1018:001	Identity object: Vendor ID • Read only	Vendor ID: Manufacturer's identification mark
0x1018:002	Identity object: Product ID • Read only	Product ID: Product key and application key
0x1018:003	Identity object: Revision number • Read only	Revision number: Device version
0x1018:004	Identity object: Serial number • Read only	Serial number: Currently not supported



9.1.10.2 Synchronisation with "distributed clocks" (DC)

The **Distributed Clocks** (DC) functionality enables an exact time leveling for applications, in which several axes execute simultaneous, coordinated movements. The data is accepted synchronously with the PLC program. For DC synchronization, all slaves are synchronized with a reference clock, the so-called "DC master".

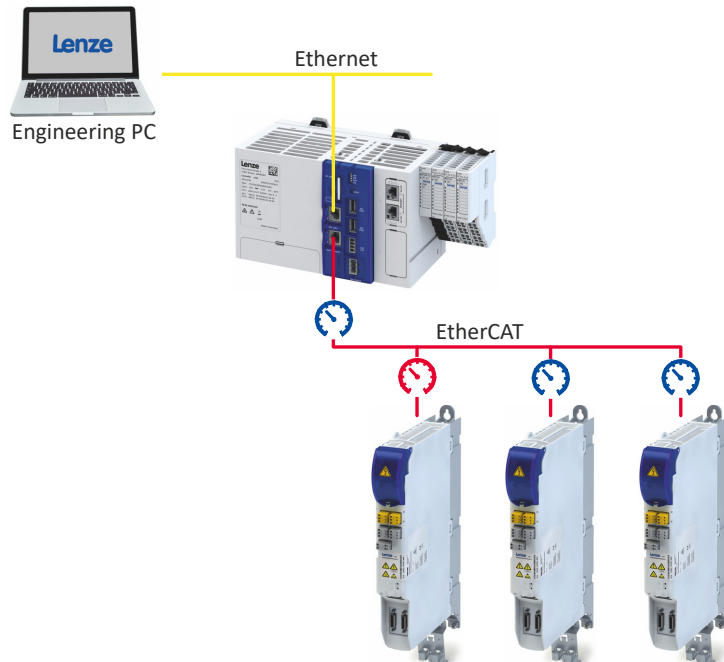

Fig. 3: EtherCAT bus system with c550 controller and i700 servo inverter

The DC synchronization is set using the »PLC Designer«.



DC synchronization is absolutely essential for motion applications!

DC synchronization can be used as an option for logic applications.



DC synchronization only takes place in the "Operational" state.

After a "Out-of-sync", the EtherCAT master synchronizes the slaves. Successful synchronization is indicated by the message "In-Sync".



Not all slaves support the DC functionality. DC-capable and non-DC-capable devices can be mixed when arranging the other slaves. The first EtherCAT slave after the Lenze Controller must be the DC master, which supplies the other EtherCAT devices and the controller with the exact time.



Manual configuration of the slave DC properties requires detailed knowledge of EtherCAT and the field device. DC settings should therefore only be made by experts!

We recommend you to keep the basic DC settings to ensure correct DC synchronization.

Set DC synchronization

The DC synchronization is set using the »PLC Designer«. It ensures that the master and slaves run in phase synchronization: Within a bus cycle, the transfer of the setpoint values and the recording of the actual values in the field devices always take place at exactly the same time. If the Lenze Controller (master) is synchronized with the distributed clocks, the actual values recorded by the slave are sent to the master at the end of the bus cycle and setpoints are sent

Configuring the network

EtherCAT master

Advanced configuration

Synchronisation with "distributed clocks" (DC)



from the master to the slaves for processing. The data is transferred at the next DC synchronization event.

The controller is the EtherCAT master. The cycle time of the bus system is determined by the cycle time of the task, which is assigned to the drives (slaves) integrated in the "PLC Designer". It is between 1 ... 10 ms (according to the technical data). The DC cycle time to be set must match this task cycle time.

Notes:

- The DC cycle time set below is valid for all logic and motion devices synchronized by Distributed Clocks.
- The settings of some slaves must be parameterized locally.
- If the DC setting and the selection of the sync source are contradictory, the devices cannot be set to the "Operational" status.
- The settings for the parameters "Sync cycle time", "Sync phase position", "Sync tolerance" and "Sync PLL increment" cannot be made with EtherCAT. These values are calculated automatically by the EtherCAT communication module and set internally in the device.



Configuring the network

EtherCAT master
Advanced configuration
Synchronisation with "distributed clocks" (DC)

How to set the DC synchronization:

1. Determine task cycle time under "MainTask":

Configuration

Priority (0..31): 1

Type
Cyclic Interval (e.g. t#200ms): t#1ms ms

Watchdog
 Enable
Time (e.g. t#200ms): μ s
Sensitivity:

2. Set the DC cycle time in the master ("EtherCAT_Master") on the "Master" tab according to the determined task cycle time:

EtherCAT_Master

General Settings Diagnostic Master Diagnostic Slaves EtherCAT I/O Mapping Status Information

Autoconfig Master/Slaves

EtherCAT

▲ Distributed Clock ▲ Options

Cycle Time 1000 μ s Use LRW instead of LWR/LRD

3. Select the bus cycle task for the master on the "EtherCAT I/O image" tab:

EtherCAT_Master

General Settings Diagnostic Master Diagnostic Slaves EtherCAT I/O Mapping

IEC Objects

Variable	Mapping	Type
EtherCAT_Master		L_IODrvEtherCAT
EtherCAT_Master-Ta...		L_SuspendWatchdog

= Create new variable = Map to existing variable

Bus cycle options
Bus cycle task Use parent bus cycle setting



If "Cycle settings of the higher-level bus" is selected, the bus cycle task set on the "PLC settings" tab of the Lenze Controller (Device) is used.

Configuring the network

EtherCAT master
Advanced configuration
Synchronisation with "distributed clocks" (DC)



4. In the device tree on the first slave (DC master), select the DC functionality "DC for synchronization" under the master:

Note: If a slave does not support distributed clocks, only "DC unused" can be selected here.

5. Also select the DC functionality "DC for synchronization" on all other slaves that are to use DC synchronization.
DC synchronization is set.

Test of DC synchronicity

DC synchronicity is only available in the **Operational** state.

DC synchronicity check in the »PLC Designer«

- EtherCAT master (Diagnostic master tab):
DC In-Sync is set to TRUE if the DC master and all DC slaves have been synchronized.
- L_ETC_GetMasterDiagnostic function block (FB)/visualization of the L_ETC_GetMasterDiagnostic function block:
DC In-Sync is set to TRUE at the **oDiagnostic.xDC_InSync** output if the DC master and all DC slaves are synchronized.
- L_IODrvEtherCAT function block (FB):
DC In-Sync is set to TRUE at the **xDistributedClockInSync** output if all DC slaves are synchronized.



9.1.11 Modular machine configuration

The modular machine configuration can be used from release 3.10 onwards!

The modular machine configuration enables only one project to be used for all machine variants (maximum configuration).

9.1.11.1 Behavior of the EtherCAT master

When the modular machine configuration is used, the EtherCAT master behavior differs from the behavior known so far:

- As soon as one of the function blocks **L_ETC_MMController** or **L_ETC_MMControllerBus** is instantiated in the PLC application, the EtherCAT master waits with booting the bus.
- Via the function blocks **L_ETC_MMController** and **L_ETC_MMControllerBus**, a service has to be defined that determines the operating mode of the master.
- For one, based on a configuration, the EtherCAT bus can be set to the "Operational" state. Furthermore, a "Second Station Address" (alias address) can be assigned to the EtherCAT slaves.



The function blocks **L_ETC_MMController** and **L_ETC_MMControllerBus** may only be instantiated once within the PLC application.



The configuration is only checked while the EtherCAT master is booting. If slaves are removed or added during operation, respective checks have to be carried out by the PLC application.

Configuring the network

EtherCAT master
Modular machine configuration
Mandatory slaves/Optional slaves



9.1.11.2 Mandatory slaves/Optional slaves

The concept of the modular machine configuration is based on the fact that, depending on the selected configuration within a project, certain EtherCAT slaves have to exist physically at the bus (Mandatory Slaves) or do not have to exist (Optional Slaves). The problem is the clear identification of identically constructed devices with the EtherCAT standard mechanisms. For this purpose, the Second Station Address (alias address) described in the ETG is used which is saved in the EEPROM of the EtherCAT slave.

All EtherCAT slaves must be defined in the PLC application. The order of the definition determines the EtherCAT address by assigning the addresses continuously from '1001'. The address is the biunique identifying feature of a device in the network.

If, for instance, a slave shall contain the application A or the application B, a device has to be created in the project for each application. This way, the applications are identified by the different EtherCAT addresses. The same applies to the process data mapping, terminal configuration etc.

Configurations serve to indicate whether an EtherCAT slave is mandatory or optional. The configurations are summarized in the "mmc-0-conf.csv" file on the Lenze Controller. More identifying features of the slaves are included in the "mmc-0-ident.csv" text file.

► [Configuration files](#) 93

If the device is a **Mandatory Slave** or an **Optional Slave** and whether the slave is available at the EtherCAT bus, is displayed via the properties "IsMandatory" and "IsPresent" of the **ETCSlave** function block.

Identifier/data type	Meaning/possible settings
IsMandatory (GET)	Depending on the currently selected modular machine configuration, the feature is set or not set for the EtherCAT slave. If the modular machine configuration is not used, the value 'TRUE' is automatically returned. <ul style="list-style-type: none">• TRUE: Slave is mandatory• FALSE: Slave is optional
IsPresent (GET)	<ul style="list-style-type: none">• TRUE: The slave is currently available at the bus.• FALSE: The slave is currently not available at the bus.

Example

```
// Mandatory:  
xMandatory_94: = c550_HL_SM.IsMandatory;  
xMandatory_c550_S: = L_c550_SM.IsMandatory;  
xMandatory_c550_D: = L_c550_SM_1.IsMandatory;  
  
// Mandatory:  
xMandatory_94: = c550_HL_SM.IsPresent;  
xMandatory_c550_S: = L_c550_SM.IsPresent;  
xMandatory_c550_D: = L_c550_SM_1.IsPresent;
```

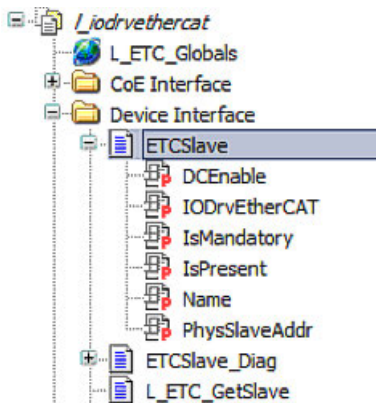



9.1.11.3 Configuration files

The configurations whether certain EtherCAT slaves are mandatory or optional, are summarized in the "mmc-0-conf.csv" text file on the controller. More identifying features of the slaves are included in the text file "mmc-0-ident.csv".

Storage directory: */SDCard/IPC/PLC*



The machine configuration "mmc-0-conf.csv" and the identifying features "mmc-0-ident.csv" are only loaded when a project is loaded.

If an error occurs during the initialization process, a corresponding error message including the line number is output in the controller logbook.

Machine configuration

The machine configuration file "mmc-0-conf.csv" consists of a matrix. All EtherCAT slaves are given horizontally in ascending order, the individual configurations are given vertically. The EtherCAT slaves are referenced based on the EtherCAT address (Fixed Address), the configuration is based on the designator (STRING). If a slave has to be contained in a configuration (Mandatory Slave), it is marked by an 'X' in the following sample table.

Address	1001	1002	1003
Inverter	i700	9400 CiA	9400 AS
Configuration 1: All inverters are configured.	X	X	X
Configuration 2: The 1st and 2nd inverters are configured.	X	X	
Configuration 3: The 1st and 3rd inverters are configured.	X		X

The configuration file does not necessarily have to be available.

Preconditions:

- Manual address assignment via the **L_ETC_MMCAssignAddress** function block
- Operation of the EtherCAT master in the "RUN_WITHOUT_CHECK" mode

Further identification features of the EtherCAT slaves

An EtherCAT slave is identified by the following features:

- Vendor-ID/Product Code/Revision
- Second Station Address (alias address)
- ID selector (is not supported)

Moreover, the modular machine configuration makes it possible to use CoE objects for further identification of the EtherCAT slaves. These additional identification features are contained in

Configuring the network

EtherCAT master
Modular machine configuration
Configuration files



the "mmc-0-ident.csv" text file. If the identification file is not available on the Lenze controller, no identification features are used.

The structure of the text file "mmc-0-ident.csv" is strictly defined. All columns must be provided in the order specified or may contain an empty string. The EtherCAT slaves are arranged in ascending order of their address according to the sample table.

Name	Address	Index	Subindex	Type	Data
L_i700_SM	1001	16#1018	1	DWORD	03 B0 00 00
	1001	16#1019	2	DWORD	02 00 07 69
L_9400_HL_S	1002	16#1020	1	DWORD	3B 00 00 00
	1002	16#1021	2	DWORD	3D 9D 0738
L_9400_HL_S	1003	16#1022	1	DWORD	3B 00 00 00
	1003	16#1023	2	DWORD	3D 9D 07 38

Column	Description	Notation
Name	Device name of the EtherCAT slave (optional)	<i>STRING</i>
Address	Address of the EtherCAT slave (required) <ul style="list-style-type: none">If no additional identification features are required for a slave, the entire line must be omitted.If more than one identification feature is to be requested for a slave, a completely new line has to be created.	<i>INT</i> (decimal)
Index	Index of the CoE object to be requested. (required)	<i>INT</i> (hexadecimal with prefix 16#)
Subindex	Subindex of the CoE object to be requested. (required)	<i>SINT</i> (decimal)
Type	Type of the CoE object to be requested. (required) <ul style="list-style-type: none">Only BYTE, WORD and DWORD are supported.	<i>IEC basic types</i> (String)
Data	Data that must be contained in the specified CoE object. (required) <ul style="list-style-type: none">The number of bytes must comply with the type.	<i>Octet stream</i> (hexadecimal with spaces) Example: <ul style="list-style-type: none">0x00001234466034 12 00 00
Comment	Comment field for the user. (optional)	<i>STRING</i>

Dependencies between configuration files and services

Depending on the selected service, information from the machine configuration file "mmc-0-conf.csv" and the file for further identification features of the slaves "mmc-0-ident.csv" is required. If the files are not available or if there is a "Parsing Error", one of the following error messages results when a service is activated: "CONFIG_FILE_ERROR" or "IDENT_FILE_ERROR".



9.1.11.4 Address assignment

Before the EtherCAT master in the modular machine configuration can switch to the operating mode "RUN_[...]" each EtherCAT slave has to be assigned a "Second Station Address" (alias address). For this purpose, the function block **L_ETC_MMController** offers the services "ADDR_ASSIGNMENT_EXTERNALLY" and "ADDR_ASSIGNMENT_CONFIG_SLAVEORDER".

For all address assignment services, the EtherCAT master reads out the relevant information from the slaves to create a temporary configuration and sets the slaves to the "Pre-Operational" state. For this purpose, the master assigns the addresses for the slaves connected in ascending order starting with "1". Thus, the address is identical to the position of the slave in the network.

ADDR_ASSIGNMENT_EXTERNALLY service

For this service, the "Second Station Address" (alias address) can be assigned manually from the PLC application (e.g. via a visualization). This service provides the CoE function blocks. Parameters such as vendor ID, product code, revision, and serial number can be read out from the slave or parameters can be described for "Optical Tracking". If a slave has been clearly identified and assigned, the **L_ETC_MMAssignAddress** function block can be used to write the address to the slave.

ADDR_ASSIGNMENT_CONFIG_SLAVEORDER service

For this service, the "Second Station Address" (alias address) is automatically assigned. For this purpose, a configuration has to be specified, e.g. via the machine configuration file "mmc-0-conf.csv". Based on the configuration, the EtherCAT master receives information on which slaves are to be expected at the bus. If the slaves are actually available, the "Second Station Address" is written to the slaves. Here, in addition to the vendor ID and product code, the current ascending order of the slaves at the bus is important.

Configuring the network

EtherCAT master
Modular machine configuration
Error messages



9.1.11.5 Error messages

Error message	Error type	Description
MMC - address assignment - done	Info	The address assignment has been completed successfully.
MMC - address assignment - invalid device on position ... (...../.../...)	ERROR	During the address assignment by means of the ADDR_ASSIGNMENT_EXTERNALLY or ADDR_ASSIGNMENT_CONFIG_SLAVEORDER service, a slave has been detected unexpectedly at the given position.
MMC - address assignment - less slaves connected (...) than configured (...)	ERROR	During the address assignment, less slaves are connected to the physical EtherCAT bus than specified in the active configuration.
MMC - address assignment - more slaves connected than configured	ERROR	During the address assignment, more slaves are connected to the physical EtherCAT bus than specified in the active configuration.
MMC - address assignment - writing address ... at position ... by CoE ... (error ...)	ERROR	During the address assignment, an error has occurred for the slave at the given position. For further information see general error codes (L_ETC_ERRORCODE).
MMC - address assignment - writing address ... at position ... failed (error ...)	ERROR	During the address assignment, an error has occurred for the slave at the given position. For further information see general error codes (L_ETC_ERRORCODE).
MMC - address assignment - written address ... at position ... successfully	Info	The address has been successfully assigned to the slave at the given position.
MMC - devices not ascending or device(s) missing at line ... (...)	ERROR	In the "mmc-0-conf.csv" configuration file, the slaves are not specified in ascending order (starting with '1001') or are missing. Or the address space is incomplete.
MMC - duplicated alias address ... at positions ... and ...	ERROR	While the EtherCAT bus was booted and the slaves were checked, several slaves were found with identical "Second Station Address" (alias address) at the given position. The first slave behind the EtherCAT master has the position '1'.
MMC - Error in configuration files	ERROR	Errors were detected during the analysis of the "mmc-0-conf.csv" configuration file or the "mmc-0-ident.csv" identification file. Additional information about the error is displayed in the logbook further above.
MMC - file does not exist ...	Info	The "mmc-0-conf.csv" configuration file or the "mmc-0-ident.csv" identification file have not been found in the directory .../USBStorage/IPC/PLC or .../SDCard/IPC/PLC. As both files do not have to be available in the system (depending on the service), this merely serves as information.
MMC - Internal error (...)	ERROR	An internal error has occurred. The internal error number is output in the error message. Please contact Lenze customer service!
MMC - invalid alias address ... at position ... (...../.../...)	ERROR	While the EtherCAT bus was booted and the slaves were checked, a slave with an invalid or unexpected "Second Station Address" (alias address) was detected at the specified position. The first slave behind the EtherCAT master has the position '1'. Parameters in parentheses: Vendor-ID/Product Code/Revision/Serial Number.
MMC - invalid configuration	ERROR	An action has been aborted because no valid configuration is active.
MMC - mandatory slave ... is not present	ERROR	While the EtherCAT bus was booted and the slaves were checked, a mandatory slave was not found at the bus. In the error message, the EtherCAT address or "Second Station Address" (alias address) of the slave is given.
MMC - 'Modular Machine Configuration' is active - EtherCAT Master is controlled by L_ETC_MMController	Info	The L_ETC_MMController function block is used in the PLC program. The behavior of the EtherCAT master is controlled by the function block.
MMC - no configuration checks	Info	While the EtherCAT bus is booted, the configuration is not checked because the RUN_WITHOUT_CHECK service is active.
MMC - no valid service active	ERROR	When using the L_ETC_MMController function block, there was an attempt made to boot the EtherCAT bus (xRestart = TRUE). But no service is active.
MMC - number of device in device tree differs at line ... (...)	WARNING	The number of slaves from the "mmc-0-conf.csv" configuration file is greater than defined in the »PLC Designer« project. This is a warning because the excessive devices from the configuration are simply ignored.
MMC - optional slave ... is present, but not allowed	ERROR	While the EtherCAT bus was booted with the RUN_OPTIONAL_SLAVES_PROHIBITED service active, a "non-mandatory" slave was found.
MMC - parsing error at line ... (...)	ERROR	Errors were detected in the specified line number during the analysis of the "mmc-0-conf.csv" configuration file or the "mmc-0-ident.csv" identification file. The line number starts with '1'.
MMC - parsing file succeeded ...	Info	The specified "mmc-0-conf.csv" configuration file or the "mmc-0-ident.csv" identification file have been analyzed without any errors.
MMC - service ... started, configuration '...'	Info	A service has been started with the given configuration.
MMC - service stopped	Info	A service has been stopped by the user via the L_ETC_MMController function block or via a reset.
MMC - slave ... ident data failed - CoE ... (set .../act ...)	ERROR	The expected and current parameter contents do not match. An error occurred in the specified slave while the EtherCAT bus booted and the additional identification parameters from the "mmc-0-ident.csv" configuration file were checked.



Configuring the network

EtherCAT master
Modular machine configuration
Error messages

Error message	Error type	Description
MMC - slave ... ident failed - CoE ... (error ...)	ERROR	An error occurred in the specified slave while the EtherCAT bus booted and the additional identification parameters from the "mmc-0-ident.csv" configuration file were checked. For further information see general error codes (L_ETC_ERRORCODE).
Modular machine configuration: Only one instance of L_ETC_MMController allowed!	ERROR	This message is transmitted when the EtherCAT master configuration is generated if more than one instance of the L_ETC_MMController function block is used in the application. Please note: An instance might also have been created in a library!



9.2 EtherCAT slave

Chapter overview

- ▶ Commissioning [100](#)
- ▶ Process data transfer [101](#)
- ▶ Parameter data transfer [102](#)
- ▶ EtherCAT I/O mapping status [103](#)
- ▶ Diagnostics [104](#)
- ▶ Error scenarios [105](#)



EtherCAT® (Ethernet for Controller and Automation Technology) is an Ethernet-based fieldbus system which fulfils the application profile for industrial realtime systems.

- EtherCAT® is a registered trademark and patented technology, licensed by Beckhoff Automation GmbH, Germany.
- Detailed information on EtherCAT can be found on the web page of EtherCAT Technology Group (ETG): <http://www.ethercat.org>

Preconditions

- The device is equipped with the **EtherCAT device** network option. ▶ [Features 16](#)

EtherCAT device connection

- The EtherCAT device connection is established using the RJ45 sockets **X246** and **X247**.
- A CAT 5/5e Ethernet cable can be used for the connection to the network, 2-pair with AWG22 or 4-pair with AWG22/24.



More information about connections can be found on the Internet:

<http://www.ethercat.org> → ETG1600_V1i0i2_G_R_InstallationGuideline.pdf



Fig. 4: EtherCAT device connections **X246** and **X247**



Typical topology

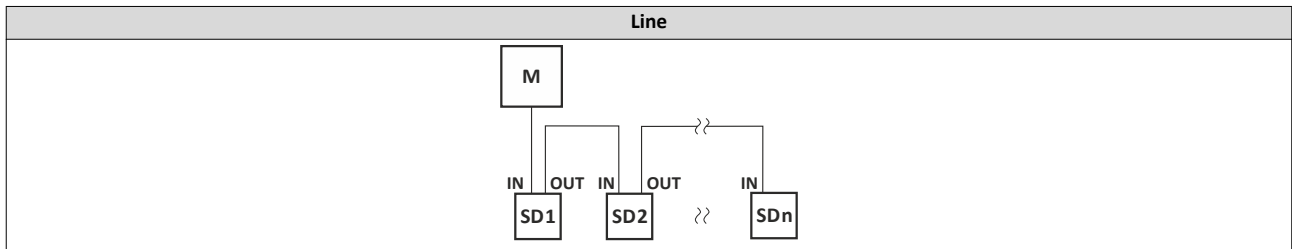

M Master
SD Slave device

Configuring the network

EtherCAT slave
Commissioning
EtherCAT device configuration with »PLC Designer«



9.2.1 Commissioning

For commissioning a control unit with an EtherCAT device located in a lower-level EtherCAT network, it is necessary to perform a custom configuration of the master and the device.

Both configurations must be represented identically on the master control unit (e.g., using the software TwinCAT 3.x® from Beckhoff) and the slave control unit (with the engineering tool "PLC Designer" from Lenze). Failure to do so will render a transition to the "Operational" status impossible.

Configuration of the EtherCAT device using the "PLC Designer"

The term "EtherCAT device" is used to describe the EtherCAT slave interface of the slave control unit. The EtherCAT device specifies the process image which needs to be reproduced identically in the master configuration for the EtherCAT slave.

How to integrate EtherCAT devices in the control configuration:

1. Select the "Add device" command in the context menu of the target system (device, Lenze controller, etc.) to extend the control configuration with the EtherCAT device.

The EtherCAT device is located in the category under /Fieldbusses/EtherCAT/Slave/EtherCAT-Device

2. Name the inserted EtherCAT device sensibly.

You can enter a name by clicking on the element. The designations must only contain the characters "A ... Z", "a ... z", "0 ... 9", or "_" and must not begin with a digit.

3. Go to the context menu of the EtherCAT device and execute the "Add device" command.
4. In the dialog box that appears, select the I/O modules to be used for the EtherCAT device and add them to the EtherCAT device by clicking the "Add device" button. The structure of the process image is defined via the modules.
5. In the tab for the module, define the variables for the IO signals.

The control configuration of the EtherCAT device in the "PLC Designer" is completed.

Continue with the control configuration of the EtherCAT slave; see [EtherCAT-Slave configuration in Beckhoff TwinCAT 3.x®](#) [□ 101](#).

9.2.1.1 EtherCAT device configuration with »PLC Designer«

How to integrate the EtherCAT IO device in the control configuration:

1. Select the "Add device" command in the context menu of the target system (device, Lenze controller, etc.) to extend the control configuration with the IO device.

The EtherCAT device is located in the category under /Fieldbusses/EtherCAT/Slave/EtherCAT-Device

2. Name the inserted IO device sensibly.

You can enter a name by clicking on the element. The designations must only contain the characters "A ... Z", "a ... z", "0 ... 9", or "_" and must not begin with a digit.

3. Go to the context menu of the EtherCAT device and execute the "Add device" command.
4. In the dialog box that appears, select the I/O modules to be used for the EtherCAT device and add them to the EtherCAT device by clicking the "Add device" button. The structure of the process image is defined via the modules.
5. In the tab for the module, define the variables for the IO signals.

The control configuration of the EtherCAT device in the »PLC Designer« is completed.

Continue with the configuration of the EtherCAT slave with TwinCAT 3.x® (see next chapter).



9.2.1.2 EtherCAT-Slave configuration in Beckhoff TwinCAT 3.x®

How to integrate the EtherCAT slave in TwinCAT 3.x®:

1. Install device description ▶ [Device description file](#) 101
2. In the context menu of the EtherCAT device (master), select the EtherCAT slave using the "Add New Item ..." command. In this case, "cxxx" refers to the control unit model (e.g. c430, c520, c550). The EtherCAT slaves are located in the group "/Lenze/Controller".
3. Defining the process image: In the slots tab for the cxxx EtherCAT slave object, add the modules to be used.

The slots must be added continuously from the first (topmost) slot without any gaps.

If the EtherCAT slave is at least in the "Pre-Operational" status, the module can also be configured via the parameter 0xF050 "Detected Module Ident List" via a device scan.

The configuration of the EtherCAT slave in TwinCAT 3.x® is now complete.

9.2.1.3 Device description file

To integrate the EtherCAT slave in a master configuration, the device description file in the engineering tool for the project planning of the network must be installed.

Downloading ESI files: The designation of the ESI device description file is "Lenze_cxxx_ECS_V<Version>.xml"

Wildcard	Info
Version	8-digit version number in the format AABBCDD (Format AA.BB.CC.DD: AA major, BB minor version number)

9.2.2 Process data transfer

The process data interface is determined by the EtherCAT device via the number and type of modules inserted into the slots.

For the compilation of the process data, modules with the same name are available for the EtherCAT device and the EtherCAT slave:

Module	Info
Mixed In / Out Word 0002	Rx and Tx process data object, each with 2 words (RxPDO 4 bytes, TxPDO 4 bytes)
Mixed In / Out Word 0004	Rx and Tx process data object, each with 4 words (RxPDO 8 bytes, TxPDO 8 bytes)
Mixed In / Out Word 0008	Rx and Tx process data object, each with 8 words (RxPDO 16 bytes, TxPDO 16 bytes)
Mixed In / Out Word 0016	Rx and Tx process data object, each with 16 words (RxPDO 32 bytes, TxPDO 32 bytes)
Mixed In / Out Word 0032	Rx and Tx process data object, each with 32 words (RxPDO 64 bytes, TxPDO 64 bytes)
Mixed In / Out Word 0064	Rx and Tx process data object, each with 64 words (RxPDO 128 bytes, TxPDO 128 bytes)
Mixed In / Out Word 0096	Rx and Tx process data object, each with 96 words (RxPDO 192 bytes, TxPDO 192 bytes)

The length of the process data is 2 ... 96 words (max. 32 PDO and max. 512 words per direction).

Configuring the network

EtherCAT slave
Parameter data transfer



9.2.3 Parameter data transfer

The EtherCAT device possesses two categories of parameters:

- Standard communication parameters (index range 0x1000 ... 0x1FFF and 0xF050, Detected Module List).

These parameters are only visible/accessible for the EtherCAT masters connected via this interface.

The controller itself is unable to access the standard communication parameters.

- For diagnostic parameters, see [EtherCAT device diagnostics](#) 104

Standard communication parameters

Address	Name / setting range / [default setting]	Information
0x1000	Device type	RO
0x1001	Error register	RO
0x1008	Manufacturer's device name	RO
0x1009	Manufacturer's hardware version	RO
0x100A	Manufacturer's software version	RO
0x1018	Identity object	RO
0x1630 0x164F	RxPDO mapping	RW
0x1A30 0x1A4F	TxPDO mapping	RW
0x1C00	Sync manager type	RO
0x1C12	SM2 PDO assignment	RW
0x1C13	SM3 PDO assignment	RW

Tab. 1: Standard communication parameters (via EtherCAT interface)

Address	Name / setting range / [default setting]	Information
0xF050	Detected module list	RO/ARRAY OF UDINT Array with objects of type "UDINT" which contains the currently configured/detected modules. Can be used for a device scan for reading the current configuration. SubIndex 0 (USINT) contains the currently configured/detected number of modules.

Tab. 2: Detected module list (via EtherCAT interface)



9.2.4 EtherCAT I/O mapping status

In addition to the actual I/O mapping of the process data, the EtherCAT device also has input and output channels in which additional information is supplied for the PLC application.

This information can be accessed directly from the PLC code.

Name	Info
Configuration valid	RO/BOOL Indicates whether the currently active configuration is valid. FALSE: There is no valid configuration. TRUE: Configuration is valid. A configuration consists both of a component from the slave application (EtherCAT device) and a component of the configuration from the EtherCAT master. These must match.
EtherCAT state	RO/UINT Specifies the current EtherCAT status of the slave. 0: No EtherCAT module 1: Initialization 2: Pre-Operational 3: Bootstrap 4: Safe-Operational 8: "Operational"
Process data valid	RO/BOOL This flag indicates whether the process data is valid. FALSE: The process data is not valid. TRUE: The process data is current and valid.
Watchdog error	RO/BOOL This flag indicates whether there is a SyncManager watchdog error. FALSE: No SyncManager watchdog error. TRUE: The SyncManager watchdog was triggered. The value of the watchdog is set by the configuration tool of the EtherCAT master.

Configuring the network

EtherCAT slave
Diagnostics
Status LEDs







9.2.5 Diagnostics

9.2.5.1 Status LEDs

Notes on the connection status of the EtherCAT device interface is provided by the LEDs "BUS RUN" and "BUS ERR" of the EtherCAT module (front of device).

In addition, the LEDs "L/A" at the RJ45 sockets indicate the connection status to the network.

LED "BUS RUN" (green)	Status	Meaning
Off	INIT	The EtherCAT device is in the "Initialization" status.
 blinking	Pre-Operational	The EtherCAT device is in the "Pre-Operational" status.
 Single flash	Safe-Operational	The EtherCAT device is in the "Safe-Operational" status.
 On	"Operational"	The EtherCAT device is in the "Operational" status.

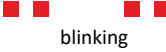
LED "BUS ERR" (red)	Status	Meaning
Off	No fault	No fault
 blinking	Impermissible settings	Impermissible settings/configuration. The settings and/or configuration are made by the EtherCAT master and/or the configuration tool. A more advanced analysis must be performed by the master or the slave controller logbook.
 blinking	Watchdog	Timeout during PDO communication (e. g. Ethernet cable removed)
 On (red)	Fault	Communication error (e. g. incorrectly plugged network option)

LED "L" (Link, green)	Status	Meaning
Off	Not connected	No connection to the network
 On	Connected	A physical connection to the network is available

LED "A" (Activity, yellow)	Status	Meaning
 On or flickers	Traffic	Data is exchanged via the network

9.2.5.2 EtherCAT device diagnostics

The diagnostic parameters are parameters of the controller.

The master is unable to access these parameters via the EtherCAT device interface.

Parameter

Address	Name / setting range / [default setting]	Information
0x2362:007	Active EtherCAT settings: Tx length • Read only	Display of the length of the transmitted cyclic data in bytes. A value other than zero is only displayed if the master / slave process data is configured correctly.
0x2362:008	Active EtherCAT settings: Rx length • Read only	Display of the length of the received cyclic data in bytes. A value other than zero is only displayed if the master / slave process data is configured correctly.



Address	Name / setting range / [default setting]	Information
0x2368	EtherCAT status • Read only	Display of the current network status.
	0 No EtherCAT module	
	1 Initialization	Network initialization is active.
	2 Pre-Operational	The network is active.
	3 Bootstrap	Firmware update active.
	4 Safe-Operational	<ul style="list-style-type: none">• SDO transmission (CoE communication via mailbox) is possible.• PDO transmission:<ul style="list-style-type: none">- The input data in the process image are updated.- The output data from the process image are not transmitted.
8 Operational	Normal operation	
0x2369	EtherCAT error • Read only	
	Bit 0 Watchdog elapsed	The SyncManager watchdog has triggered.
	Bit 2 Invalid configuration	The configuration sent by the EtherCAT master is invalid.
	Bit 3 Stack init error	Internal error when initializing the interface.
	Bit 4 Invalid process data	The flag indicates that the process data is invalid.

9.2.6 Error scenarios

The most common errors, faults and possibilities to correct errors can be found in the chapter [▶ Diagnostics and fault elimination](#) 146

9.2.6.1 No EtherCAT module plugged or detected

Even though the EtherCAT module is inserted and defined as an EtherCAT device in the project, it is not detected.

- The **EtherCAT device** icon in the »PLC Designer« remains red.
- The diagnostic parameters remain set to zero.
- The status "I/O Mapping" remains set to zero.
- The parameters 0x231F:001/002 do not display an EtherCAT device module.

Remedy

- Check that the EtherCAT device module is properly fitted in the slot, remove and re-insert if necessary.
- Check for problems with contacts.

9.2.6.2 Process data mapping in master / slave does not match

- The "EtherCAT device" icon in the »PLC Designer« remains red.
- The EtherCAT master issues one of the following messages for the slave during the transition to the "Safe-Operational" status:
 - CoE 0x16xx:0 SDO abort 'object cannot be mapped in PDO'.
 - CoE 0x1C1x:0 SDO abort 'object cannot be mapped in PDO'.
- The 'Process Data Valid' flag in 'Status I/O Mapping' remains set to FALSE.

Remedy

- Check the mapping in the master and slave.
- Perform a device scan in the master when the EtherCAT slave is at least in the "Pre-Operational" status.



If modules that were not configured on the EtherCAT master are added to the EtherCAT device, the EtherCAT slave will enter the "Operational" status without data exchange taking place with the EtherCAT master.



9.3 PROFINET IO-Device

Chapter overview

- ▶ Commissioning [109](#)
- ▶ Basic setting and options [111](#)
- ▶ Process data transfer [112](#)
- ▶ Parameter data transfer [113](#)
- ▶ Monitoring [114](#)
- ▶ Diagnostics [115](#)



PROFINET® (Process Field Network) is a real-time capable network based on Ethernet.

- PROFINET® is a registered trademark and patented technology licensed by the PROFIBUS & PROFINET International (PI) user organization.
- Detailed information on PROFINET can be found on the web page of the user organization: <http://www.profibus.com>
- PROFINET transmits, between the IO-Devices and a IO-Controller (PLC), parameter data, configuration data, diagnostic data, alarm messages, and process data.
- The data is transmitted as a function of its time-critical behavior via corresponding communication channels.
- The device is implemented as a PROFINET IO-Device in a PROFINET RT network.
- The PROFINET connections are realized as standard RJ45 sockets.

Voraussetzungen

- The device is equipped with the "PROFINET" network option via slot 1. ▶ [Features 16](#)



Device description files for Lenze products can be found on the Internet:
www.Lenze.com → Downloads → Product-related Application Knowledge Base articles

PROFINET connection

- PROFINET is connected via the RJ45 sockets. **X256** and **X257**.
- An Ethernet cable CAT 5/5e can be used for the connection to the network, 2-pair with AWG22 (American Wire Gauge) or 4-pair with AWG22/24.



More information about connections can be found on the Internet:
www.profibus.org → PROFINET Cabling and Interconnection Technology



Fig. 5: PROFINET connections X256 and X257

Typical topologies

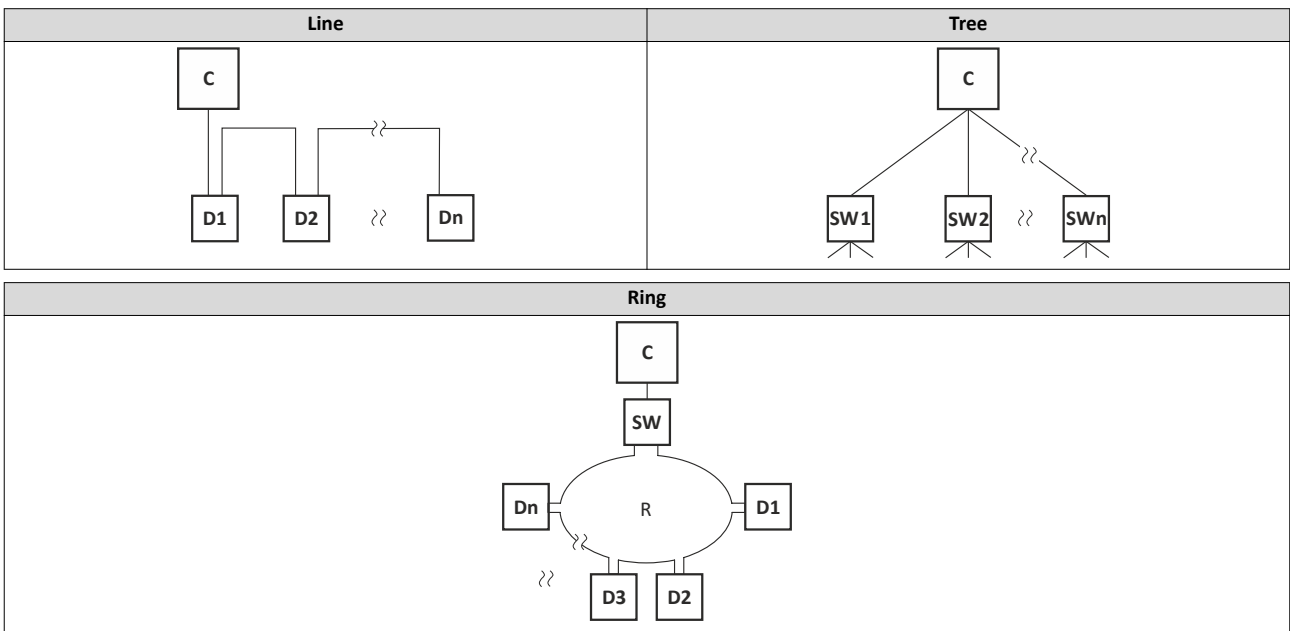

C IO controller
D IO device

SW Switch SCALANCE (MRP capable)
R Redundant domain

Configuring the network

PROFINET IO-Device



Technical data

Range	Values
Communication profile	PROFINET
Communication medium/cable type	S/FTP (Screened Foiled Twisted Pair, ISO/IEC 11801 or EN 50173), CAT5e Standard Ethernet (acc. to IEEE 802.3), 100Base-TX (Fast Ethernet)
Network topology	Line, star, and tree
Type within the network	PROFINET I/O-Device (slave)
Max. cable length	100 m between two devices
I/O data (PDO data)	<ul style="list-style-type: none"> • Max. 244 PDOs: freely configurable, regardless of their direction (In, Out, In/Out) • Max. 1024 input bytes and max. 1024 output bytes • Scaling: bytes: 1, 2, 4, 8, 16, 32, 64, 128, 192, 256, 320, 384, 448, 512, 1024 Word: 1, 2, 4, 8, 16, 32, 64, 128, 192, 256, 320, 384, 448, 512 • The combination of I/O data in one slot is possible.
Communication type	PROFINET I/O cyclic
Functions	<ul style="list-style-type: none"> • Transmission of cyclic process data • Context Management via CL-RPC (Connectionless Remote Procedure Call) The Context Management Protocol is used for establishing and terminating connections, requesting resources, exchanging configuration and diagnostic information, uploading/downloading records. • Setpoint/actual comparison of the PROFINET configuration
Special features in the Lenze automation system	<p>Configuration in the »PLC Designer«:</p> <ul style="list-style-type: none"> • No submodules • Only one device instance is supported. <p>No support of</p> <ul style="list-style-type: none"> • acyclic write and read requests • DCP (Discovery and basic Configuration Protocol) • RTP (Real-Time Transport Protocol) over UDP (User Datagram Protocol) • Multicast communication • Process/diagnostic alarms • Generic diagnostics, channel diagnostics
Minimum cycle time	2 ms



9.3.1 Commissioning

1. Importing IO devices into the control configuration:

1. Select the "Add device" command in the context menu of the target system (device, Lenze controller, ...) to extend the control configuration with the IO device.
2. Name the inserted IO device sensibly.



You can enter a name by clicking on the element. The names must only contain the characters "A ... Z", "a ... z", "0 ... 9" or "_" and must not begin with a digit.

3. Execute the "Add device" command in the context menu of the IO device.
4. In the dialog box that appears, select the I/O modules to be used for the IO device and add it to the IO device by clicking the "Add device" button.
5. Set the IP address, subnet mask, gateway address and the station name of the IO device in the PROFINET parameters (Fieldbus section).

2. Load the network configuration into the master:

1. Log off: Menu command Online → Log off or <Ctrl>+<F8>.
 2. Compile: Menu command "Build → Compile" or <F11>.
 3. Log in: Menu command "Online → Log in" or <Alt>+<F8>.
- The configuration, the parameter settings and the PLC program are loaded into the IO controller. Afterwards, all IO devices are initialized.



These steps must be carried out after every change within the »PLC Designer« project. An already existing configuration and an existing PLC program in the IO controller will be then overwritten.

9.3.1.1 Restarting or stopping the communication

The communication needs to be restarted after changes to the interface configuration (e. g. station address and IP configuration) so the changed settings become effective without switching the voltage.

► [Station name and IP configuration](#) 111

There are two options for restarting the communication:

- Set [0x2380](#) to 1 (restart with current values)
- Set [0x2380](#) to 2 (restart with the values saved last)

The following option can be used to stop communication:

- Set [0x2380](#) to 5 (stop network communication)

Parameter

Address	Name / setting range / [default setting]	Information
0x2380	PROFINET communication	Restart / stop communication <ul style="list-style-type: none"> • When the device command has been executed successfully, the value 0 is shown.
	0 No action/no error	Only status feedback
	1 Restart with current values	Restart communication with the current values.
	2 Restart with stored values	Restart communication with the values of the PROFINET parameters that have been saved last (0x2381:001 ... 0x2381:009).
	5 Stop network communication	Stop communication
	10 In progress	Only status feedback
	11 Action cancelled	
	12 Fault	

Configuring the network

PROFINET IO-Device
Commissioning
Settings in the Siemens »TIA Portal«



9.3.1.2 Settings in the Siemens »TIA Portal«



Here, commissioning with the Siemens »TIA Portal« is described. Please note that in the default setting of the Siemens »TIA Portal« changes of network parameters carried out by a Lenze engineering tool (e. g. »PLC Designer«) may be overwritten.

1. Go to the device configuration and open the **net view** to drag the controller from the catalog to the net view of the PROFINET.
2. Assign the controller to the associated IO-Controller.
3. Mark the controller and change to the **device view**.
4. Set the IP address and the station name ("PROFINET device name") in **Properties**.

See: ▶ [Station name and IP configuration](#) 111



In order that the controller can be identified via Ethernet when the IO controller is switched off, it is necessary that the station name and the IP configuration are saved in the device with mains failure protection via the separate entry with the Lenze engineering tool. ▶ [0x2022:003](#)

See: ▶ [Saving the parameter settings](#) 42

5. Below the device name and the name of the device description file, the device view shows the pre-assignment of the output and input process data words.

In Slot 1, pre-assigned process data words can be changed.

6. Save the project in the engineering tool.
7. Load the configuration into the IO-Controller.
8. Set the IO-Controller to **RUN**.

9.3.1.3 Device description file

The device description file must be installed in the engineering tool used for configuring the network (e. g. Siemens »TIA Portal«).



Device description files for Lenze products can be found on the Internet:
www.Lenze.com → Downloads → Product-related Application Knowledge Base articles

The name of the device description file is as follows:

"GSDML-V<x>.<zz>-Lenze-C<NNN>PN<Version>-<yyyy><mm><dd>.xml".

Wildcard	Information
x	Main version of the GSDML scheme used
zz	One-digit or two-digit subversion of the GSDML scheme used
NNN	Specification of the device designation
Version	First version of the software that can be used with this GSDML.
yyyy	Year of publication
in (mm)	Month of publication
dd	Day of publication

Define the user data length

The configuration is supported by 250 process data bytes (up to 244 slots and 1440 bytes of max. IO data per direction).

Example of selecting the device description file:

- Mixed_In_Out_Byte_0008 8 process data bytes (In and Out direction)



9.3.2 Basic setting and options

9.3.2.1 Station name and IP configuration

The station name and the IP configuration can be assigned by the IO-Controller. These settings enable the IO-Controller to identify the devices in the network and manage the data exchange.

The station name and the IP configuration can also be assigned by the »Engineering Tool«.

- The station name of the IO device must be entered with permissible characters according to the PROFINET specification. [▶ 0x2381:004](#)
- Display of the currently used station name: [▶ 0x2382:004](#)
- The IP configuration comprises the assignments of:
 - IP address [▶ 0x2381:001](#)
 - Subnet mask [▶ 0x2381:002](#)
 - Gateway address [▶ 0x2381:003](#)
- Display of the actual IP configuration: [▶ 0x2382:001 ... 0x2382:003](#)



Save the station name and the IP configuration in the IO Device with line voltage failure protection so the IO Device can be identified via PROFINET if the IO controller is switched off. [0x2022:003](#)

[▶ Saving the parameter settings](#) [📖 42](#)



An invalid station name or the assignment of invalid combinations of the IP address, subnet mask, and gateway address can have the consequence that no connection to PROFINET can be established.

In case of impermissible settings, the red LED "bus ERR" is blinking and the error message "PROFINET: Stack initialization error [0x8192]" is output.

[▶ Status LEDs](#) [📖 115](#)

Parameter

Address	Name / setting range / [default setting]	Information
0x2381:001	PROFINET settings: IP address 0.0.0.0 ... [0.0.0.0] ... 255.255.255.255	Set IP address • A changed value will only be effective after the PROFINET communication is restarted (0x2380 = 1).
0x2381:002	PROFINET settings: Subnet 0.0.0.0 ... [0.0.0.0] ... 255.255.255.255	Set subnet mask • A changed value will only be effective after the PROFINET communication is restarted (0x2380 = 1).
0x2381:003	PROFINET settings: Gateway 0.0.0.0 ... [0.0.0.0] ... 255.255.255.255	Set gateway address • A changed value will only be effective after the PROFINET communication is restarted (0x2380 = 1). • The gateway address is valid if the network address of the IP address is identical to the gateway address. In this case, no gateway functionality is used. • DHCP is not supported.
0x2381:004	PROFINET settings: Station name ["0"]	Set station name • A changed value will only be effective after the PROFINET communication is restarted (0x2380 = 1).
0x2381:005	PROFINET settings: I&M1 System designation ["0"]	Input/output of the I&M1 system designation • The default setting is an empty string.
0x2381:006	PROFINET settings: I&M1 Installation site ["0"]	Input/output of the I&M1 location identification code • The default setting is an empty string.
0x2381:007	PROFINET settings: I&M2 Installation date ["0"]	Input/output of the I&M2 date of installation • The default setting is an empty string.
0x2381:008	PROFINET settings: I&M3 additional information ["0"]	Input/output of the I&M3 additional information • The default setting is an empty string.

Configuring the network

PROFINET IO-Device
Process data transfer
Suppress diagnostic messages to the IO controller



9.3.2.2 Suppress diagnostic messages to the IO controller

► **0x285A:001** serves to set which error response in the device suppresses the alarm message to the IO-Controller.

Parameter

Address	Name / setting range / [default setting]	Information
0x285A:001	Diagnostic configuration: Alarm suppression 0 ... [0] ... 65535	Bit coded selection of error responses which suppress the alarm message to the IO controller. <ul style="list-style-type: none">• Bit x = 1 = suppress alarm message.• In the default setting "0", an alarm message is displayed for all error responses.
	Bit 0 Information	
	Bit 1 Warning	
	Bit 2 Warning locked	
	Bit 3 Trouble	
Bit 4 Fault > application quick stop > quick stop		

9.3.3 Process data transfer

Process data serve to control the device.

- The process data is transferred cyclically between the IO-Controller and the IO-Devices participating in PROFINET.
- The process data can be directly accessed via the IO Controller. The data in the PLC, for instance, are directly stored in the IO area.
- The maximum length of the process data is 1 ... 1440 bytes per direction.
- The maximum number of PDO slots is 244 per direction with a maximum of 250 bytes within the slot.
- The process data is transmitted 1 : 1 according to its sequence.

Example for 64 PDO slots:

- $1440 - ((64 \text{ slots} * 2 \text{ bytes}) + 4 \text{ bytes}) = 1308$ bytes of user data

Example for 244 slots:

- $1440 - ((244 \text{ slots} * 2 \text{ bytes}) + 4 \text{ bytes}) = 948$ bytes of user data



9.3.4 Parameter data transfer

Data communication with PROFINET is characterised by the simultaneous operation of cyclic and acyclic services in the network. As an optional extension, the parameter data transfer belongs to the acyclic services, which provides access to all device parameters.

- The access to the device data depends on the PROFIdrive profile.
- There is always only one parameter request in process (no pipelining).
- No spontaneous messages are transferred.
- There are only acyclic parameter requests.

In principle, a IO-Controller can always be used to request parameters from the IO-Device if the IO-Device is in the DATA_EXCHANGE state.

Transmission directions for acyclic data transfer

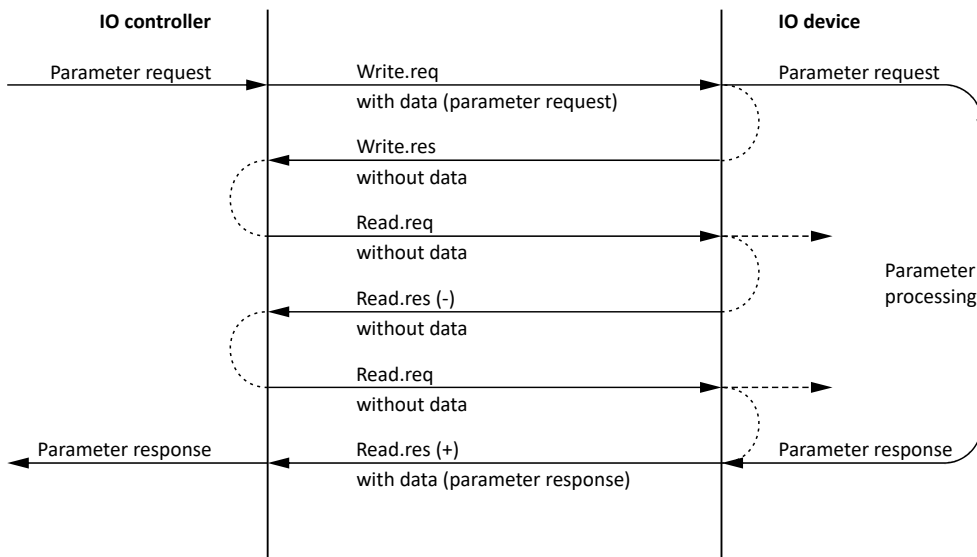

1. A "Write.req" is used to transmit the data set (DB47) as parameter request to the IO-Device.
2. "Write.res" is used to confirm to IO-Controller that the message was received.
3. The IO-Controller uses "Read.req" to request the response of the IO-Device.
4. The IO-Device responds with a "Read.res (-)" if processing is not yet completed.
5. After parameter processing, the parameter request is completed by using "Read.res (+)" to transmit the parameter response to the IO-Controller.

Telegram structure

Destr	ScrAddr	VLAN	Type 0x0800	RPC	NDR	Read/Write Block	Data	FCS
6 bytes	6 bytes	4 bytes	4 bytes	80 bytes	64 bytes	64 bytes	0 240 bytes	4 bytes

The initiator specifies the access to the "DB47" data set in the "Read/Write Block" field. The data written to this index or read from it contains a header and the parameter request or the parameter response. The read data or the data to be written is contained in the "Data" field.

Configuring the network

PROFINET IO-Device
Monitoring



Assignment of the user data depending on the data type

Depending on the data type used, the user data is assigned as follows:

Data type	Length	User data assignment				
		Byte 1	Byte 2	Byte 3	Byte 4	Byte ...
String	x bytes	Data (x bytes)				
U8	1 byte	Data	0x00			
U16	2 bytes	High byte	Low byte			
		Data	Data			
U32	4 bytes	High word		Low word		
		High byte	Low byte	High byte	Low byte	
		Data	Data	Data	Data	

9.3.5 Monitoring

The parameters for setting network monitoring functions are described below.

Parameter

Address	Name / setting range / [default setting]	Information
0x2859:001	PROFINET monitoring: Watchdog elapsed	Selection of the response to a permanent interruption of the communication to the IO controller. Corresponding error code: 33168 0x8190 "PROFINET: Watchdog time-out" Associated event ID: • 822313360 0x31038190 - Network - Watchdog time-out
	0 No response	
	1 Warning	
	2 Trouble	
	3 Fault	
0x2859:002	PROFINET monitoring: Data exchange exited	Selection of the response to exiting the "Data Exchange" state. Associated event ID: • 822313361 0x31038191 - Network - Disruption of cyclic data exchange
	0 No response	
	1 Warning	
	2 Trouble	
	3 Fault	
0x2859:003	PROFINET monitoring: Invalid configuration	Selection of the response triggered by the reception of invalid configuration data. Associated event ID: • 822313607 0x31038287 - Network - Invalid configuration
	0 No response	
	1 Warning	
	2 Trouble	
	3 Fault	
0x2859:004	PROFINET monitoring: Initialisation error	Selection of the response triggered by the occurrence of an error during the initialisation of the network component. Associated event ID: • 822313362 0x31038192 - Network - Initialization error
	0 No response	
	1 Warning	
	2 Trouble	
	3 Fault	





Address	Name / setting range / [default setting]	Information
0x2859:005	PROFINET monitoring: Invalid process data	Process data marked as invalid (IOPS is "BAD") are received by the IO Controller. Typically in case of <ul style="list-style-type: none"> a PLC in STOP state, alarms, acyclic demand data. Selection of the response triggered by the reception of invalid process data. Associated event ID: <ul style="list-style-type: none"> 822313363 0x31038193 - Network - Invalid cyclic process data
	0 No response	
	1 Warning	
	2 Trouble	
	3 Fault	



9.3.6 Diagnostics

9.3.6.1 Status LEDs

Notes on the connection status with IO-Controller can be obtained via the LEDs "BUS RDY" and "BUS ERR" of the PROFINET option (front of the device).

In addition, the LEDs "L/A" at the RJ45 sockets indicate the connection status to the network.

"BUS RDY" LED (green)	State	Meaning
Off	Not connected	No connection to the IO-Controller
 Blinking	Connected	IO-Controller in STOP
 On	Data exchange	IO-Controller in RUN (DATA_EXCHANGE)

"BUS ERR" LED (red)	State	Meaning
Off	No fault	No fault
 Blinking fast	IO-Device identifies (localises)	The PROFINET function "node flashing test" is triggered by IO-Controller. The flickering LED serves to identify (locate) an accessible IO-Device.
 Blinking	Impermissible settings	Impermissible settings: Stack, station name or IP parameters are invalid.
 On (red)	Fault	Communication error (e. g. Ethernet cable removed)

LED "L" (Link, green)	Status	Meaning
Off	Not connected	No connection to the network
 On	Connected	A physical connection to the network is available

LED "A" (Activity, yellow)	Status	Meaning
 On or flickers	Traffic	Data is exchanged via the network

9.3.6.2 PROFINET IO-Device diagnostics

The following parameters show information on the network.

Parameter

Address	Name / setting range / [default setting]	Information
0x2382:001	Active PROFINET settings: IP address • Read only	Display of the active IP address.
0x2382:002	Active PROFINET settings: Subnet • Read only	Display of the active subnet mask.
0x2382:003	Active PROFINET settings: Gateway • Read only	Display of the gateway address.

Configuring the network

PROFINET IO-Device
Diagnostics
PROFINET IO-Device diagnostics



Address	Name / setting range / [default setting]	Information	
0x2382:004	Active PROFINET settings: Station name • Read only	Display of the active station name.	
0x2382:005	Active PROFINET settings: MAC Address • Read only	Display of the active MAC address.	
0x2388	PROFINET status • Read only	Bit coded display of the current Bus status.	
	Bit 0	Initialized	
	Bit 1	Online	
	Bit 2	Connected	
	Bit 3	IP address error	The IP address is invalid. Valid IP addresses are defined according to RFC 3330.
	Bit 4	Hardware fault	
	Bit 5	Reserved	
	Bit 6	Watchdog elapsed	
	Bit 7	Protocol error	
	Bit 8	PROFINET stack ok	
	Bit 9	PROFINET stack not configured	
	Bit 10	Ethernet controller fault	
Bit 11	UDP stack fault		
0x2389:001	PROFINET error: Error 1 • Read only	The parameter currently contains the error detected on the network. • The error values may occur in combination with the error values from parameter 0x2389:002 .	
	0	No error	
	2	Unit ID unknown	
	3	Max. units exceeded	
	4	Invalid size	
	5	Unit type unknown	
	6	Runtime plug error	
	7	Invalid argument	
	8	Service pending	
	9	Stack not ready	
	10	Command unknown	
	11	Invalid address descriptor	
0x2389:002	PROFINET error: Error 2 • Read only	The parameter currently contains the error detected on the network. • The error values may occur in combination with the error values from parameter 0x2389:001 .	
	Bit 7	IP address error	The IP address is invalid. Valid IP addresses are defined according to RFC 3330.
	Bit 8	Station name problem	The station name must be assigned according to the PROFINET specification.
	Bit 9	DataExch left	PROFINET communication is continuously interrupted in the "Data_Exchange" state, e. g. by cable break. • PROFINET communication changes to the "No_Data_Exchange" state. • When the watchdog monitoring time specified by the IO Controller has elapsed, the response set in 0x2859:001 is triggered in the device.
	Bit 10	Stack boot error	
	Bit 11	Stack online error	
	Bit 12	Stack state error	
	Bit 13	Stack revision error	
Bit 14	Initialization problem	The stack cannot be initiated with the user specifications. A reason might be, e. g., a station name that does not correspond to the PROFINET specification.	
Bit 15	Stack init error		



10 Configuring the firewall

The firewall integrated in the controller can be used to restrict communication with the surrounding network.



The firewall is deactivated by default!

You can activate and configure the firewall using the "PLC Designer".
(Device tab → Settings → Communication → Firewall)

Configuring the firewall



Parameter

Address	Name / setting range / [default setting]	Information
0x5901:001	Security setting HAProxy: Certificate fingerprint • Read only	Display of the fingerprint (digital fingerprint) of the certificate for http/wss communication.
0x5901:002	Security setting HAProxy: HTTPS redirect • Read only	Display whether the visualization content of "EASY UI Designer" is redirected from HTTP to HTTPS or whether this setting is deactivated.
	0 For EASY UI disabled	No redirection from HTTP to HTTPS. HTTP and HTTPS requests for visualization content ("EASY UI Designer") are answered directly.
	1 For EASY UI enabled	HTTP requests for visualization content ("EASY UI Designer") are redirected. The website visitor is requested to use an HTTPS connection.
	2 For EASY UI changing	Status feedback that the redirection from HTTP to HTTPS for visualization content has been changed.
	3 HAProxy not active - No access	Status feedback that the redirection from HTTP to HTTPS for visualization content has not been changed because the HAProxy is not active.
	255 Not valid	
0x5910:001	Firewall: Activation	Activate or deactivate the firewall.
	0 Deactivated	
	1 Activated	
0x5910:002	Firewall: IP range 1 start 0 ... [0] ... 4294967295	Setting of IP range 1 for permitted client IP addresses. The IP range defined here can be selected in the firewall settings for the various ports.
0x5910:003	Firewall: IP range 1 end 0 ... [0] ... 4294967295	Setting of IP range 1 for permitted client IP addresses. The IP range defined here can be selected in the firewall settings for the various ports. End of IP range 1 for permitted client IP addresses.
0x5910:004	Firewall: IP range 2 start 0 ... [0] ... 4294967295	Setting of IP range 2 for permitted client IP addresses. The IP range defined here can be selected in the firewall settings for the various ports.
0x5910:005	Firewall: IP range 2 end 0 ... [0] ... 4294967295	Setting of IP range 2 for permitted client IP addresses. The IP range defined here can be selected in the firewall settings for the various ports. End of IP range 2 for permitted client IP addresses.
0x5910:006	Firewall: IP range 3 start 0 ... [0] ... 4294967295	Setting of IP range 3 for permitted client IP addresses. The IP range defined here can be selected in the firewall settings for the various ports.
0x5910:007	Firewall: IP range 3 end 0 ... [0] ... 4294967295	Setting of IP range 3 for permitted client IP addresses. The IP range defined here can be selected in the firewall settings for the various ports. End of IP range 3 for permitted client IP addresses.
0x5910:008	Firewall: IP range 4 start 0 ... [0] ... 4294967295	Setting of IP range 4 for permitted client IP addresses. The IP range defined here can be selected in the firewall settings for the various ports.
0x5910:009	Firewall: IP range 4 end 0 ... [0] ... 4294967295	Setting of IP range 4 for permitted client IP addresses. The IP range defined here can be selected in the firewall settings for the various ports. End of IP range 4 for permitted client IP addresses.
0x5911:001	Well-known ports: Secure Shell (SSH): Network 0 ... [0] ... 255	Network setting for the firewall to the "Secure Shell (SSH)" port. • SSH enables a secure, authenticated and encrypted connection between two computers via an insecure network.
	Bit 0 Engineering port	Setting for diagnostic interface X16 for a connection to the "EASY Starter". The "EASY Starter" can be used as a diagnostic tool and for commissioning.
	Bit 1 Fieldbus slave	
0x5911:002	Well-known ports: Secure Shell (SSH): Client IP range	Client IP range for the firewall to the "Secure Shell (SSH)" port.
	0 Any	All client IP addresses are permitted.
	1 IP range 1	Only clients in the IP range 1 (0x5910:002 ... 0x5910:003) are permitted.
	2 IP range 2	Only clients in the IP range 2 (0x5910:004 ... 0x5910:005) are permitted.
	3 IP range 3	Only clients in the IP range 3 (0x5910:006 ... 0x5910:007) are permitted.
	4 IP range 4	Only clients in the IP range 4 (0x5910:008 ... 0x5910:009) are permitted.
0x5911:003	Well-known ports: Secure Shell (SSH): Activation	Action for the firewall to the "Secure Shell (SSH)" port.
	0 Drop	Reject the connection, do NOT notify the sender.
	1 Reject	Reject the connection, notify the sender.
	2 Allow	Allow connection.



Configuring the firewall

Address	Name / setting range / [default setting]	Information
0x5911:031	Well-known ports: Network Time Protocol (NTP): Network 0 ... [0] ... 255	Network setting for the firewall for the "Network Time Protocol (NTP)" port. <ul style="list-style-type: none"> NTP functions as a time stamp during transmission and synchronizes the times of different systems down to the nanosecond.
	Bit 0 Engineering port	Setting for diagnostic interface X16 for a connection to the "EASY Starter". The "EASY Starter" can be used as a diagnostic tool and for commissioning.
	Bit 1 Fieldbus slave	
0x5911:032	Well-known ports: Network Time Protocol (NTP): Client IP range	Client IP range for the firewall to the "Network Time Protocol (NTP)" port.
	0 Any	All client IP addresses are permitted.
	1 IP range 1	Only clients in the IP range 1 (0x5910:002 ... 0x5910:003) are permitted.
	2 IP range 2	Only clients in the IP range 2 (0x5910:004 ... 0x5910:005) are permitted.
	3 IP range 3	Only clients in the IP range 3 (0x5910:006 ... 0x5910:007) are permitted.
0x5911:033	Well-known ports: Network Time Protocol (NTP): Activation	Action for the firewall for the "Network Time Protocol (NTP)" port.
	0 Drop	Reject the connection, do NOT notify the sender.
	1 Reject	Reject the connection, notify the sender.
	2 Allow	Allow connection.
0x5911:051	Well-known ports: Hypertext Transfer Protocol Secure (HTTPS): Network 0 ... [0] ... 255	Network setting for the firewall for the "Hypertext Transfer Protocol Secure (HTTPS)" port. <ul style="list-style-type: none"> HTTPS is used to establish confidentiality and integrity in communication between the web server and web browser (client) on the World Wide Web. This is achieved through encryption and authentication, among others.
	Bit 0 Engineering port	Setting for diagnostic interface X16 for a connection to the "EASY Starter". The "EASY Starter" can be used as a diagnostic tool and for commissioning.
	Bit 1 Fieldbus slave	
0x5911:052	Well-known ports: Hypertext Transfer Protocol Secure (HTTPS): Client IP range	Client IP range for the firewall to the "Hypertext Transfer Protocol Secure (HTTPS)" port.
	0 Any	All client IP addresses are permitted.
	1 IP range 1	Only clients in the IP range 1 (0x5910:002 ... 0x5910:003) are permitted.
	2 IP range 2	Only clients in the IP range 2 (0x5910:004 ... 0x5910:005) are permitted.
	3 IP range 3	Only clients in the IP range 3 (0x5910:006 ... 0x5910:007) are permitted.
0x5911:053	Well-known ports: Hypertext Transfer Protocol Secure (HTTPS): Activation	Action for the firewall for the "Hypertext Transfer Protocol Secure (HTTPS)" port.
	0 Drop	Reject the connection, do NOT notify the sender.
	1 Reject	Reject the connection, notify the sender.
	2 Allow	Allow connection.
0x5912:001	Registered ports: PLC Designer TCP gateway search: Network 0 ... [0] ... 255	Network setting for the firewall for the "PLC Designer TCP gateway search" port.
	Bit 0 Engineering port	Setting for diagnostic interface X16 for a connection to the "EASY Starter". The "EASY Starter" can be used as a diagnostic tool and for commissioning.
	Bit 1 Fieldbus slave	
0x5912:002	Registered ports: PLC Designer TCP gateway search: Client IP range	Client IP range for the firewall to the port "PLC Designer TCP gateway search".
	0 Any	All client IP addresses are permitted.
	1 IP range 1	Only clients in the IP range 1 (0x5910:002 ... 0x5910:003) are permitted.
	2 IP range 2	Only clients in the IP range 2 (0x5910:004 ... 0x5910:005) are permitted.
	3 IP range 3	Only clients in the IP range 3 (0x5910:006 ... 0x5910:007) are permitted.
4 IP range 4	Only clients in the IP range 4 (0x5910:008 ... 0x5910:009) are permitted.	

Configuring the firewall



Address	Name / setting range / [default setting]	Information
0x5912:003	Registered ports: PLC Designer TCP gateway search: Activation	Action for the firewall for the port "PLC Designer TCP gateway search".
	0 Drop	Reject the connection, do NOT notify the sender.
	1 Reject	Reject the connection, notify the sender.
	2 Allow	Allow connection.
0x5912:011	Registered ports: PLC Designer UDP communication: Network 0 ... [0] ... 255	Network setting for the firewall for the "PLC Designer UDP communication" port. <ul style="list-style-type: none">The User Datagram Protocol (UDP) is a minimal, connectionless network protocol that belongs to the transport layer of the Internet protocol family.
	Bit 0 Engineering port	Setting for diagnostic interface X16 for a connection to the "EASY Starter". The "EASY Starter" can be used as a diagnostic tool and for commissioning.
	Bit 1 Fieldbus slave	
0x5912:012	Registered ports: PLC Designer UDP communication: Client IP range	Client IP range for the firewall to the "PLC Designer UDP communication" port.
	0 Any	All client IP addresses are permitted.
	1 IP range 1	Only clients in the IP range 1 (0x5910:002 ... 0x5910:003) are permitted.
	2 IP range 2	Only clients in the IP range 2 (0x5910:004 ... 0x5910:005) are permitted.
	3 IP range 3	Only clients in the IP range 3 (0x5910:006 ... 0x5910:007) are permitted.
0x5912:013	Registered ports: PLC Designer UDP communication: Activation	Action for the firewall for the "PLC Designer UDP communication" port.
	0 Drop	Reject the connection, do NOT notify the sender.
	1 Reject	Reject the connection, notify the sender.
	2 Allow	Allow connection.
0x5912:031	Registered ports: Lenze specific device-search (ESDCP): Network 0 ... [0] ... 255	Network setting for the firewall for the port "Lenze-specific device search (ESDCP)".
	Bit 0 Engineering port	Setting for diagnostic interface X16 for a connection to the "EASY Starter". The "EASY Starter" can be used as a diagnostic tool and for commissioning.
	Bit 1 Fieldbus slave	
0x5912:032	Registered ports: Lenze specific device-search (ESDCP): Client IP range	Client IP range for the firewall for the port "Lenze-specific device search (ESDCP)".
	0 Any	All client IP addresses are permitted.
	1 IP range 1	Only clients in the IP range 1 (0x5910:002 ... 0x5910:003) are permitted.
	2 IP range 2	Only clients in the IP range 2 (0x5910:004 ... 0x5910:005) are permitted.
	3 IP range 3	Only clients in the IP range 3 (0x5910:006 ... 0x5910:007) are permitted.
0x5912:033	Registered ports: Lenze specific device-search (ESDCP): Activation	Action for the firewall for the port "Lenze-specific device search (ESDCP)".
	0 Drop	Reject the connection, do NOT notify the sender.
	1 Reject	Reject the connection, notify the sender.
	2 Allow	Allow connection.
0x5912:041	Registered ports: OPC UA server: Network 0 ... [0] ... 255	Network setting for the firewall to the "OPC UA Server" port. <ul style="list-style-type: none">OPC UA (Open Platform Communications Unified Architecture) is a collection of standards for communication and data exchange in the field of industrial automation.
	Bit 0 Engineering port	Setting for diagnostic interface X16 for a connection to the "EASY Starter". The "EASY Starter" can be used as a diagnostic tool and for commissioning.
	Bit 1 Fieldbus slave	
0x5912:042	Registered ports: OPC UA server: Client IP range	Client IP range for the firewall to the "OPC UA Server" port.
	0 Any	All client IP addresses are permitted.
	1 IP range 1	Only clients in the IP range 1 (0x5910:002 ... 0x5910:003) are permitted.
	2 IP range 2	Only clients in the IP range 2 (0x5910:004 ... 0x5910:005) are permitted.
	3 IP range 3	Only clients in the IP range 3 (0x5910:006 ... 0x5910:007) are permitted.
4 IP range 4	Only clients in the IP range 4 (0x5910:008 ... 0x5910:009) are permitted.	



Configuring the firewall

Address	Name / setting range / [default setting]	Information
0x5912:043	Registered ports: OPC UA server: Activation	Action for the firewall to the "OPC UA Server" port.
	0 Drop	Reject the connection, do NOT notify the sender.
	1 Reject	Reject the connection, notify the sender.
	2 Allow	Allow connection.
0x5912:051	Registered ports: EtherCAT master diagnostic tool: Network 0 ... [0] ... 255	Network setting for the firewall to the "EtherCAT master diagnostics tool" port.
	Bit 0 Engineering port	Setting for diagnostic interface X16 for a connection to the "EASY Starter". The "EASY Starter" can be used as a diagnostic tool and for commissioning.
	Bit 1 Fieldbus slave	
0x5912:052	Registered ports: EtherCAT master diagnostic tool: Client IP range	Client IP range for the firewall to the "EtherCAT master diagnostics tool" port.
	0 Any	All client IP addresses are permitted.
	1 IP range 1	Only clients in the IP range 1 (0x5910:002 ... 0x5910:003) are permitted.
	2 IP range 2	Only clients in the IP range 2 (0x5910:004 ... 0x5910:005) are permitted.
	3 IP range 3	Only clients in the IP range 3 (0x5910:006 ... 0x5910:007) are permitted.
	4 IP range 4	Only clients in the IP range 4 (0x5910:008 ... 0x5910:009) are permitted.
0x5912:053	Registered ports: EtherCAT master diagnostic tool: Activation	Action for the firewall to the "EtherCAT master diagnostics tool" port.
	0 Drop	Reject the connection, do NOT notify the sender.
	1 Reject	Reject the connection, notify the sender.
	2 Allow	Allow connection.
0x5912:061	Registered ports: UI designer RAW: Network 0 ... [0] ... 255	Network setting for the firewall for the "UI Designer RAW" port.
	Bit 0 Engineering port	Setting for diagnostic interface X16 for a connection to the "EASY Starter". The "EASY Starter" can be used as a diagnostic tool and for commissioning.
	Bit 1 Fieldbus slave	
0x5912:062	Registered ports: UI designer RAW: Client IP range	Client IP range for the firewall to the "UI Designer RAW" port.
	0 Any	All client IP addresses are permitted.
	1 IP range 1	Only clients in the IP range 1 (0x5910:002 ... 0x5910:003) are permitted.
	2 IP range 2	Only clients in the IP range 2 (0x5910:004 ... 0x5910:005) are permitted.
	3 IP range 3	Only clients in the IP range 3 (0x5910:006 ... 0x5910:007) are permitted.
	4 IP range 4	Only clients in the IP range 4 (0x5910:008 ... 0x5910:009) are permitted.
0x5912:063	Registered ports: UI designer RAW: Activation	Action for the firewall for the "UI Designer RAW" port.
	0 Drop	Reject the connection, do NOT notify the sender.
	1 Reject	Reject the connection, notify the sender.
	2 Allow	Allow connection.
0x5912:071	Registered ports: UI designer secure RAW: Network 0 ... [0] ... 255	Network setting for the firewall for the "UI Designer secure-RAW" port.
	Bit 0 Engineering port	Setting for diagnostic interface X16 for a connection to the "EASY Starter". The "EASY Starter" can be used as a diagnostic tool and for commissioning.
	Bit 1 Fieldbus slave	
0x5912:072	Registered ports: UI designer secure RAW: Client IP range	Client IP range for the firewall to the "UI Designer secure-RAW" port.
	0 Any	All client IP addresses are permitted.
	1 IP range 1	Only clients in the IP range 1 (0x5910:002 ... 0x5910:003) are permitted.
	2 IP range 2	Only clients in the IP range 2 (0x5910:004 ... 0x5910:005) are permitted.
	3 IP range 3	Only clients in the IP range 3 (0x5910:006 ... 0x5910:007) are permitted.
	4 IP range 4	Only clients in the IP range 4 (0x5910:008 ... 0x5910:009) are permitted.
0x5912:073	Registered ports: UI designer secure RAW: Activation	Action for the firewall for the "UI Designer secure-RAW" port.
	0 Drop	Reject the connection, do NOT notify the sender.
	1 Reject	Reject the connection, notify the sender.
	2 Allow	Allow connection.

Configuring the firewall



Address	Name / setting range / [default setting]	Information
0x5912:091	Registered ports: PLC Designer gateway: Network 0 ... [0] ... 255	Network setting for the firewall for the "PLC Designer Gateway" port.
	Bit 0 Engineering port	Setting for diagnostic interface X16 for a connection to the "EASY Starter". The "EASY Starter" can be used as a diagnostic tool and for commissioning.
	Bit 1 Fieldbus slave	
0x5912:092	Registered ports: PLC Designer gateway: Client IP range	Client IP range for the firewall to the "PLC Designer Gateway" port.
	0 Any	All client IP addresses are permitted.
	1 IP range 1	Only clients in the IP range 1 (0x5910:002 ... 0x5910:003) are permitted.
	2 IP range 2	Only clients in the IP range 2 (0x5910:004 ... 0x5910:005) are permitted.
	3 IP range 3	Only clients in the IP range 3 (0x5910:006 ... 0x5910:007) are permitted.
	4 IP range 4	Only clients in the IP range 4 (0x5910:008 ... 0x5910:009) are permitted.
0x5912:093	Registered ports: PLC Designer gateway: Activation	Action for the firewall for the "PLC Designer Gateway" port.
	0 Drop	Reject the connection, do NOT notify the sender.
	1 Reject	Reject the connection, notify the sender.
	2 Allow	Allow connection.
0x5912:101	Registered ports: Lenze specific engineering access (SFTP/SCP): Network 0 ... [0] ... 255	Network setting for the firewall for the port "Lenze-specific engineering access (SFTP/SCP)".
	Bit 0 Engineering port	Setting for diagnostic interface X16 for a connection to the "EASY Starter". The "EASY Starter" can be used as a diagnostic tool and for commissioning.
	Bit 1 Fieldbus slave	
0x5912:102	Registered ports: Lenze specific engineering access (SFTP/SCP): Client IP range	Client IP range for the firewall to the port "Lenze-specific engineering access (SFTP/SCP)".
	0 Any	All client IP addresses are permitted.
	1 IP range 1	Only clients in the IP range 1 (0x5910:002 ... 0x5910:003) are permitted.
	2 IP range 2	Only clients in the IP range 2 (0x5910:004 ... 0x5910:005) are permitted.
	3 IP range 3	Only clients in the IP range 3 (0x5910:006 ... 0x5910:007) are permitted.
	4 IP range 4	Only clients in the IP range 4 (0x5910:008 ... 0x5910:009) are permitted.
0x5912:103	Registered ports: Lenze specific engineering access (SFTP/SCP): Activation	Action for the firewall for the port "Lenze-specific engineering access (SFTP/SCP)".
	0 Drop	Reject the connection, do NOT notify the sender.
	1 Reject	Reject the connection, notify the sender.
	2 Allow	Allow connection.
0x5912:131	Registered ports: SFTP/SCP: Network 0 ... [0] ... 255	Network setting for the firewall for the "SFTP/SCP" port.
	Bit 0 Engineering port	Setting for diagnostic interface X16 for a connection to the "EASY Starter". The "EASY Starter" can be used as a diagnostic tool and for commissioning.
	Bit 1 Fieldbus slave	
0x5912:132	Registered ports: SFTP/SCP: Client IP range	Client IP range for the firewall to the "SFTP/SCP" port.
	0 Any	All client IP addresses are permitted.
	1 IP range 1	Only clients in the IP range 1 (0x5910:002 ... 0x5910:003) are permitted.
	2 IP range 2	Only clients in the IP range 2 (0x5910:004 ... 0x5910:005) are permitted.
	3 IP range 3	Only clients in the IP range 3 (0x5910:006 ... 0x5910:007) are permitted.
	4 IP range 4	Only clients in the IP range 4 (0x5910:008 ... 0x5910:009) are permitted.
0x5912:133	Registered ports: SFTP/SCP: Activation	Action for the firewall for the "SFTP/SCP" port.
	0 Drop	Reject the connection, do NOT notify the sender.
	1 Reject	Reject the connection, notify the sender.
	2 Allow	Allow connection.
0x5912:151	Registered ports: OPC UA PubSub (UADP): Network 0 ... [0] ... 255	Network setting for the firewall for the "OPC UA PubSub (UADP)" port.
	Bit 0 Engineering port	Setting for diagnostic interface X16 for a connection to the "EASY Starter". The "EASY Starter" can be used as a diagnostic tool and for commissioning.
	Bit 1 Fieldbus slave	



Address	Name / setting range / [default setting]	Information
0x5912:152	Registered ports: OPC UA PubSub (UADP): Client IP Range	Client IP range for the firewall to the "OPC UA PubSub (UADP)" port.
	0 Any	All client IP addresses are permitted.
	1 IP range 1	Only clients in the IP range 1 (0x5910:002 ... 0x5910:003) are permitted.
	2 IP range 2	Only clients in the IP range 2 (0x5910:004 ... 0x5910:005) are permitted.
	3 IP range 3	Only clients in the IP range 3 (0x5910:006 ... 0x5910:007) are permitted.
0x5912:153	Registered ports: OPC UA PubSub (UADP): Activation • Read only	Action for the firewall for the "OPC UA PubSub (UADP)" port.
	0 Drop	Reject the connection, do NOT notify the sender.
	1 Reject	Reject the connection, notify the sender.
	2 Allow	Allow connection.
0x5913:001	Application ports: Application port 1: Network 0 ... [0] ... 255	Network setting for firewall to application port 1.
	Bit 0 Engineering port	Setting for diagnostic interface X16 for a connection to the "EASY Starter". The "EASY Starter" can be used as a diagnostic tool and for commissioning.
	Bit 1 Fieldbus slave	
0x5913:002	Application ports: Application port 1: Client IP range	Client IP range for the firewall to application port 1.
	0 Any	All client IP addresses are permitted.
	1 IP range 1	Only clients in the IP range 1 (0x5910:002 ... 0x5910:003) are permitted.
	2 IP range 2	Only clients in the IP range 2 (0x5910:004 ... 0x5910:005) are permitted.
	3 IP range 3	Only clients in the IP range 3 (0x5910:006 ... 0x5910:007) are permitted.
0x5913:003	Application ports: Application port 1: Activation	Action for the firewall to application port 1.
	0 Drop	Reject the connection, do NOT notify the sender.
	1 Reject	Reject the connection, notify the sender.
	2 Allow	Allow connection.
0x5913:007	Application ports: Application port 1: Protocol type	Permitted protocols for the firewall to application port 1.
	0 None	TCP and UDP protocols are blocked.
	1 TCP	Only TCP protocols are allowed, UDP protocols are blocked.
	2 UDP	Only UDP protocols are allowed, TCP protocols are blocked.
3 TCP & UDP	TCP and UDP protocols are permitted.	
0x5913:008	Application ports: Application port 1: Port range start 0 ... [0] ... 65535	Start of the port range used for application port 1.
0x5913:009	Application ports: Application port 1: Port range end 0 ... [0] ... 65535	End of the port range used for application port 1.
0x5913:010	Application ports: Application port 1: Protocol name ["0"]	Freely selectable name as a guide for programmers for application port 1. This name is for information purposes only and has no function.
0x5913:011	Application ports: Application port 2: Network 0 ... [0] ... 255	Network setting for the firewall to application port 2.
	Bit 0 Engineering port	Setting for diagnostic interface X16 for a connection to the "EASY Starter". The "EASY Starter" can be used as a diagnostic tool and for commissioning.
	Bit 1 Fieldbus slave	
0x5913:012	Application ports: Application port 2: Client IP range	Client IP range for the firewall to application port 2.
	0 Any	All client IP addresses are permitted.
	1 IP range 1	Only clients in the IP range 1 (0x5910:002 ... 0x5910:003) are permitted.
	2 IP range 2	Only clients in the IP range 2 (0x5910:004 ... 0x5910:005) are permitted.
	3 IP range 3	Only clients in the IP range 3 (0x5910:006 ... 0x5910:007) are permitted.
0x5913:013	Application ports: Application port 2: Activation	Action for the firewall to application port 2.
	0 Drop	Reject the connection, do NOT notify the sender.
	1 Reject	Reject the connection, notify the sender.
	2 Allow	Allow connection.

Configuring the firewall



Address	Name / setting range / [default setting]	Information
0x5913:017	Application ports: Application port 2: Protocol type	Permitted protocols for the firewall to application port 2.
	0 None	TCP and UDP protocols are blocked.
	1 TCP	Only TCP protocols are allowed, UDP protocols are blocked.
	2 UDP	Only UDP protocols are allowed, TCP protocols are blocked.
	3 TCP & UDP	TCP and UDP protocols are permitted.
0x5913:018	Application ports: Application port 2: Port range start 0 ... [0] ... 65535	Start of the port range used for application port 2.
0x5913:019	Application ports: Application port 2: Port range end 0 ... [0] ... 65535	End of the port range used for application port 2.
0x5913:020	Application ports: Application port 2: Protocol name ["0"]	Freely selectable name as a guide for programmers for application port 2. This name is for information purposes only and has no function.
0x5913:021	Application ports: Application port 3: Network 0 ... [0] ... 255	Network setting for the firewall to application port 3.
	Bit 0 Engineering port	Setting for diagnostic interface X16 for a connection to the "EASY Starter". The "EASY Starter" can be used as a diagnostic tool and for commissioning.
	Bit 1 Fieldbus slave	
0x5913:022	Application ports: Application port 3: Client IP range	Client IP range for the firewall to application port 3.
	0 Any	All client IP addresses are permitted.
	1 IP range 1	Only clients in the IP range 1 (0x5910:002 ... 0x5910:003) are permitted.
	2 IP range 2	Only clients in the IP range 2 (0x5910:004 ... 0x5910:005) are permitted.
	3 IP range 3	Only clients in the IP range 3 (0x5910:006 ... 0x5910:007) are permitted.
	4 IP range 4	Only clients in the IP range 4 (0x5910:008 ... 0x5910:009) are permitted.
0x5913:023	Application ports: Application port 3: Activation	Action for the firewall to application port 3.
	0 Drop	Reject the connection, do NOT notify the sender.
	1 Reject	Reject the connection, notify the sender.
	2 Allow	Allow connection.
0x5913:027	Application ports: Application port 3: Protocol type	Permitted protocols for the firewall to application port 3.
	0 None	TCP and UDP protocols are blocked.
	1 TCP	Only TCP protocols are allowed, UDP protocols are blocked.
	2 UDP	Only UDP protocols are allowed, TCP protocols are blocked.
	3 TCP & UDP	TCP and UDP protocols are permitted.
0x5913:028	Application ports: Application port 3: Port range start 0 ... [0] ... 65535	Start of the port range used for application port 3.
0x5913:029	Application ports: Application port 3: Port range end 0 ... [0] ... 65535	End of the port range used for application port 3.
0x5913:030	Application ports: Application port 3: Protocol name ["0"]	Freely selectable name as a guide for programmers for application port 3. This name is for information purposes only and has no function.
0x5913:031	Application ports: Application port 4: Network 0 ... [0] ... 255	Network setting for the firewall to application port 4.
	Bit 0 Engineering port	Setting for diagnostic interface X16 for a connection to the "EASY Starter". The "EASY Starter" can be used as a diagnostic tool and for commissioning.
	Bit 1 Fieldbus slave	
0x5913:032	Application ports: Application port 4: Client IP range	Client IP range for the firewall to application port 4.
	0 Any	All client IP addresses are permitted.
	1 IP range 1	Only clients in the IP range 1 (0x5910:002 ... 0x5910:003) are permitted.
	2 IP range 2	Only clients in the IP range 2 (0x5910:004 ... 0x5910:005) are permitted.
	3 IP range 3	Only clients in the IP range 3 (0x5910:006 ... 0x5910:007) are permitted.
	4 IP range 4	Only clients in the IP range 4 (0x5910:008 ... 0x5910:009) are permitted.
0x5913:033	Application ports: Application port 4: Activation	Action for the firewall to application port 4.
	0 Drop	Reject the connection, do NOT notify the sender.
	1 Reject	Reject the connection, notify the sender.
	2 Allow	Allow connection.



Configuring the firewall

Address	Name / setting range / [default setting]	Information
0x5913:037	Application ports: Application port 4: Protocol type	Permitted protocols for the firewall to application port 4.
	0 None	TCP and UDP protocols are blocked.
	1 TCP	Only TCP protocols are allowed, UDP protocols are blocked.
	2 UDP	Only UDP protocols are allowed, TCP protocols are blocked.
	3 TCP & UDP	TCP and UDP protocols are permitted.
0x5913:038	Application ports: Application port 4: Port range start 0 ... [0] ... 65535	Start of the port range used for application port 4.
0x5913:039	Application ports: Application port 4: Port range end 0 ... [0] ... 65535	End of the port range used for application port 4.
0x5913:040	Application ports: Application port 4: Protocol name ["0"]	Freely selectable name as a guide for programmers for application port 4. This name is for information purposes only and has no function.





11 Configuring OPC UA

OPC UA (Open Platform Communications Unified Architecture) is a globally recognized communication framework that is standardized by the IEC 62541 series of standards. It is currently the most promising standard for the implementation of Industry 4.0 communication, in which machine data can be exchanged regardless of manufacturer and platform.

OPC UA is represented as a standard by the OPC Foundation.

<https://opcfoundation.org/>

The following OPC UA functions/services are integrated in the controller:

- ▶ OPC UA server  127
- ▶ OPC UA client  129
- ▶ OPC UA PubSub  130



11.1 OPC UA server

The integrated OPC UA server can be used to publish PLC variables via OPC UA in accordance with IEC 61131. For example, visualization connections or MES, SCADA or cloud connections that require easy access to PLC variables can be implemented. It is also possible to map the PLC variables to user-specific information models that can be derived from Companion Specifications. In addition to variables, OPC UA methods and events can also be mapped to the PLC application.

11.1.1 Basic setting

Parameter

Address	Name / setting range / [default setting]	Information
0x2470:001	OPC UA server control: Restart server	Restart OPC UA server.
	0 No action/no error	Only status feedback
	1 Restart with current values	Execute device command
	10 In process	Only status feedback
	11 Action cancelled	
	12 Fault	
0x2471:013	OPC UA server settings: Min. publishing interval 100 ... [100] ... 10000 ms	Minimum possible publishing interval for notifications.
0x2471:014	OPC UA server settings: Min. sample interval 100 ... [100] ... 10000 ms	Minimum possible sampling interval of monitored items.
0x2471:051	OPC UA server settings: PLCopen model array expansion	Enable extended representation of IEC arrays in the OPC UA information model.
	0 Disabled	
	1 Enabled	
0x2471:103	OPC UA server settings: Max. number of external sessions 0 ... [1] ... 3	Maximum permitted number of external client connections.

11.1.2 Diagnostics

11.1.2.1 Active OPC UA server settings

Parameter

Address	Name / setting range / [default setting]	Information
0x2472:011	Active OPC UA server settings: Max. number of subscriptions • Read only	Display of the maximum possible number of subscriptions.
0x2472:012	Active OPC UA server settings: Max. number of monitored items • Read only	Display of the maximum possible number of monitored items.
0x2472:013	Active OPC UA server settings: Min. publishing interval • Read only	Display of the minimum possible publishing interval for notifications.
0x2472:014	Active OPC UA server settings: Min. sample interval • Read only	Display of the minimum possible sampling interval of monitored items.
0x2472:051	Active OPC UA server settings: PLCopen model array expansion • Read only	Display whether the extended representation of IEC arrays is activated in the OPC UA information model.
	0 Disabled	
	1 Enabled	

Configuring OPC UA

OPC UA server
Diagnostics
OPC UA server diagnostics



Address	Name / setting range / [default setting]	Information
0x2472:103	Active OPC UA server settings: Max. number of external sessions • Read only	Display of the maximum permitted number of external client connections.

11.1.2.2 OPC UA server diagnostics

Parameter

Address	Name / setting range / [default setting]	Information
0x2473:001	OPC UA server diagnosis: State • Read only	Display of the current status of the OPC UA server according to OPC UA specification Part 5.
	0 Running	
	1 Failed	
	2 No configuration	
	3 Suspended	
	4 Shutdown	
	5 Test	
	6 Communication fault	
7 Unknown		
0x2473:002	OPC UA server diagnosis: Error • Read only	Display of the current error status of the OPC UA server, which leads to a functional restriction.
0x2473:011	OPC UA server diagnosis: Used number of subscriptions • Read only	Display of the number of subscriptions currently in use.
0x2473:012	OPC UA server diagnosis: Used number of monitored items • Read only	Display of the currently used number of monitored items.
0x2473:052	OPC UA server diagnosis: PLCopen model resource utilization • Read only: x %	Display of the current resource utilization of the PLCopen information model.
0x2473:053	OPC UA server diagnosis: User model resource utilization • Read only: x %	Display of the current resource utilization of the user-specific information model.
0x2473:101	OPC UA server diagnosis: Used number of engineering sessions • Read only	Display of the number of Lenze Engineering Client sessions currently in use.
0x2473:102	OPC UA server diagnosis: Used number of system sessions • Read only	Display of the number of Lenze System Client sessions currently in use.
0x2473:103	OPC UA server diagnosis: Used number of external sessions • Read only	Display of the number of external client sessions currently in use.
0x2473:130	OPC UA server diagnosis: Client of external session 1 • Read only	Display of the application URI of the external client session.
0x2473:131	OPC UA server diagnosis: Client of external session 2 • Read only	
0x2473:132	OPC UA server diagnosis: Client of external session 3 • Read only	



11.2 OPC UA client

To establish a connection from the PLC application to external instances via OPC UA, the IEC library "L_IOCP_OPCUAClient" provides an OPC UA client according to PLCopen. This allows applications such as control to control or control to any external data source to be solved.

To implement the use cases, the client provides the following services and functions, among others:

- Secured communication
- Reading and writing of data
- Calling server methods

Configuring OPC UA

OPC UA PubSub
Basic setting



11.3 OPC UA PubSub

The "OPC UA PubSub" functionality is available for communication from controller to controller or from controller to several receivers. This makes it possible to communicate PLC data cyclically without a dedicated connection.

11.3.1 Basic setting

Parameter

Address	Name / setting range / [default setting]	Information
0x247B:001	OPC UA PubSub control: Activation	Activate or deactivate OPC UA PubSub.
	0 Disabled	
	1 Enabled	
0x247B:002	OPC UA PubSub control: Restart PubSub	Restart OPC UA PubSub..
	0 No action/no error	Only status feedback
	1 Restart with current values	Execute device command
	10 In process	Only status feedback
	11 Action cancelled	
	12 Fault	



12 Device functions

12.1 Device identification

The controller consists of various partial components. The current versions are visible in a set of parameters.

Parameter

Address	Name / setting range / [default setting]	Information
0x2000:001	Device data: Product code • Read only	Product code of the controller Example: "c55AE40RC10020007S"
0x2000:002	Device data: Serial number • Read only	Serial number of the controller Example: "0000000000000000XYZYZ"
0x2000:003	Device data: Production date • Read only	The date of manufacture and the time of the device, e.g.: "2019-08-01 00:00:00Z"
0x2000:004	Device data: CU firmware version • Read only	Firmware version of the controller Example: "01.00.01.00".
0x2000:006	Device data: CU bootloader version • Read only	Boot loader version of the controller
0x2000:020	Device data: CPU name • Read only	Version of the hardware driver
0x2002:006	Device module: CU serial number • Read only	Serial number of the CPU module Parameter not available in this device.
0x2002:010	Device module: Type communication module • Read only	Display of the type designation of the communication module.
0x2002:011	Device module: Serial number communication module • Read only	Display of the serial number of the communication module.
0x2002:012	Device module: Hardware version communication module • Read only	Display of the hardware version of the communication module.
0x2002:020	Device module: Driver version • Read only	CPU type identification



12.2 Optical device identification

For applications including several controllers it may be difficult to locate a device that has been connected online. The "Optical device identification" function serves to locate the controller by means of blinking LEDs.

Details

In order to start the visual tracking, set [0x2021:001](#) = "Start [1]".

After the start, both LEDs "RDY" and "ERR" on the front of the controller synchronously blink very fast.

"RDY" LED (blue)	"ERR" LED (red)	Status/meaning
<p>Both LEDs are blinking in a very rapidly synchronous mode</p>		"Visual tracking" function is active.

The blinking rate can be set in [0x2021:002](#).

Parameter

Address	Name / setting range / [default setting]	Information		
0x2021:001	Optical tracking: Start detection	1 = start optical device identification. <ul style="list-style-type: none"> After the start, the two LEDs "RDY" and "ERR" on the front of the controller are blinking with a blinking frequency of 20 Hz for the blinking duration set in 0x2021:002. The setting is then automatically reset to "0" again. If the function is reactivated within the blinking time set, the time is extended correspondingly. A manual reset to "0" makes it possible to stop the function prematurely. 		
	<table border="1"> <tr> <td style="text-align: center;">0</td> <td>Stop</td> </tr> <tr> <td style="text-align: center;">1</td> <td>Start</td> </tr> </table>		0	Stop
0	Stop			
1	Start			
0x2021:002	Optical tracking: Blinking duration 0 ... [5] ... 3600 s	Setting of the blinking duration for the visual tracking.		



12.3 Switch-off behavior

The controller has internal buffer capacitors to save data during the shutdown process. This memory function is initiated automatically if a voltage failure is detected.



Certain circuit sections, e.g. backplane bus supply and USB, are switched off directly in the event of voltage failure in order to maintain voltage for the internal saving process for a constant amount of time.

12.3.1 Retain variables and persistent variables

Retain variables

The controller automatically saves retain variables in the event of voltage failure. In this way, they remain available when operation resumes. Retain variables are reinitialized when devices are reset or a new PLC program is downloaded. The values are preserved in the event of an online change.

Example

The values of a drive system which can no longer be read out from the machine due to a voltage failure should be persistent. These values should also be persistent if the corresponding value only changes through the influence of the PLC.

Variable	Use case	Storage
Thermal sensor	Changes, requires a sensor system.	Not required
Position value	Available via absolute value encoder.	Not required
Number of parts in buffer storage	Should be persistent so the value is not lost in the event of a reset or program change.	Persistent
Position of a conveyor line	Position should remain stored. Homing takes place.	Retain

Example code

```

VAR RETAIN
remvar1: INT; (* 1. Remanent variable*)
END_VAR

```

Persistent variables

Persistent variables also remain stored in the event of a stop, restart, online change, or PLC program download.

Persistent variables are saved when the device is switched off. Persistent variables are reinitialized by executing "RESET origin".

How to create persistent variables:

Precondition

- Access to »PLC Designer«
1. Right-click on Application.
 2. Select New object.
 3. Click on Persistent variables.

Example code

```

VAR_GLOBAL PERSISTENT RETAIN
uiPerRetain : ARRAY[0..1000] OF UINT; (* Declaration of persistent variable*)
END_VAR

```



12.4 Reset controller

To reset the device, press the reset button. ▶ [Features](#) 16

How to carry out a restart:

1. Keep the reset button pressed for approx. 1 s.
The LEDs are off.

After the restart, the LED "RUN" is green.

How to carry out a hardware reset:

1. Keep the reset button pressed for approx. 5 s.
The LEDs are off.

After the hardware reset, the LED "RUN" is green.

How to perform a software reset:

1. Switch off controller.
2. Switch on controller.
The LED "RDY " is blinking blue slowly.
3. Press and hold the reset button immediately.
The "RDY" LED is blinking blue/yellow quickly.
4. After approx.15 s (the LED "ERR" is blinking red/yellow fast) the reset button can be released.

The software reset procedure has started. A restart is performed, during which the last active software is re-installed. The entire process takes approx. 5 min. After the software reset, the "RUN" LED lights up green.



Depending on the state of the device functions, no retain data is saved when the device is reset via the reset button.

Relevant parameters of other functions

Address	Name	Default setting	Setting range
0x2022:001	Device commands: Load default settings	Off / ready [0]	Selection list
0x2022:039	Device commands: Load TA default settings	Off / ready [0]	Selection list

Related topics

- ▶ [Reset parameters to default](#) 43



12.5 Back up and restore data

The PLC runtime system (firmware) and the project data on the SD card can be backed up on a USB stick and restored from it for the same controller type (e. g. c430, c520 or c550) if required.

General information on the storage media used

Internal memory:

- The Lenze controller is equipped with a non-volatile memory containing the PLC runtime system (firmware).
- The PLC runtime system (firmware) can be backed up on a USB stick with the device command "Backup".

SD card:

- The SD card is used to store project data in the Lenze controller.
- The entire SD card is backed up, except for the "Firmware" and "License" directories. The remaining project data on the SD card must not exceed the max. memory size of 165 MB.
- The device command "Backup" is used to save not only the firmware but also the project data on the USB stick.

USB stick:

- The USB stick is the central storage medium for data backups.
- With the device command "Restore" and a previously created data backup, firmware and project data can be restored from the USB stick.
- If necessary, the controller's firmware can also be updated via USB stick [► Update firmware](#) [140](#)



Only use suitable USB sticks for the controller!

Due to their shape, some USB sticks may not be inserted deep enough into the USB socket of the controller. This can cause problems that do not always suggest the USB stick as the cause.

Directory structure of the USB stick:

Directory	Information
<USB-Stick>\firmware	The "firmware" directory is reserved for data backups.
<USB-Stick>\firmware \active\	This subdirectory contains the firmware of the controller after a data backup. <ul style="list-style-type: none"> • The "active" subdirectory may contain max. one firmware file. • This subdirectory is also used for updating the firmware ► Update firmware 140
<USB-Stick>\firmware \archive__\	This subdirectory is used for archiving older firmware versions and data backups.

Structure of the file names

File	Syntax	Example
Firmware file	<Controller family>_<Version>_<Type>.tar	c5xx_v_1.4.0.1342_firmware.tar
Data backup	<Type>_<Controller>_<Version>_<Date>_<Time>	backup_c550_v1_4_0_1359_20201208_0815.tar.gz

Device functions

Back up and restore data
Back up data



12.5.1 Back up data

This function saves the PLC runtime system (firmware) of the controller and additionally the project data on the SD card to a USB stick.



Do not switch off the device during data backup and do not remove the USB stick from the device! Observe the status display of the yellow LED "STA". [▶ Status LEDs](#) [147](#)

Preconditions:

- USB stick with at least 365 MB free memory
- The entire SD card is backed up, except for the "Firmware" and "License" directories. The remaining project data on the SD card must not exceed the max. memory size of 165 MB.

How to save PLC runtime system (firmware) and project data on a USB stick:

1. Insert the USB stick into the port of the controller from which a data backup is to be created (USB port 1 **X61** or USB port 2 **X62**).
2. Execute the "Backup" device command, e. g. with »PLC Designer«: Set **0x2022:040** to "1: On / Start".

The data backup progress is shown in **0x2022:040**. After the process is completed, the status "0: Off / Ready" is displayed in **0x2022:040**.

3. Remove the USB stick.

PLC runtime system (firmware) and project data are now saved on the USB stick.



Parameter

Address	Name / setting range / [default setting]	Information	
0x2022:040	Device commands: Parameter-Backup	<ul style="list-style-type: none"> Setting can only be changed if application status (displayed in 0x5810:001) is not equal to "1: Running". When the device command has been executed successfully, the value 0 is shown. Do not switch off the power supply and do not remove the USB stick and SD card from the controller while the data backup is running! 	
	<ul style="list-style-type: none"> Settings can only be changed if the PLC application is not in the "Running" status. 		
	0 Off / ready		Only status feedback
	1 On / start		Execute device command
	2 In progress		Only status feedback
	3 Action cancelled		
	4 No access		
	5 No access (Device disabled)		
	20 20%		
	40 40%		
	60 60%		
	80 80%		
	100 100%		
	101 No SD card connected		
	102 SD card is write protected		
	103 SD card is full		
	104 USB stick not mounted		
	105 Backup file on USB stick wrong, double or in the wrong path		
	106 USB stick is full		
	107 Device no memory space left		
108 Firmware size too large			
109 User data size too large			
110 Up/Downgrade successful - remove USB stick and restart the device			
111 Application is still running - stop application first			
112 Other device command active - wait for end of execution			
113 Error - see Logbook for details			



12.5.2 Restore data

This function allows you to restore the PLC runtime system (firmware) and the project data. Data recovery can be carried out either by power switching the controller or via a device parameter.



You can also restore an older data backup. To do this, copy the corresponding data backup on the USB stick from the "firmware\archive__" to "firmware\active" directory. However, the directory "firmware\active" may only contain one file at a time.



Do not switch off the device during data backup and do not remove the USB stick from the device! Note the status display of the yellow "STA" LED. ▶ [Status LEDs](#)  147

Data recovery via power switching

Preconditions

- USB stick with valid data backup of the same controller type.

How to perform a data recovery using power switching:

1. Insert the USB stick into the port of the controller from which a data recovery is to be performed (USB port 1 **X61** or USB port 2 **X62**).
2. Restart the controller by power switching to start the restore process.
3. Remove the USB stick when the loading process is completed.
4. Restart the controller.

Data recovery via power switching is completed.

Data recovery using device parameters

Preconditions

- USB stick with valid data backup of the same controller type.

How to perform data recovery using device parameters:

1. Insert the USB stick into the port of the controller from which the data recovery is to be performed (USB port 1 **X61** or USB port 2 **X62**).
2. Execute the "Restore" device command, e. g. with »PLC Designer«: Set **0x2022:043** to "1: On / Start".

The selected data backup is loaded into the controller regardless of the version. The data recovery progress is shown in **0x2022:043**. When the update is complete, the status "0: off / ready" is shown in **0x2022:043**.

3. Remove the USB stick when the loading process is completed.
4. Restart the controller.

Data recovery using device parameters is completed.



Parameter

Address	Name / setting range / [default setting]	Information	
0x2022:043	Device commands: Restore	<ul style="list-style-type: none"> Setting can only be changed if application status (displayed in 0x5810:001) is not equal to "1: Running". When the device command has been executed successfully, the value 0 is shown. Do not switch off the supply voltage or remove the SD card from the controller while the data recovery is being executed! 	
	<ul style="list-style-type: none"> Settings can only be changed if the PLC application is not in the "Running" status. For further possible settings, see parameter 0x2022:040. □ 137 		
	0 Off / ready		Only status feedback
	101 No SD card connected		
	102 SD card is write protected		
	103 SD card is full		
	104 USB stick not mounted		
	105 Backup file on USB stick wrong, double or in the wrong path		
	106 USB stick is full		
	107 Device no memory space left		
	108 Firmware size too large		
	109 User data size too large		
	110 Up/Downgrade successful - remove USB stick and restart the device		
	111 Application is still running - stop application first		
112 Other device command active - wait for end of execution			
113 Error - see Logbook for details			



12.6 Update firmware

This function allows you to update the PLC runtime system (firmware).



Only use suitable USB sticks for the controller!

Due to their shape, some USB sticks may not be inserted deep enough into the USB socket of the controller. This can cause problems that do not always suggest the USB stick as the cause.

Preconditions

- Installed Lenze »EASY Package Manager«
- Installed Lenze »EASY Starter - Firmware loader«
- USB stick with valid firmware

General notes

- It is possible to update to a higher or lower version.
- The update can be carried out either by switching the controller to power or via a device parameter.
- Details of the update are entered in the logbook.
- Firmware updates are indicated by the status LEDs on the controller:

"STA" LED (yellow/green)	Meaning
■ ■ ■ ■	Process (Backup / Restore / Upgrade / Downgrade) running.
■■■■■	Process (Backup / Restore / Upgrade / Downgrade) completed.

General procedure

1. Prepare the USB stick.
2. Insert the USB stick into the controller.
3. Restart the controller by power switching or execute the "Start Up/Downgrade" device command.



Do not switch off the device during data backup and do not remove the USB stick from the device! Note the status display of the yellow "STA" LED. ▶ [Status LEDs](#) [147](#)

Details

How to prepare the USB stick:

1. If the firmware to be installed is not yet available on the engineering PC: Select and install firmware in the "EASY Package Manager".
2. Copy the firmware to be installed to the USB stick with the "EASY Starter - Firmware loader".

The firmware is automatically stored in the directory "<USB-Stick>\firmware\active".

How to update the firmware using power switching:

1. Insert the prepared USB stick into the USB port 1 **X61** or USB port 2 **X62** of the controller.
2. Restart the controller by power switching.

The selected firmware is loaded into the controller regardless of the version.

3. Remove the USB stick.
4. Then restart the controller by power switching.

The installation of the firmware using power switching is completed.



How to update the firmware using power switching:

1. Insert the prepared USB stick into the USB port 1 **X61** or USB port 2 **X62** of the controller.
2. Execute the "Start Up/Downgrade" device command, e. g. with »PLC Designer«: Set **0x2022:047** to "1: On / Start".

The selected firmware is loaded into the controller regardless of the version. The loading progress is shown in **0x2022:047**. When the process is complete, the status "0: off / ready" is shown in **0x2022:047**.

3. Remove the USB stick.
4. Then restart the controller by power switching.

The installation of the firmware using device parameters is completed.

Parameter

Address	Name / setting range / [default setting]	Information	
0x2022:047	Device commands: Start Up/Downgrade	<ul style="list-style-type: none"> • Setting can only be changed if application status (displayed in 0x5810:001) is not equal to "1: Running". • When the device command has been executed successfully, the value 0 is shown. • Do not switch off the power supply and do not remove the USB stick and SD card from the controller while the firmware is being updated! 	
	<ul style="list-style-type: none"> • Settings can only be changed if the PLC application is not in the "Running" status. 		
	0 Off / ready		Only status feedback
	1 On / start		Execute device command
	2 In progress		Only status feedback
	3 Action cancelled		
	4 Action cancelled		
	5 No access (Device disabled)		
	20 20%		
	40 40%		
	60 60%		
	80 80%		
	100 100%		
	101 No SD card connected		
	102 SD card is write protected		
	103 SD card is full		
	104 USB stick not mounted		
	105 Backup file on USB stick wrong, double or in the wrong path		
	106 USB stick is full		
	107 Device no memory space left		
108 Firmware size too large			
109 User data size too large			
110 Up/Downgrade successful - remove USB stick and restart the device			
111 Application is still running - stop application first			
112 Other device command active - wait for end of execution			
113 Error - see Logbook for details			



13 Replace controller

A defective controller can only be replaced by a device of the same product type. The replacement device must have the same features, such as optionally integrated communication cards and connections.



13.1 Dismount controller

More information

For certain tasks, more information is available in additional documents.

Document	Contents/topics
Configuration document	Basic information for ordering the product
Mounting instructions	Fundamental information on mounting the product

How to dismount the connected controller:

Precondition

- The voltage supply of the entire system and the controller is switched off.
- Supply connections, bus connections and all other connections have been removed from the controller.
- The first electronic module of the I/O system has been removed.

1. Remove the Controller.
 2. Remove the SD card from the card slot.
- The controller has been dismantled.

Mounting and dismounting the controller

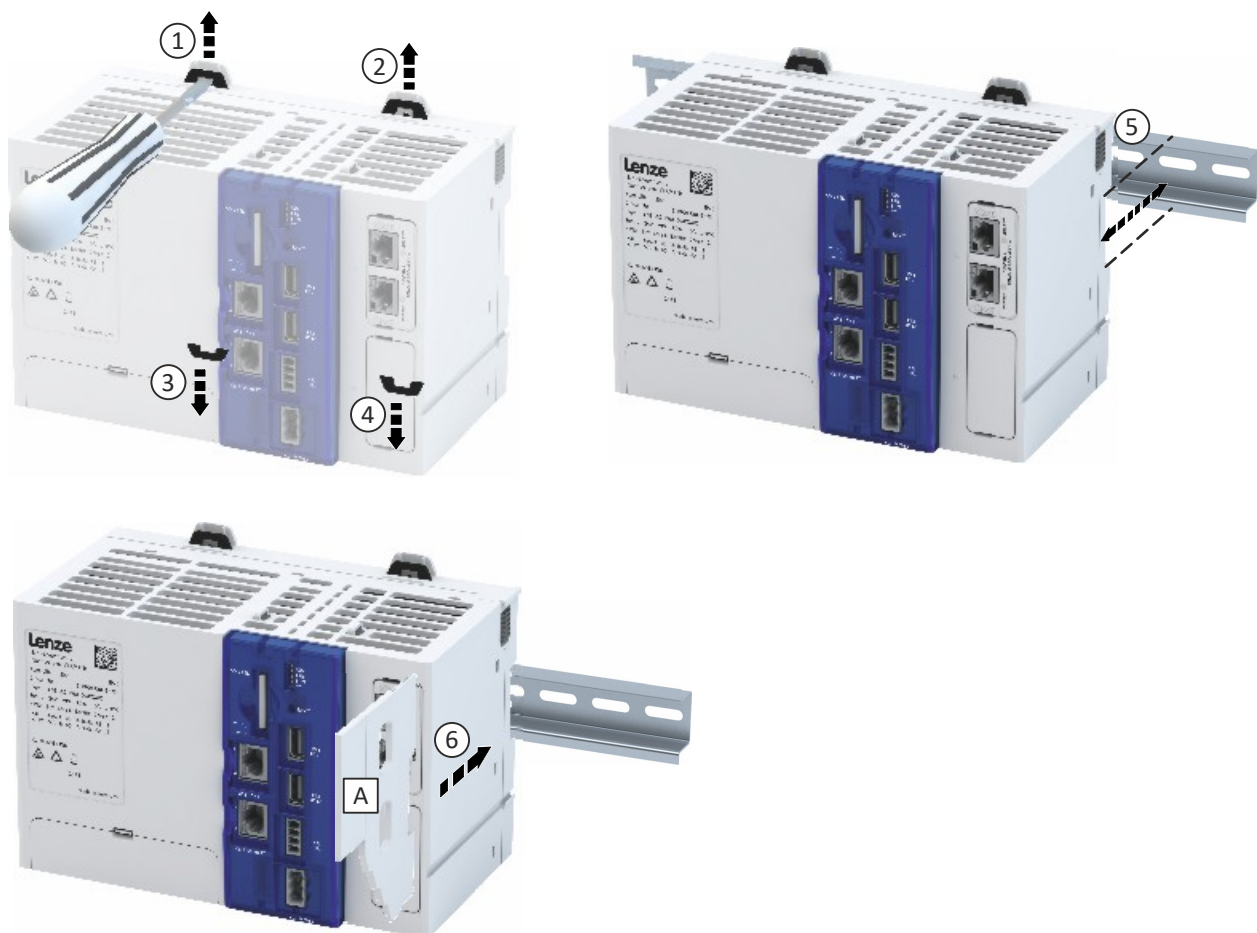

Replace controller

Install new controller



13.2 Install new controller

The current firmware version of the controller is also stored on the SD card used. If the SD card is inserted into a new device, the firmware version from the SD card is imported into the device automatically. This function ensures that the controller firmware and the boot project continue to match.

How to connect a new Controller:

1. Insert the SD card of the previously removed controller into the new one.
2. Mount the new Controller.
3. If an I/O system 1000 (EPM-Sxxx) is connected to the controller:
 - a) Mount and connect the electronic modules of the I/O system 1000 (EPM-Sxxx).
4. Connect supply connections, bus connections and all other connections to the Controller.
5. Switch on voltage supply.
The controller is mounted.
6. The controller starts the automatic firmware update if required:
 - a) The data of the SD card of the defective controller, such as an executable boot project and a visualization, is reused in the replacement device.
 - b) The firmware update can be detected by the status LEDs of the controller. Details on the update are entered in the logbook. ▶ [Logbook](#)  148



A voltage failure during the update should be avoided.



13.3 Reuse retain data

The retain data is stored automatically on the SD card. This data can then continue to be used if the device is replaced.



14 Diagnostics and fault elimination

This section contains information on error handling, drive diagnostics and fault analysis.



14.1 Status LEDs

LEDs on the front of the device indicate the current operating status. Depending on the running software application, different control modes of the LEDs are possible.

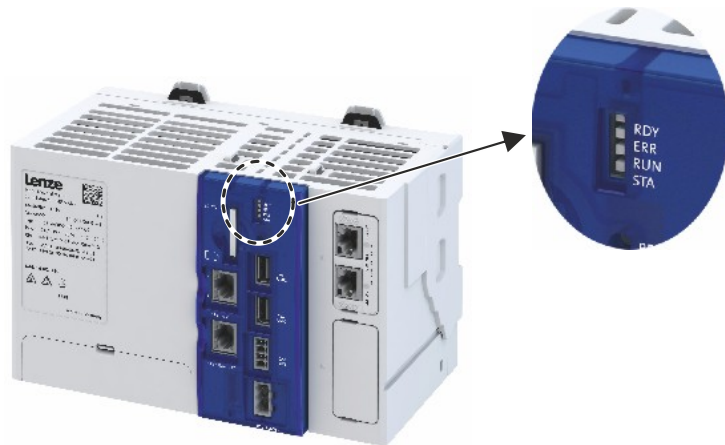

LED "RDY" (blue/yellow)	Meaning
Off	Device is switched off.
■ ■ ■ ■ ■	Device starts.
■■■■■■■■■■	Device is ready for operation.
■■■■■■■■■■	Value has fallen below the voltage
■ ■ ■ ■ ■ ■ ■ ■ ■ ■	System time must be set. ▶ Time 49
■ ■ ■ ■ ■ ■ ■ ■ ■ ■	Reset key was pressed during the boot process.

LED "ERR" (red/yellow)	Status	Meaning
Off	NO REACTION	There are no active error responses in the device.
■ ■ ■ ■ ■	WARNING	The device indicates a warning. The function of the device differs from the expected behavior. Note! If the "RDY" LED is blinking at the same time, a hardware error of the device has occurred.
■ ■ ■ ■ ■ ■ ■ ■ ■ ■	TROUBLE	The device indicates a fault. The function of the device is impaired.
■■■■■■■■■■	ERROR	The device indicates an error. <ul style="list-style-type: none"> The "ERR" LED remains active, regardless of whether the error is permanent or temporary. The application continues to run regardless of the status of the "ERR" LED. Exception: If an "exception" occurs, the application is stopped immediately. Events with "Error" severity can be reset via 0x2841 if the error condition no longer exists.
■ ■ ■ ■ ■ ■ ■ ■ ■ ■	Software reset	Software reset started. The reset button can be released.

"RUN" LED (yellow/green)	Meaning
■ ■ ■ ■ ■	PLC project is being loaded.
■■■■■■■■■■	PLC project is stopped.
■■■■■■■■■■	PLC project is started.

"STA" LED (yellow/green)	Meaning
■ ■ ■ ■ ■	Process (Backup / Restore / Upgrade / Downgrade) running.
■■■■■■■■■■	Process (Backup / Restore / Upgrade / Downgrade) completed.



14.2 Logbook

The devices are equipped with a logbook function which records system events and error messages. The entries in the logbook make it easier to diagnose the automation system.

The following information is processed by the logbook:

- Error messages and events of the application are displayed.
- Error messages and events of the application are saved on the SD card.

The logbook of the controller can be accessed via the »PLC-Designer«.

The event currently active in the controller can also be retrieved via the event monitor. [▶ PLC diagnostics](#) 149

Structure of a logbook entry

A logbook entry consists of the following information:

- Ascending numbering of the logbook entry
- Date / time of the logbook entry
- Application triggering the logbook entry
- Severity of the event in four categories
 - Information
 - Warning
 - Fault
 - Error
- Area as the event origin of the triggered error message.

Parameter

Address	Name / setting range / [default setting]	Information
0x2022:015	Device commands: Delete logbook	All entries in the logbook are deleted.
	0 Off / ready	Only status feedback
	1 On / start	Execute device command
	2 In progress	Only status feedback
	3 Action cancelled	
	4 No access	
	5 No access (Device disabled)	
0x2022:036	Device commands: Export Logbook	Exports the logbook for the upload into the engineering tools.
	0 Off / ready	Only status feedback
	1 On / start	Execute device command
	2 In progress	Only status feedback
	3 Action cancelled	
	4 No access	
	5 No access (Device disabled)	
0x2022:037	Device commands: Delete Logfiles	Deletion of log files on the device that were exported in an earlier step via 0x2022:036 (Export Logbook).
	0 Off / ready	Only status feedback
	1 On / start	Execute device command
	2 In progress	Only status feedback
	3 Action cancelled	
	4 No access	
	5 No access (Device disabled)	



14.3 Diagnostic parameters

14.3.1 PLC diagnostics

The following information may be retrieved for diagnostic purposes:

- Information on the event currently active in the controller (event monitor)
- Status of the SD card
- Available application credit / required application credit
- Dual use license
- Temperature of the control card and CPU
- Status of the application

Parameter

Address	Name / setting range / [default setting]	Information
0x2010:001	Device event monitor: EreignisortEvent location • Read only	Display of the event location for the currently pending event.
	0 No error	
	1 Functional safety	
	4 Basic settings	
	5 Communication	
	6 Kinematics	
	7 Motion	
	8 Technology application	
	9 Process control	
0x2010:002	Device event monitor: Severity • Read only	Display of the severity level for the currently active event.
	0 No response	
	1 Fault > CiA402	
	2 Warning	
	3 Fault	
	11 Information	
	13 Warning locked	
	15 Trouble > only logbook entry	
	16 Trouble	
	18 Fault > only logbook entry	
	19 Fault > application quick stop > quick stop	
	20 Fault > inverter quick stop > quick stop	
	21 Fault > inverter quick stop > inverter disabled	
23 Fault > inverter disabled		
0x2010:003	Device event monitor: Event status • Read only	Display of the event status for the currently pending event.
	0 No event active	
	1 Reset possible	
	2 Reset not possible	
0x2010:005	Device event monitor: Number of current event • Read only	Display of the event ID for the currently pending event.
0x2010:006	Device event monitor: Time stamp of current event • Read only	Display of the time stamp for the current upcoming event.
0x2012:001	Device information: SD card status • Read only	Display whether an SD card is inserted.
	0 No SD card connected	
	1 SD card connected	
0x2012:002	Device information: Application Credit available • Read only	Display of the application credit available on the SD card

Diagnostics and fault elimination

Diagnostic parameters
PLC diagnostics



Address	Name / setting range / [default setting]	Information
0x2012:003	Device information: Dual use licence • Read only	Display whether a dual-use license is available.
	0 Not available	
	1 Available	
0x2012:004	Device information: SD card total memory • Read only	Display of the total memory capacity of the SD card in kilobytes.
0x2012:005	Device information: SD card free memory • Read only	Display of the currently free memory on the SD card in kilobytes.
0x2012:006	Device information: SD card used memory • Read only: x kB	Display of the currently occupied memory on the SD card in kilobytes.
0x2012:007	Device information: License information • Read only	Display of license information (format: "x.x.x") with the following meaning: • 0.0.0: No license available • 155.0.0: Visualization license available for c550
0x2013:001	Application information: Active application • Read only	
	0 CiA 402	
	1 "CiA 402 advanced" technology application	
	10 "Speed Control" technology application	
	20 "Table Positioning" technology application	
	40 "Electronic Gearbox" technology application	
	41 "Sync and Correction" technology application	
	50 "Winder Dancer" technology application	
	51 "Winder Tension" technology application	
100 "User" technology application		
0x2013:002	Application information: Application Credit required • Read only	Display of the application credit required for the loaded application.
0x2539:002	Hardware-Diagnose: Control board temperature • Read only: x °C	Interior temperature of the device.
0x2539:003	Hardware-Diagnose: CPU temperature • Read only: x °C	Processor temperature of the device.
0x2D85:001	Fan diagnostics: Status • Read only: x %	Fan status in % • 0% = Fan off • 30%...100% = Speed in %
0x2D85:002	Fan diagnostics: Speed • Read only: x rpm	Speed in rpm.
0x5810:001	Application diagnostics: Application state • Read only	Display of the application status.
	0 Unknown/application missing	
	1 Running	
	2 Stopped	
	3 Stopped at breakpoint	
0x5810:002	Application diagnostics: Used memory size • Read only: x kB	Display of the memory used by the application in kilobytes.



14.3.2 Network diagnostics

Display information on the network option.



When switching on, the controller checks whether the parameter settings saved on the SD card match the device hardware and firmware. In the event of an incompatibility, a corresponding error message is displayed.



If the network module is added later, it must match the controller used.

Parameter

Address	Name / setting range / [default setting]	Information
0x231F:001	Communication module ID: Active module ID • Read only	Display of the network options currently configured in the device.
	48 No network	
	65 AS-Interface	
	67 CANopen	
	71 EtherNet/IP	
	72 BACnet	
	78 POWERLINK	
	80 PROFIBUS	
	82 PROFINET	▶ PROFINET IO-Device 106
	84 EtherCAT	▶ EtherCAT slave 98
0x231F:002	Communication module ID: Module ID connected • Read only • For the meaning of the display, see parameter 0x231F:001 . 151	Display of the network options currently available in the device.
	72 BACnet	

Related topics

- ▶ [EtherCAT master diagnostics](#) [75](#)
- ▶ [EtherCAT device diagnostics](#) [104](#)
- ▶ [PROFINET IO-Device diagnostics](#) [115](#)

14.3.3 Service life diagnostics

Display of the current operating and switch-on time of the controller.

Parameter

Address	Name / setting range / [default setting]	Information
0x2D81:001	Life-diagnosis: Operating time • Read only: x s	Display of how long the device has been powered in total, regardless of the state of the soft PLC (RUN/STOP). • The counter cannot be reset. • The seconds are not updated. • Representation: d:h:m:00
0x2D81:002	Life-diagnosis: Power-on time • Read only: x s	Display of how long the device has been supplied with voltage since it was last switched on, regardless of the status of the soft PLC (RUN/STOP). • The counter starts again at 00:00:00:00 when the power is next switched on. • Representation: d:h:m:s
0x2D81:004	Life-diagnosis: Main switching cycles • Read only	Display of the number of switching cycles of the mains voltage.



14.4 PLC core dump

A core dump is a file that records the state of an application at a particular point in its execution. A core dump file is created automatically when an exception error or crash has occurred in the PLC application. The core dump file can then be used to debug the crash without accessing the controller. When this file is loaded into the "PLC Designer", the content of all variables of the application is displayed. In addition, further details about the crash, such as the callstack, are available. All information is retrieved from the core dump file only.

For a PLC application, the core dump file contains the following information:

- Memory content
- Callstack
- Stack
- PLC log

Core dump files have the extension ".core" (e.g. "application.core") and are stored on the controller in the directory "/tmp/user_data".



14.5 Event handling

14.5.1 Severity

When certain events occur, the controller reacts depending on the severity level defined for the event.

Severity "No response"

The event is completely ignored (does not affect the running process).

Severity "Information"

The event is completely ignored (does not affect the running process). However, logging takes place in the [Logbook](#). [148](#)

Severity "Warning"

The event does not severely affect the process and may be also ignored in consideration of safety aspects.

Severity "Error"

- The red "ERR" LED on the controller is permanently on.
- A running application continues to run.
- **Exception:** If an "exception" occurs, the application is stopped immediately. (Application status `0x5810:001` = "Stopped")

Severity "Fault"

The function of the device is impaired. For example, a loaded boot application cannot be set to the "RUN" state.

14.5.2 Event reset

Events with "Error" severity can be reset.

Parameter

Address	Name / setting range / [default setting]	Information
0x2841	Reset error 0 ... [0] ... 1	1 = reset error

Diagnostics and fault elimination

Events, causes and remedies
Event ID overview



14.6 Events, causes and remedies

14.6.1 Event ID overview

Event ID	Event	Severity
671159298	0x28011402 Opening the parameter description failed	Fault
671159299	0x28011403 Opening the parameter set failed	Fault
671421185	0x28051301 Boot application - More Application Credit required	Trouble
671421186	0x28051302 Application requires dual-use license	Trouble
671421187	0x28051303 Powercaps not fully charged	Trouble
671421188	0x28051304 SD card is write protected - Running application is prevented	Trouble
671481904	0x28060030 PowerDown detected	Information
671547411	0x28070013 Initialization of the real-time clock failed	Fault
671547418	0x2807001A Charge state of buffer capacitors Real-time clock is low	Warning
671612938	0x2808000A Device starts without SD card	Fault
671678788	0x28090144 Firmware is not compatible with this device	Fault
671678814	0x2809015E SD card is not from this device - abort backup	Fault
671678815	0x2809015F Backup is not compatible with this device - abort restore	Fault
671678816	0x28090160 SD card is not from this device - abort Up/Downgrade	Fault
671678817	0x28090161 SD card not mounted	Fault
671678818	0x28090162 SD card is write protected	Fault
671678819	0x28090163 SD card does not have enough free space	Fault
671678820	0x28090164 USB stick not mounted	Fault
671678821	0x28090165 USB stick does not have correct backup structure	Fault
671678822	0x28090166 USB stick does not have enough free space	Fault
671678825	0x28090169 SD card contains too much stored project data	Fault
671678826	0x2809016A Backup succeeded	Information
671678827	0x2809016B Device command is blocked by a running PLC application	Fault
671678830	0x2809016E Firmware is not compatible with this hardware version	Fault
671744011	0x280A000B Too many I/Os for task cycle time (I/O module msg. 11)	Fault
671744012	0x280A000C Parameter access I/O modules is restricted (I/O module msg. 12)	Fault
671744032	0x280A0020 Internal error (I/O module msg. 32)	Fault
671744033	0x280A0021 Internal error (I/O module msg. 33)	Fault
671744099	0x280A0063 Too many I/Os for task cycle time (I/O module msg. 99)	Fault
671744100	0x280A0064 Too many I/Os for task cycle time (I/O module msg. 100)	Fault
671744101	0x280A0065 Too many I/Os for task cycle time (I/O module msg. 101)	Fault
671744102	0x280A0066 Too many I/Os for task cycle time (I/O module msg. 102)	Fault
671744103	0x280A0067 Too many I/Os for task cycle time (I/O module msg. 103)	Fault
671744104	0x280A0068 Timeout backplane bus communication (I/O module msg. 104)	Fault
671744105	0x280A0069 Timeout backplane bus communication (I/O module msg. 105)	Fault
671744106	0x280A006A Timeout backplane bus communication (I/O module msg. 106)	Fault
671744107	0x280A006B Timeout backplane bus communication (I/O module msg. 107)	Fault
671744108	0x280A006C Timeout backplane bus communication (I/O module msg. 108)	Fault
671744109	0x280A006D Timeout backplane bus communication (I/O module msg. 109)	Fault
671744111	0x280A006F Internal error (I/O module msg. 110)	Fault
671744112	0x280A0070 Powerfail backplane bus detected (I/O module msg. 112)	Fault
671744116	0x280A0074 Timeout backplane bus communication (I/O module msg. 116)	Fault
671744117	0x280A0075 Timeout backplane bus communication (I/O module msg. 117)	Fault
671744118	0x280A0076 Timeout backplane bus communication (I/O module msg. 118)	Fault
671744119	0x280A0077 Timeout backplane bus communication (I/O module msg. 119)	Fault
671744120	0x280A0078 Timeout backplane bus communication (I/O module msg. 120)	Fault
671744121	0x280A0079 Timeout backplane bus communication (I/O module msg. 121)	Fault
671744136	0x280A0088 Configuration error I/O module topology (I/O module msg. 136)	Fault
671744137	0x280A0089 Too many tasks for I/O module operation (I/O module msg. 137)	Fault
671744138	0x280A008A Internal error (I/O module msg. 138)	Fault
671744139	0x280A008B Internal error (I/O module msg. 139)	Fault
671744140	0x280A008C Internal error (I/O module msg. 140)	Fault



Diagnostics and fault elimination

Events, causes and remedies

Event ID overview

Event ID		Event	Severity
671744181	0x280A00B5	Internal error (I/O module msg. 181)	Fault
671744200	0x280A00C8	Internal error (I/O module msg. 200)	Fault
671744220	0x280A00DC	Internal error (I/O module msg. 220)	Fault
671744221	0x280A00DD	Internal error (I/O module msg. 221)	Fault
671744222	0x280A00DE	I/O system driver could not be opened (I/O module msg. 222)	Fault
671810816	0x280B0500	PLC buffer overflow	Warning
704733578	0x2A01618A	Warning - Internal fan	Warning
805311432	0x300013C8	CoE - SDO Abort 'Toggle bit not alternated (0x05030000)'	Information
805311433	0x300013C9	CoE - SDO Abort 'SDO protocol time-out (0x05040000)'	Warning
805311434	0x300013CA	CoE - SDO Abort 'Client/server command specifier not valid or unknown (0x05040001)'	Information
805311435	0x300013CB	CoE - SDO Abort 'Invalid block size (block mode only) (0x05040002)'	Information
805311436	0x300013CC	CoE - SDO Abort 'Invalid sequence number (block mode only) (0x05040003)'	Information
805311437	0x300013CD	CoE - SDO Abort 'CRC error (block mode only) (0x05040004)'	Information
805311438	0x300013CE	CoE - SDO Abort 'Out of memory (0x05040005)'	Information
805311439	0x300013CF	CoE - SDO Abort 'Unsupported access to an object (0x06010000)'	Information
805311440	0x300013D0	CoE - SDO Abort 'Attempt to read a write only object (0x06010001)'	Information
805311441	0x300013D1	CoE - SDO Abort 'Attempt to write a read only object (0x06010002)'	Information
805311442	0x300013D2	CoE - SDO-Abort 'Object does not exist in the object dictionary (0x06020000)'	Information
805311443	0x300013D3	CoE - SDO Abort 'Object cannot be mapped to the PDO (0x06040041)'	Information
805311444	0x300013D4	CoE - SDO Abort 'Number and length of objects to be mapped exceed PDO length (0x06040042)'	Information
805311445	0x300013D5	CoE - SDO Abort 'General parameter incompatibility (0x06040043)'	Information
805311446	0x300013D6	CoE - SDO Abort 'General internal incompatibility in the device (0x06040047)'	Information
805311447	0x300013D7	CoE - SDO Abort 'Access failed due to an hardware error (0x06060000)'	Information
805311448	0x300013D8	CoE - SDO Abort 'Data type or length of service parameters do not match (0x06070010)'	Information
805311449	0x300013D9	CoE - SDO Abort 'Data type does not match, service parameter too high (0x06070012)'	Information
805311450	0x300013DA	CoE - SDO Abort 'Data type does not match, service parameter too low (0x06070013)'	Information
805311451	0x300013DB	CoE - SDO Abort 'Subindex does not exist (0x06090011)'	Information
805311452	0x300013DC	CoE - SDO Abort 'Write access - Parameter value exceeds limits (0x06090030)'	Information
805311453	0x300013DD	CoE - SDO Abort 'Write access - Parameter value too high (0x06090031)'	Information
805311454	0x300013DE	CoE - SDO Abort 'Write access - Parameter value too low (0x06090032)'	Information
805311455	0x300013DF	CoE - SDO Abort 'Maximum value less than minimum value (0x06090036)'	Information
805311456	0x300013E0	CoE - SDO Abort 'General error (0x08000000)'	Information
805311457	0x300013E1	CoE - SDO Abort 'Data cannot be transferred/stored in application (0x08000020)'	Information
805311458	0x300013E2	CoE - SDO Abort 'Local control - Data cannot be transferred/stored in application (0x08000021)'	Information
805311459	0x300013E3	CoE - SDO Abort 'Actual device state - Data cannot be transferred/stored in application (0x08000022)'	Information
805311460	0x300013E4	CoE - SDO Abort 'Object dictionary - Dynamic generation fails or object dictionary is missing (0x08000023)'	Information
805311461	0x300013E5	CoE - SDO Abort 'Unknown abort code'	Information
805311462	0x300013E6	CoE - Invalid parameter	Information
805311463	0x300013E7	CoE - CoE protocol not supported	Information
805311464	0x300013E8	CoE - Unknown FoE error	Information
805311465	0x300013E9	CoE - FoE error 'Not found'	Information
805311466	0x300013EA	CoE - FoE error 'Access denied'	Information
805311467	0x300013EB	CoE - FoE error 'Disk full'	Information
805311468	0x300013EC	CoE - FoE error 'Illegal'	Information
805311469	0x300013ED	CoE - FoE error 'Wrong packet number'	Information
805311470	0x300013EE	CoE - FoE error 'Already existing'	Information
805311471	0x300013EF	CoE - FoE error 'User missing'	Information
805311472	0x300013F0	CoE - FoE error 'Only possible in bootstrap'	Information
805311473	0x300013F1	CoE - FoE error 'No bootstrap'	Information
805311474	0x300013F2	CoE - FoE error 'No access rights'	Information
805311475	0x300013F3	CoE - FoE error 'Program error'	Information
805311476	0x300013F4	CoE - FoE error 'Invalid parameter'	Information

Diagnostics and fault elimination

Events, causes and remedies
Event ID overview



Event ID	Event	Severity
805311881	0x30001589 EtherCAT - State change of master successful	Fault
805311882	0x3000158A EtherCAT - Bus scan successful	Fault
805311883	0x3000158B EtherCAT - Bus scan error	Fault
805311892	0x30001594 CoE - Emergency request	Information
805311893	0x30001595 Cyclic command WKC error	Fault
805311894	0x30001596 Master init command WKC error	Warning
805311895	0x30001597 Slave init command WKC error	Warning
805311896	0x30001598 EoE receive WKC error	Warning
805311897	0x30001599 CoE receive WKC error	Warning
805311898	0x3000159A FoE receive WKC error	Fault
805311900	0x3000159C EoE send WKC error	Warning
805311901	0x3000159D CoE send WKC error	Warning
805311902	0x3000159E FoE send WKC error	Warning
805311909	0x300015A5 Init command response error - No response	Warning
805311910	0x300015A6 Init command response error - Validation error	Warning
805311911	0x300015A7 Init command response error - Failed	Warning
805311912	0x300015A8 Master init command response error - No response	Warning
805311913	0x300015A9 Master init command response error - Validation error	Warning
805311915	0x300015AB Mailbox init command timeout	Warning
805311916	0x300015AC At least one EtherCAT slave not in 'Operational'	Warning
805311917	0x300015AD EtherCAT cable connected	Information
805311918	0x300015AE EtherCAT cable not connected	Information
805311921	0x300015B1 At least one slave is in state 'Error'	Warning
805311922	0x300015B2 Slave error	Warning
805311923	0x300015B3 Communication to device interrupted	Warning
805311924	0x300015B4 SDO abort	Warning
805311925	0x300015B5 DC slaves are 'in-sync'	Information
805311926	0x300015B6 DC slaves are 'out-of-sync'	Warning
805312086	0x30001656 Communication to device interrupted	Information
805312087	0x30001657 Slave is not in expected status	Warning
805312112	0x30001670 Bus scan timeout	Warning
805312568	0x30001838 Configuration error - Check of VendorID failed	Warning
805312569	0x30001839 Configuration error - Check of ProductCode failed	Information
805312570	0x3000183A Configuration error - Check of Revision failed	Information
805312571	0x3000183B Configuration error - Check of VendorID failed	Information
805312572	0x3000183C Configuration error - Odd device at bus end	Information
805312578	0x30001842 Internal error counter resetted	Information
805312580	0x30001844 All slaves 'Operational' again	Information
805312581	0x30001845 Cyclic command WKC error	Warning
805312582	0x30001846 Frame response error	Warning
805312583	0x30001847 Not all slaves are 'Operational'	Information
805312584	0x30001848 Emergency message - Overflow, further messages blocked	Warning
805312588	0x3000184C New configuration loaded	Information
805312589	0x3000184D New configuration loaded, no slaves defined	Information
805312590	0x3000184E Master - Start failed, configuration error	Information
805312591	0x3000184F New configuration loaded from slaves EEPROM	Information
805312598	0x30001856 Master - Start failed	Warning
805312599	0x30001857 Master - Start failed, bus configuration error	Warning
805312600	0x30001858 Master - Start failed, EtherCAT cable disconnected	Warning
805312601	0x30001859 Master - Start failed, DC/DCM configuration	Warning
805312602	0x3000185A Master - Start failed, cannot set slaves to 'Pre-Operational'	Warning
805312608	0x30001860 Master - Set 'Operational' failed	Warning
805312610	0x30001862 Master - Set 'Operational' failed, EtherCAT cable disconnected	Warning
805312613	0x30001865 Master - Set 'Operational' takes some time...	Warning
805312614	0x30001866 Master - Set 'Operational' failed, time-out	Warning



Diagnostics and fault elimination

Events, causes and remedies

Event ID overview

Event ID	Event	Severity
805312615	0x30001867 Master - Set 'Operational' failed, slave error	Warning
805312616	0x30001868 Master - Set 'Operational' aborted by reset command	Warning
805312618	0x3000186A Master - Stopping failed	Warning
805312619	0x3000186B Master - Stopping failed, cannot set Slaves 'Pre-Operational'	Warning
805312628	0x30001874 Master - Shutdown failed	Warning
805312638	0x3000187E Remote API Server - Start failed	Warning
805312648	0x30001888 Start Download Service	Information
805312649	0x30001889 Download Service done	Information
805312668	0x3000189C MMC - Internal error	Warning
805312669	0x3000189D MMC - 'Modular Machine Configuration' is active	Information
805312670	0x3000189E MMC - Service started	Information
805312671	0x3000189F MMC - Service stopped	Information
805312672	0x300018A0 MMC - Error in configuration files	Warning
805312673	0x300018A1 MMC - File does not exist	Warning
805312674	0x300018A2 MMC - Parsing error	Warning
805312675	0x300018A3 MMC - parsing of file successful	Warning
805312676	0x300018A4 MMC - Devices not sorted in ascending order or devices missing	Warning
805312677	0x300018A5 MMC - Number of devices in device tree differs	Warning
805312678	0x300018A6 MMC - Device type mismatch for Alias Address	Warning
805312679	0x300018A7 MMC - Invalid Alias Address	Warning
805312680	0x300018A8 MMC - Duplicated Alias Address	Warning
805312681	0x300018A9 MMC - No configuration checks	Information
805312682	0x300018AA MMC - Invalid configuration	Warning
805312683	0x300018AB MMC - Mandatory slave missing	Warning
805312684	0x300018AC MMC - Optional slave is present, but not allowed	Warning
805312685	0x300018AD MMC - No valid service active	Warning
805312686	0x300018AE MMC - Address assignment error, less slaves connected than configured	Warning
805312687	0x300018AF MMC - Address assignment error, more slaves connected than configured	Fault
805312688	0x300018B0 MMC - Address assignment error, invalid device	Fault
805312689	0x300018B1 MMC - Address assignment successful	Information
805312690	0x300018B2 MMC - Address assignment failed	Information
805312691	0x300018B3 MMC - Address assignment done	Information
805312692	0x300018B4 MMC - Address assignment error, writing address by CoE	Warning
805312693	0x300018B5 MMC - Slave identification error	Warning
805312694	0x300018B6 MMC - Slave identification error, slave ident data failed	Warning
805312695	0x300018B7 MMC - Service state cannot be changed, set bus to 'INIT' first	Information
805312768	0x30001900 CoE - Emergency request	Information
822310534	0x31037686 Network - Configuration error	Fault
822313360	0x31038190 Network - Watchdog time-out	Trouble
822313361	0x31038191 Network - Disruption of cyclic data exchange	No response
822313362	0x31038192 Network - Initialization error	Trouble
822313363	0x31038193 Network - Invalid cyclic process data	Trouble
822313607	0x31038287 Network - Invalid configuration	Trouble
822313608	0x31038288 Network - Max. count of supported process data reached	Fault
827331073	0x31501201 Address space update failed	Warning
827331074	0x31501202 Client user authentication failed	Warning
827331075	0x31501203 Client operation failed	Warning
827331078	0x31501206 Client has been rejected because the certificate is not trusted	Warning
827331329	0x31501301 Out of memory	Fault
827331330	0x31501302 Failed to update address space	Fault

Diagnostics and fault elimination

Events, causes and remedies
Causes and remedies



14.6.2 Causes and remedies

671159298 | 0x28011402 **Opening the parameter description failed**

Cause	Remedy	Severity/response
Parameter description is missing or faulty. No or incorrect parameter description on the device.	Update boot project or device firmware. <ul style="list-style-type: none">Update boot project. This also updates the parameter set description.If updating the boot project does not fix the error, update the device firmware. The device parameters are also updated as a result.	Fault

671159299 | 0x28011403 **Opening the parameter set failed**

Cause	Remedy	Severity/response
Parameter set file is missing or faulty. No or faulty parameter set file on the device.	Update boot project or restart device. <ul style="list-style-type: none">Update boot project. This also updates the parameter set.Restart the device if necessary.	Fault

671421185 | 0x28051301 **Boot application - More Application Credit required**

Cause	Remedy	Severity/response
The loaded application requires more "Application Credit" than is available on the SD card.	Use SD card with sufficient "Application Credit".	Trouble

671421186 | 0x28051302 **Application requires dual-use license**

Cause	Remedy	Severity/response
The application requires a device with "dual use license".	Use device with "dual use license".	Trouble

671421187 | 0x28051303 **Powercaps not fully charged**

Cause	Remedy	Severity/response
As long as the buffer capacitors are not charged, the start of an application is prevented.	Take into account the charging time of the buffer capacitors during the boot process.	Trouble

671421188 | 0x28051304 **SD card is write protected - Running application is prevented**

Cause	Remedy	Severity/response
Write protection is activated for the SD card. This makes it impossible to start an application.	Remove write protection from the SD card and restart the device.	Trouble

671481904 | 0x28060030 **PowerDown detected**

Cause	Remedy	Severity/response
Device is shutting down.	For information only. No remedy necessary.	Information



Diagnostics and fault elimination

Events, causes and remedies
Causes and remedies

671547411 | 0x28070013 Initialization of the real-time clock failed

Cause	Remedy	Severity/response
Error initializing the real-time function. Time may not be usable.	Restart device and check logbook.	Fault

671547418 | 0x2807001A Charge state of buffer capacitors Real-time clock is low

Cause	Remedy	Severity/response
Device was disconnected from the power supply for too long.	Supply the device with power and set the system time.	Warning

671612938 | 0x2808000A Device starts without SD card

Cause	Remedy	Severity/response
Device starts without SD card.	If appropriate, insert SD card.	Fault

671678788 | 0x28090144 Firmware is not compatible with this device

Cause	Remedy	Severity/response
The selected firmware does not match the device.	Ensure that the selected firmware exactly matches the target device. Example: A c550 controller can only be updated with a c550 firmware.	Fault

671678814 | 0x2809015E SD card is not from this device - abort backup

Cause	Remedy	Severity/response
Internal reviews are performed prior to implementation. Result: The inserted SD card was not recognized by the device. The backup was canceled.	Start device with a new/empty SD card. Note: If there is no new/empty SD card, you can also delete data from the existing SD card. However, do not delete the license data! (Directory "Licenses_do_not_delete" including content)	Fault

671678815 | 0x2809015F Backup is not compatible with this device - abort restore

Cause	Remedy	Severity/response
The present backup does not match the device.	Ensure that the backup at hand exactly matches the target device. Example: A backup from the c550 controller can only be restored to a c550 controller.	Fault

671678816 | 0x28090160 SD card is not from this device - abort Up/Downgrade

Cause	Remedy	Severity/response
Internal reviews are performed prior to implementation. Result: The inserted SD card was not recognized by the device. The upgrade/downgrade was canceled.	Start device with a new/empty SD card. Note: If there is no new/empty SD card, you can also delete data from the existing SD card. However, do not delete the license data! (Directory "Licenses_do_not_delete" including content)	Fault

Diagnostics and fault elimination

Events, causes and remedies
Causes and remedies



671678817 | 0x28090161 SD card not mounted

Cause	Remedy	Severity/response
The inserted SD card was not recognized by the device.	<ul style="list-style-type: none">• Check whether the SD card is inserted/engaged correctly.• Test another SD card.	Fault

671678818 | 0x28090162 SD card is write protected

Cause	Remedy	Severity/response
The inserted SD card is write-protected.	For the SD card, slide the lock switch to the "Unlock" position to remove the physical write protection.	Fault

671678819 | 0x28090163 SD card does not have enough free space

Cause	Remedy	Severity/response
There is not enough free space on the SD card.	Remove unneeded data from the SD card until at least 200 MB of free space is available.	Fault

671678820 | 0x28090164 USB stick not mounted

Cause	Remedy	Severity/response
The inserted USB stick was not recognized by the device.	<ul style="list-style-type: none">• Check if the USB stick is inserted correctly.• Only use USB sticks approved by the manufacturer.	Fault

671678821 | 0x28090165 USB stick does not have correct backup structure

Cause	Remedy	Severity/response
Backup file on the USB stick does not exist, is duplicated or is in the wrong directory.	Check the content of the USB stick. To do this, copy the corresponding data backup on the USB stick from the "firmware\archive_" to "firmware\active" directory. However, the directory "firmware\active" may only contain one file at a time.	Fault

671678822 | 0x28090166 USB stick does not have enough free space

Cause	Remedy	Severity/response
There is not enough free space on the USB stick.	Use a USB stick with at least 365 MB free space.	Fault

671678825 | 0x28090169 SD card contains too much stored project data

Cause	Remedy	Severity/response
The SD card is used to store project data of the controller. The sum of the project data stored on the SD card is too large (>165 MB).	Remove unneeded project data from the SD card until the value falls below the maximum size for project data (165 MB).	Fault

671678826 | 0x2809016A Backup succeeded

Cause	Remedy	Severity/response
The backup was created successfully.	Remove USB stick from controller and restart controller.	Information



671678827 | 0x2809016B **Device command is blocked by a running PLC application**

Cause	Remedy	Severity/response
Device command/setting is blocked by a running PLC application.	Execute device command/setting if the status of the application (display in 0x5810:001) is not equal to "1: Running".	Fault

671678830 | 0x2809016E **Firmware is not compatible with this hardware version**

Cause	Remedy	Severity/response
The firmware is not released for this device. The hardware version is too low.	Select firmware version that is compatible with the hardware version of the device.	Fault

671744011 | 0x280A000B **Too many I/Os for task cycle time (I/O module msg. 11)**

Cause	Remedy	Severity/response
Too many I/O modules for the selected task cycle time.	Increase task cycle time.	Fault

671744012 | 0x280A000C **Parameter access I/O modules is restricted (I/O module msg. 12)**

Cause	Remedy	Severity/response
<p>The controller could not access all parameters of the I/O modules. Process data communication (PDO) is not restricted.</p> <p>a) When the controller is started, the task load is close to the cycle time and there are very many configurable I/O modules connected to the backplane bus of the controller.</p> <p>b) During operation the task load is close to the cycle time and at the same time the tabs of configurable I/O modules are displayed in the "PLC Designer".</p>	Increase cycle time of bus cycle tasks.	Fault

671744032 | 0x280A0020 **Internal error (I/O module msg. 32)**

Cause	Remedy	Severity/response
Internal error	Restart device. If the error persists, contact the manufacturer.	Fault

671744033 | 0x280A0021 **Internal error (I/O module msg. 33)**

Cause	Remedy	Severity/response
Internal error	Restart device. If the error persists, contact the manufacturer.	Fault

671744099 | 0x280A0063 **Too many I/Os for task cycle time (I/O module msg. 99)**

Cause	Remedy	Severity/response
Error while creating the task assigned to the backplane bus. The number of I/O modules or the size of the process image cannot be processed by the controller. The error occurs when starting the PLC application.	Reduce the number of I/O modules.	Fault

Diagnostics and fault elimination

Events, causes and remedies
Causes and remedies



671744100 | 0x280A0064 **Too many I/Os for task cycle time (I/O module msg. 100)**

Cause	Remedy	Severity/response
<p>Error during processing of backplane bus telegrams. This error occurs during operation.</p> <p>a) Error in the PLC application: The task runtime is longer than the set task interval. The jitter of the backplane bus task is too high (>120 µs).</p> <p>b) EMC influences (transmission interference): The telegrams are transmitted in insufficient quality.</p> <p>c) Mechanical influences: Short circuits of the signal cables due to jammed sockets. Missing or dirty contacts. The telegrams are transmitted in insufficient quality.</p> <p>d) An I/O module is defective.</p> <p>e) The number of I/O modules or the size of the process image cannot be processed by the controller.</p> <p>f) Controller is defective. The MF LEDs light up on all modules.</p>	<p>a) Check PLC application for possible causes of runtime extension or jitter and correct if necessary.</p> <p>b) Check the shielding. Check whether the error is related to special events (e.g. switching on the drives).</p> <p>c) Check and clean contacts between I/O modules and sockets.</p> <p>d) Replace I/O modules one by one to find the defective module.</p> <p>e) Reduce the number of I/O modules.</p> <p>f) The MF LEDs light up for all modules: Measure the voltage at the 5 V contacts of the last module at the backplane bus (pin 3 and 5). Replace controller.</p>	Fault

671744101 | 0x280A0065 **Too many I/Os for task cycle time (I/O module msg. 101)**

Cause	Remedy	Severity/response
<p>Error during processing of backplane bus telegrams. This error occurs during operation.</p> <p>a) Error in the PLC application: The task runtime is longer than the set task interval. The jitter of the backplane bus task is too high (>120 µs).</p> <p>b) EMC influences (transmission interference): The telegrams are transmitted in insufficient quality.</p> <p>c) Mechanical influences: Short circuits of the signal cables due to jammed sockets. Missing or dirty contacts. The telegrams are transmitted in insufficient quality.</p> <p>d) An I/O module is defective.</p> <p>e) The number of I/O modules or the size of the process image cannot be processed by the controller.</p> <p>f) Controller is defective. The MF LEDs light up on all modules.</p>	<p>a) Check PLC application for possible causes of runtime extension or jitter and correct if necessary.</p> <p>b) Check the shielding. Check whether the error is related to special events (e.g. switching on the drives).</p> <p>c) Check and clean contacts between I/O modules and sockets.</p> <p>d) Replace I/O modules one by one to find the defective module.</p> <p>e) Reduce the number of I/O modules.</p> <p>f) The MF LEDs light up for all modules: Measure the voltage at the 5 V contacts of the last module at the backplane bus (pin 3 and 5). Replace controller.</p>	Fault



671744102 | 0x280A0066 **Too many I/Os for task cycle time (I/O module msg. 102)**

Cause	Remedy	Severity/response
<p>Error during processing of backplane bus telegrams. This error occurs during operation.</p> <p>a) Error in the PLC application: The task runtime is longer than the set task interval. The jitter of the backplane bus task is too high (>120 µs).</p> <p>b) EMC influences (transmission interference): The telegrams are transmitted in insufficient quality.</p> <p>c) Mechanical influences: Short circuits of the signal cables due to jammed sockets. Missing or dirty contacts. The telegrams are transmitted in insufficient quality.</p> <p>d) An I/O module is defective.</p> <p>e) The number of I/O modules or the size of the process image cannot be processed by the controller.</p> <p>f) Controller is defective. The MF LEDs light up on all modules.</p>	<p>a) Check PLC application for possible causes of runtime extension or jitter and correct if necessary.</p> <p>b) Check the shielding. Check whether the error is related to special events (e.g. switching on the drives).</p> <p>c) Check and clean contacts between I/O modules and sockets.</p> <p>d) Replace I/O modules one by one to find the defective module.</p> <p>e) Reduce the number of I/O modules.</p> <p>f) The MF LEDs light up for all modules: Measure the voltage at the 5 V contacts of the last module at the backplane bus (pin 3 and 5). Replace controller.</p>	Fault

671744103 | 0x280A0067 **Too many I/Os for task cycle time (I/O module msg. 103)**

Cause	Remedy	Severity/response
<p>Error during processing of backplane bus telegrams. This error occurs during operation.</p> <p>a) Error in the PLC application: The task runtime is longer than the set task interval. The jitter of the backplane bus task is too high (>120 µs).</p> <p>b) EMC influences (transmission interference): The telegrams are transmitted in insufficient quality.</p> <p>c) Mechanical influences: Short circuits of the signal cables due to jammed sockets. Missing or dirty contacts. The telegrams are transmitted in insufficient quality.</p> <p>d) An I/O module is defective.</p> <p>e) The number of I/O modules or the size of the process image cannot be processed by the controller.</p> <p>f) Controller is defective. The MF LEDs light up on all modules.</p>	<p>a) Check PLC application for possible causes of runtime extension or jitter and correct if necessary.</p> <p>b) Check the shielding. Check whether the error is related to special events (e.g. switching on the drives).</p> <p>c) Check and clean contacts between I/O modules and sockets.</p> <p>d) Replace I/O modules one by one to find the defective module.</p> <p>e) Reduce the number of I/O modules.</p> <p>f) The MF LEDs light up for all modules: Measure the voltage at the 5 V contacts of the last module at the backplane bus (pin 3 and 5). Replace controller.</p>	Fault

671744104 | 0x280A0068 **Timeout backplane bus communication (I/O module msg. 104)**

Cause	Remedy	Severity/response
<p>The data exchange between the backplane bus and the PLC application is not possible within the specified time.</p> <p>a) Follow-up error of the "Too many I/O modules..." error (I/O module messages 100 ... 103).</p> <p>b) Error in the PLC application: The task runtime is violated.</p> <p>c) Backplane bus structure: Many passive modules are plugged in between the I/O modules (EPM-S7xx/EPM-S9xx).</p>	<p>a) Check the error sequence in the logbook and eliminate the errors "Too many I/O modules..." (I/O module message 100 ... 103).</p> <p>b) Correct PLC application.</p> <p>c) Remove passive I/O modules, change structure.</p>	Fault

Diagnostics and fault elimination

Events, causes and remedies
Causes and remedies



671744105 | 0x280A0069 Timeout backplane bus communication (I/O module msg. 105)

Cause	Remedy	Severity/response
<p>The data exchange between the backplane bus and the PLC application is not possible within the specified time.</p> <p>a) Follow-up error of the "Too many I/O modules..." error (I/O module messages 100 ... 103).</p> <p>b) Error in the PLC application: The task runtime is violated.</p> <p>c) Backplane bus structure: Many passive modules are plugged in between the I/O modules (EPM-S7xx/EPM-S9xx).</p>	<p>a) Check the error sequence in the logbook and eliminate the errors "Too many I/O modules...". (I/O module message 100 ... 103).</p> <p>b) Correct PLC application.</p> <p>c) Remove passive I/O modules, change structure.</p>	Fault

671744106 | 0x280A006A Timeout backplane bus communication (I/O module msg. 106)

Cause	Remedy	Severity/response
<p>The data exchange between the backplane bus and the PLC application is not possible within the specified time.</p> <p>a) Follow-up error of the "Too many I/O modules..." error (I/O module messages 100 ... 103).</p> <p>b) Error in the PLC application: The task runtime is violated.</p> <p>c) Backplane bus structure: Many passive modules are plugged in between the I/O modules (EPM-S7xx/EPM-S9xx).</p>	<p>a) Check the error sequence in the logbook and eliminate the errors "Too many I/O modules...". (I/O module message 100 ... 103).</p> <p>b) Correct PLC application.</p> <p>c) Remove passive I/O modules, change structure.</p>	Fault

671744107 | 0x280A006B Timeout backplane bus communication (I/O module msg. 107)

Cause	Remedy	Severity/response
<p>The data exchange between the backplane bus and the PLC application is not possible within the specified time.</p> <p>a) Follow-up error of the "Too many I/O modules..." error (I/O module messages 100 ... 103).</p> <p>b) Error in the PLC application: The task runtime is violated.</p> <p>c) Backplane bus structure: Many passive modules are plugged in between the I/O modules (EPM-S7xx/EPM-S9xx).</p>	<p>a) Check the error sequence in the logbook and eliminate the errors "Too many I/O modules...". (I/O module message 100 ... 103).</p> <p>b) Correct PLC application.</p> <p>c) Remove passive I/O modules, change structure.</p>	Fault

671744108 | 0x280A006C Timeout backplane bus communication (I/O module msg. 108)

Cause	Remedy	Severity/response
<p>The data exchange between the backplane bus and the PLC application is not possible within the specified time.</p> <p>a) Follow-up error of the "Too many I/O modules..." error (I/O module messages 100 ... 103).</p> <p>b) Error in the PLC application: The task runtime is violated.</p> <p>c) Backplane bus structure: Many passive modules are plugged in between the I/O modules (EPM-S7xx/EPM-S9xx).</p>	<p>a) Check the error sequence in the logbook and eliminate the errors "Too many I/O modules...". (I/O module message 100 ... 103).</p> <p>b) Correct PLC application.</p> <p>c) Remove passive I/O modules, change structure.</p>	Fault



671744109 | 0x280A006D **Timeout backplane bus communication (I/O module msg. 109)**

Cause	Remedy	Severity/response
<p>The data exchange between the backplane bus and the PLC application is not possible within the specified time.</p> <p>a) Follow-up error of the "Too many I/O modules..." error (I/O module messages 100 ... 103).</p> <p>b) Error in the PLC application: The task runtime is violated.</p> <p>c) Backplane bus structure: Many passive modules are plugged in between the I/O modules (EPM-S7xx/EPM-S9xx).</p>	<p>a) Check the error sequence in the logbook and eliminate the errors "Too many I/O modules...". (I/O module message 100 ... 103).</p> <p>b) Correct PLC application.</p> <p>c) Remove passive I/O modules, change structure.</p>	Fault

671744111 | 0x280A006F **Internal error (I/O module msg. 110)**

Cause	Remedy	Severity/response
Internal error	Restart device. If the error persists, contact the manufacturer.	Fault

671744112 | 0x280A0070 **Powerfail backplane bus detected (I/O module msg. 112)**

Cause	Remedy	Severity/response
Voltage interruption detected.	-	Fault

671744116 | 0x280A0074 **Timeout backplane bus communication (I/O module msg. 116)**

Cause	Remedy	Severity/response
<p>The data exchange between the backplane bus and the PLC application is not possible within the specified time.</p> <p>a) Follow-up error of the "Too many I/O modules..." error (I/O module messages 100 ... 103).</p> <p>b) Error in the PLC application: The task runtime is violated.</p> <p>c) Backplane bus structure: Many passive modules are plugged in between the I/O modules (EPM-S7xx/EPM-S9xx).</p>	<p>a) Check the error sequence in the logbook and eliminate the errors "Too many I/O modules...". (I/O module message 100 ... 103).</p> <p>b) Correct PLC application.</p> <p>c) Remove passive I/O modules, change structure.</p>	Fault

671744117 | 0x280A0075 **Timeout backplane bus communication (I/O module msg. 117)**

Cause	Remedy	Severity/response
<p>The data exchange between the backplane bus and the PLC application is not possible within the specified time.</p> <p>a) Follow-up error of the "Too many I/O modules..." error (I/O module messages 100 ... 103).</p> <p>b) Error in the PLC application: The task runtime is violated.</p> <p>c) Backplane bus structure: Many passive modules are plugged in between the I/O modules (EPM-S7xx/EPM-S9xx).</p>	<p>a) Check the error sequence in the logbook and eliminate the errors "Too many I/O modules...". (I/O module message 100 ... 103).</p> <p>b) Correct PLC application.</p> <p>c) Remove passive I/O modules, change structure.</p>	Fault

Diagnostics and fault elimination

Events, causes and remedies
Causes and remedies



671744118 | 0x280A0076 Timeout backplane bus communication (I/O module msg. 118)

Cause	Remedy	Severity/response
<p>The data exchange between the backplane bus and the PLC application is not possible within the specified time.</p> <p>a) Follow-up error of the "Too many I/O modules..." error (I/O module messages 100 ... 103).</p> <p>b) Error in the PLC application: The task runtime is violated.</p> <p>c) Backplane bus structure: Many passive modules are plugged in between the I/O modules (EPM-S7xx/EPM-S9xx).</p>	<p>a) Check the error sequence in the logbook and eliminate the errors "Too many I/O modules...". (I/O module message 100 ... 103).</p> <p>b) Correct PLC application.</p> <p>c) Remove passive I/O modules, change structure.</p>	Fault

671744119 | 0x280A0077 Timeout backplane bus communication (I/O module msg. 119)

Cause	Remedy	Severity/response
<p>The data exchange between the backplane bus and the PLC application is not possible within the specified time.</p> <p>a) Follow-up error of the "Too many I/O modules..." error (I/O module messages 100 ... 103).</p> <p>b) Error in the PLC application: The task runtime is violated.</p> <p>c) Backplane bus structure: Many passive modules are plugged in between the I/O modules (EPM-S7xx/EPM-S9xx).</p>	<p>a) Check the error sequence in the logbook and eliminate the errors "Too many I/O modules...". (I/O module message 100 ... 103).</p> <p>b) Correct PLC application.</p> <p>c) Remove passive I/O modules, change structure.</p>	Fault

671744120 | 0x280A0078 Timeout backplane bus communication (I/O module msg. 120)

Cause	Remedy	Severity/response
<p>The data exchange between the backplane bus and the PLC application is not possible within the specified time.</p> <p>a) Follow-up error of the "Too many I/O modules..." error (I/O module messages 100 ... 103).</p> <p>b) Error in the PLC application: The task runtime is violated.</p> <p>c) Backplane bus structure: Many passive modules are plugged in between the I/O modules (EPM-S7xx/EPM-S9xx).</p>	<p>a) Check the error sequence in the logbook and eliminate the errors "Too many I/O modules...". (I/O module message 100 ... 103).</p> <p>b) Correct PLC application.</p> <p>c) Remove passive I/O modules, change structure.</p>	Fault

671744121 | 0x280A0079 Timeout backplane bus communication (I/O module msg. 121)

Cause	Remedy	Severity/response
<p>The data exchange between the backplane bus and the PLC application is not possible within the specified time.</p> <p>a) Follow-up error of the "Too many I/O modules..." error (I/O module messages 100 ... 103).</p> <p>b) Error in the PLC application: The task runtime is violated.</p> <p>c) Backplane bus structure: Many passive modules are plugged in between the I/O modules (EPM-S7xx/EPM-S9xx).</p>	<p>a) Check the error sequence in the logbook and eliminate the errors "Too many I/O modules...". (I/O module message 100 ... 103).</p> <p>b) Correct PLC application.</p> <p>c) Remove passive I/O modules, change structure.</p>	Fault



671744136 | 0x280A0088 **Configuration error I/O module topology (I/O module msg. 136)**

Cause	Remedy	Severity/response
<p>The I/O modules configured in the PLC application were not found on the backplane bus.</p> <p>a) The bus structure in the PLC application does not match the actual bus structure.</p> <p>b) There is no contact between the electronic module and the base module of the I/O module.</p> <p>c) There is no contact between two adjacent base modules of the I/O system.</p> <p>d) An I/O module is defective.</p> <p>e) The voltage supply to the I/O modules has been interrupted.</p> <p>f) Controller is defective. The MF LEDs light up on all modules.</p>	<p>a) Compare PLC application with the actual bus structure.</p> <p>b) Plug the electronic module firmly onto the base module.</p> <p>c) Plug in base modules correctly.</p> <p>d) Replace defective I/O module (the MF LEDs of the affected module light up).</p> <p>e) When using EPM-S702 modules, check and restore the power supply to the modules.</p> <p>f) The MF LEDs light up for all modules: Measure the voltage at the 5 V contacts of the last module at the backplane bus (pin 3 and 5). Replace controller.</p>	Fault

671744137 | 0x280A0089 **Too many tasks for I/O module operation (I/O module msg. 137)**

Cause	Remedy	Severity/response
Too many tasks for I/O module processing.	Reduce the number of tasks for processing I/O modules.	Fault

671744138 | 0x280A008A **Internal error (I/O module msg. 138)**

Cause	Remedy	Severity/response
Internal error	Restart device. If the error persists, contact the manufacturer.	Fault

671744139 | 0x280A008B **Internal error (I/O module msg. 139)**

Cause	Remedy	Severity/response
Internal error	Restart device. If the error persists, contact the manufacturer.	Fault

671744140 | 0x280A008C **Internal error (I/O module msg. 140)**

Cause	Remedy	Severity/response
Internal error	Restart device. If the error persists, contact the manufacturer.	Fault

671744181 | 0x280A00B5 **Internal error (I/O module msg. 181)**

Cause	Remedy	Severity/response
Internal error	Restart device. If the error persists, contact the manufacturer.	Fault

671744200 | 0x280A00C8 **Internal error (I/O module msg. 200)**

Cause	Remedy	Severity/response
Internal error	Restart device. If the error persists, contact the manufacturer.	Fault

Diagnostics and fault elimination

Events, causes and remedies
Causes and remedies



671744220 | 0x280A00DC **Internal error (I/O module msg. 220)**

Cause	Remedy	Severity/response
Internal error	Restart device. If the error persists, contact the manufacturer.	Fault

671744221 | 0x280A00DD **Internal error (I/O module msg. 221)**

Cause	Remedy	Severity/response
Internal error	Restart device. If the error persists, contact the manufacturer.	Fault

671744222 | 0x280A00DE **I/O system driver could not be opened (I/O module msg. 222)**

Cause	Remedy	Severity/response
The I/O system driver (backplane bus driver) could not be started after an update of the controller firmware or due to a defective device.	<ul style="list-style-type: none"> Update or restore the controller again. Replace controller. 	Fault

671810816 | 0x280B0500 **PLC buffer overflow**

Cause	Remedy	Severity/response
In the "PLC Designer" not all log messages could be displayed in the log dialog.	Open the log dialog in the "PLC Designer" only in situations where there is not a high volume of log messages.	Warning

704733578 | 0x2A01618A **Warning - Internal fan**

Cause	Remedy	Severity/response
Internal fan is blocked or rotates too slowly.	Clean fan and ventilation slots. If required, replace fan.	Warning

805311432 | 0x300013C8 **CoE - SDO Abort 'Toggle bit not alternated (0x05030000)'**

Cause	Remedy	Severity/response
The status of the toggle bit has not changed.	For information only. No remedy necessary.	Information

805311433 | 0x300013C9 **CoE - SDO Abort 'SDO protocol time-out (0x05040000)'**

Cause	Remedy	Severity/response
SDO protocol timeout	Check if timeout is set too low.	Warning

805311434 | 0x300013CA **CoE - SDO Abort 'Client/server command specifier not valid or unknown (0x05040001)'**

Cause	Remedy	Severity/response
Invalid or unknown specification symbol for the client/server command.	<ul style="list-style-type: none"> Check access authorization. Check object properties. 	Information

805311435 | 0x300013CB **CoE - SDO Abort 'Invalid block size (block mode only) (0x05040002)'**

Cause	Remedy	Severity/response
Invalid block size (only in "block mode")	<ul style="list-style-type: none"> Check access authorization. Check object properties. 	Information



Diagnostics and fault elimination

Events, causes and remedies
Causes and remedies

805311436 | 0x300013CC CoE - SDO Abort 'Invalid sequence number (block mode only) (0x05040003)'

Cause	Remedy	Severity/response
Invalid sequence number (only in "block mode")	Check access authorization. Check object properties.	Information

805311437 | 0x300013CD CoE - SDO Abort 'CRC error (block mode only) (0x05040004)'

Cause	Remedy	Severity/response
CRC error (only in "block mode")	Check access authorization. Check object properties.	Information

805311438 | 0x300013CE CoE - SDO Abort 'Out of memory (0x05040005)'

Cause	Remedy	Severity/response
Too little free space in the main memory.	Check access authorization. Check object properties.	Information

805311439 | 0x300013CF CoE - SDO Abort 'Unsupported access to an object (0x06010000)'

Cause	Remedy	Severity/response
Access denied.	Check access authorization. Check object properties.	Information

805311440 | 0x300013D0 CoE - SDO Abort 'Attempt to read a write only object (0x06010001)'

Cause	Remedy	Severity/response
Access denied.	Check access authorization.	Information

805311441 | 0x300013D1 CoE - SDO Abort 'Attempt to write a read only object (0x06010002)'

Cause	Remedy	Severity/response
Access denied.	Check access authorization.	Information

805311442 | 0x300013D2 CoE - SDO-Abort 'Object does not exist in the object dictionary (0x06020000)'

Cause	Remedy	Severity/response
Access denied.	Check access authorization. Check if object exists.	Information

805311443 | 0x300013D3 CoE - SDO Abort 'Object cannot be mapped to the PDO (0x06040041)'

Cause	Remedy	Severity/response
Access denied.	Check access authorization. Check if object exists.	Information

805311444 | 0x300013D4 CoE - SDO Abort 'Number and length of objects to be mapped exceed PDO length (0x06040042)'

Cause	Remedy	Severity/response
Access denied.	Check the length of the objects to be mapped.	Information

Diagnostics and fault elimination

Events, causes and remedies
Causes and remedies



805311445 | 0x300013D5 CoE - SDO Abort 'General parameter incompatibility (0x06040043)'

Cause	Remedy	Severity/response
Access denied.	Check access authorization.	Information

805311446 | 0x300013D6 CoE - SDO Abort 'General internal incompatibility in the device (0x06040047)'

Cause	Remedy	Severity/response
Access denied.	Check access authorization.	Information

805311447 | 0x300013D7 CoE - SDO Abort 'Access failed due to an hardware error (0x06060000)'

Cause	Remedy	Severity/response
Access denied.	Check access authorization. Check object properties.	Information

805311448 | 0x300013D8 CoE - SDO Abort 'Data type or length of service parameters do not match (0x06070010)'

Cause	Remedy	Severity/response
Access denied.	Check access authorization. Check object properties.	Information

805311449 | 0x300013D9 CoE - SDO Abort 'Data type does not match, service parameter too high (0x06070012)'

Cause	Remedy	Severity/response
Access denied.	Check access authorization. Check object properties.	Information

805311450 | 0x300013DA CoE - SDO Abort 'Data type does not match, service parameter too low (0x06070013)'

Cause	Remedy	Severity/response
Access denied.	Check access authorization. Check object properties.	Information

805311451 | 0x300013DB CoE - SDO Abort 'Subindex does not exist (0x06090011)'

Cause	Remedy	Severity/response
Access denied.	Check access authorization. Check object properties.	Information

805311452 | 0x300013DC CoE - SDO Abort 'Write access - Parameter value exceeds limits (0x06090030)'

Cause	Remedy	Severity/response
Access denied.	Check access authorization. Check object properties.	Information

805311453 | 0x300013DD CoE - SDO Abort 'Write access - Parameter value too high (0x06090031)'

Cause	Remedy	Severity/response
Access denied.	Check access authorization. Check object properties.	Information



Diagnostics and fault elimination

Events, causes and remedies
Causes and remedies

805311454 | 0x300013DE CoE - SDO Abort 'Write access - Parameter value too low (0x06090032)'

Cause	Remedy	Severity/response
Access denied.	Check access authorization. Check object properties.	Information

805311455 | 0x300013DF CoE - SDO Abort 'Maximum value less than minimum value (0x06090036)'

Cause	Remedy	Severity/response
Access denied.	Check access authorization. Check object properties.	Information

805311456 | 0x300013E0 CoE - SDO Abort 'General error (0x08000000)'

Cause	Remedy	Severity/response
Access denied.	Check access authorization. Check object properties.	Information

805311457 | 0x300013E1 CoE - SDO Abort 'Data cannot be transferred/stored in application (0x08000020)'

Cause	Remedy	Severity/response
Access denied.	Check access authorization. Check object properties.	Information

805311458 | 0x300013E2 CoE - SDO Abort 'Local control - Data cannot be transferred/stored in application (0x08000021)'

Cause	Remedy	Severity/response
Access denied.	Check access authorization. Check object properties.	Information

805311459 | 0x300013E3 CoE - SDO Abort 'Actual device state - Data cannot be transferred/stored in application (0x08000022)'

Cause	Remedy	Severity/response
Access denied.	Check access authorization. Check object properties.	Information

805311460 | 0x300013E4 CoE - SDO Abort 'Object dictionary - Dynamic generation fails or object dictionary is missing (0x08000023)'

Cause	Remedy	Severity/response
Access denied.	Check access authorization. Check object properties.	Information

805311461 | 0x300013E5 CoE - SDO Abort 'Unknown abort code'

Cause	Remedy	Severity/response
Access denied.	Check access authorization. Check object properties.	Information

805311462 | 0x300013E6 CoE - Invalid parameter

Cause	Remedy	Severity/response
Access denied.	Check access authorization. Check object properties. Check transfer properties.	Information

Diagnostics and fault elimination

Events, causes and remedies
Causes and remedies



805311463 | 0x300013E7 **CoE - CoE protocol not supported**

Cause	Remedy	Severity/response
Access denied.	Check access authorization. Check object properties. Check transfer properties.	Information

805311464 | 0x300013E8 **CoE - Unknown FoE error**

Cause	Remedy	Severity/response
Access denied.	Check access authorization. Check file. Check transfer properties.	Information

805311465 | 0x300013E9 **CoE - FoE error 'Not found'**

Cause	Remedy	Severity/response
Access denied.	Check access authorization. Check file. Check transfer properties.	Information

805311466 | 0x300013EA **CoE - FoE error 'Access denied'**

Cause	Remedy	Severity/response
Access denied.	Check access authorization. Check file. Check transfer properties.	Information

805311467 | 0x300013EB **CoE - FoE error 'Disk full'**

Cause	Remedy	Severity/response
Access denied.	Check access authorization. Check file. Check transfer properties.	Information

805311468 | 0x300013EC **CoE - FoE error 'Illegal'**

Cause	Remedy	Severity/response
Access denied.	Check access authorization. Check file. Check transfer properties.	Information

805311469 | 0x300013ED **CoE - FoE error 'Wrong packet number'**

Cause	Remedy	Severity/response
Access denied.	Check access authorization. Check object properties.	Information

805311470 | 0x300013EE **CoE - FoE error 'Already existing'**

Cause	Remedy	Severity/response
Access denied.	Check access authorization. Check file. Check transfer properties.	Information



Diagnostics and fault elimination

Events, causes and remedies
Causes and remedies

805311471 | 0x300013EF **CoE - FoE error 'User missing'**

Cause	Remedy	Severity/response
Access denied.	Check access authorization. Check file. Check transfer properties.	Information

805311472 | 0x300013F0 **CoE - FoE error 'Only possible in bootstrap'**

Cause	Remedy	Severity/response
Access denied.	Check access authorization. Check file. Check transfer properties.	Information

805311473 | 0x300013F1 **CoE - FoE error 'No bootstrap'**

Cause	Remedy	Severity/response
Access denied.	Check access authorization. Check file. Check transfer properties.	Information

805311474 | 0x300013F2 **CoE - FoE error 'No access rights'**

Cause	Remedy	Severity/response
Access denied.	Check access authorization. Check file. Check transfer properties.	Information

805311475 | 0x300013F3 **CoE - FoE error 'Program error'**

Cause	Remedy	Severity/response
Access denied.	Check access authorization. Check object properties.	Information

805311476 | 0x300013F4 **CoE - FoE error 'Invalid parameter'**

Cause	Remedy	Severity/response
Access denied.	Check access authorization. Check file. Check transfer properties.	Information

805311881 | 0x30001589 **EtherCAT - State change of master successful**

Cause	Remedy	Severity/response
EtherCAT - State change of master successful	For information only. No remedy necessary.	Fault

805311882 | 0x3000158A **EtherCAT - Bus scan successful**

Cause	Remedy	Severity/response
EtherCAT - Bus scan successful	For information only. No remedy necessary.	Fault

Diagnostics and fault elimination

Events, causes and remedies
Causes and remedies



805311883 | 0x3000158B EtherCAT - Bus scan error

Cause	Remedy	Severity/response
Error in the network topology	Check network topology.	Fault

805311892 | 0x30001594 CoE - Emergency request

Cause	Remedy	Severity/response
Internal error during transmission of emergency messages.	Check the documentation of the slave device for this emergency message. Note: "data: ..." shows by codes which error has occurred in which slave device/module. Detailed information about the coding of error messages can be found in the documentation of the corresponding slave device/module.	Information

805311893 | 0x30001595 Cyclic command WKC error

Cause	Remedy	Severity/response
WKC error	Check slave status. Check network topology.	Fault

805311894 | 0x30001596 Master init command WKC error

Cause	Remedy	Severity/response
WKC error	Check slave status. Check network topology.	Warning

805311895 | 0x30001597 Slave init command WKC error

Cause	Remedy	Severity/response
WKC error	Check slave status. Check network topology.	Warning

805311896 | 0x30001598 EoE receive WKC error

Cause	Remedy	Severity/response
WKC error	Check slave status. Check network topology.	Warning

805311897 | 0x30001599 CoE receive WKC error

Cause	Remedy	Severity/response
WKC error	Check slave status. Check network topology.	Warning

805311898 | 0x3000159A FoE receive WKC error

Cause	Remedy	Severity/response
WKC error	Check slave status. Check network topology.	Fault



805311900 | 0x3000159C **EoE send WKC error**

Cause	Remedy	Severity/response
WKC error	Check slave status. Check network topology.	Warning

805311901 | 0x3000159D **CoE send WKC error**

Cause	Remedy	Severity/response
WKC error	Check slave status. Check network topology.	Warning

805311902 | 0x3000159E **FoE send WKC error**

Cause	Remedy	Severity/response
WKC error	Check slave status. Check network topology.	Warning

805311909 | 0x300015A5 **Init command response error - No response**

Cause	Remedy	Severity/response
Internal error	Restart the device. If the error persists, contact the manufacturer.	Warning

805311910 | 0x300015A6 **Init command response error - Validation error**

Cause	Remedy	Severity/response
Internal error	Restart the device. If the error persists, contact the manufacturer.	Warning

805311911 | 0x300015A7 **Init command response error - Failed**

Cause	Remedy	Severity/response
Internal error	Restart the device. If the error persists, contact the manufacturer.	Warning

805311912 | 0x300015A8 **Master init command response error - No response**

Cause	Remedy	Severity/response
Internal error	Restart the device. If the error persists, contact the manufacturer.	Warning

805311913 | 0x300015A9 **Master init command response error - Validation error**

Cause	Remedy	Severity/response
Internal error	Restart the device. If the error persists, contact the manufacturer.	Warning

805311915 | 0x300015AB **Mailbox init command timeout**

Cause	Remedy	Severity/response
Internal error	Restart the device. If the error persists, contact the manufacturer.	Warning

Diagnostics and fault elimination

Events, causes and remedies
Causes and remedies



805311916 | 0x300015AC **At least one EtherCAT slave not in 'Operational'**

Cause	Remedy	Severity/response
Master is "Operational". At least one slave is not "Operational".	Check slave status. Check network topology.	Warning

805311917 | 0x300015AD **EtherCAT cable connected**

Cause	Remedy	Severity/response
EtherCAT cable connected	For information only. No remedy necessary.	Information

805311918 | 0x300015AE **EtherCAT cable not connected**

Cause	Remedy	Severity/response
Network cabling is faulty.	Check network cabling.	Information

805311921 | 0x300015B1 **At least one slave is in state 'Error'**

Cause	Remedy	Severity/response
At least one slave is in the "Error" state.	Check slave status. Check network topology.	Warning

805311922 | 0x300015B2 **Slave error**

Cause	Remedy	Severity/response
A slave reports an error.	Analyze detailed error message in the logbook. Check slave status. Check network topology.	Warning

805311923 | 0x300015B3 **Communication to device interrupted**

Cause	Remedy	Severity/response
The connection to the slave is interrupted. The slave does not respond. The slave is no longer available.	Check slave status. Check network topology.	Warning

805311924 | 0x300015B4 **SDO abort**

Cause	Remedy	Severity/response
CoE access denied.	Analyze detailed error message in the logbook. Check object properties. Check transfer properties.	Warning

805311925 | 0x300015B5 **DC slaves are 'in-sync'**

Cause	Remedy	Severity/response
DC slaves are 'in-sync'	For information only. No remedy necessary.	Information

805311926 | 0x300015B6 **DC slaves are 'out-of-sync'**

Cause	Remedy	Severity/response
The DC deviation is outside the permissible limits.	Check slave status. Check slave properties. Check network topology.	Warning



805312086 | 0x30001656 **Communication to device interrupted**

Cause	Remedy	Severity/response
Communication interruption	Check slave status. Check network topology.	Information

805312087 | 0x30001657 **Slave is not in expected status**

Cause	Remedy	Severity/response
Detected slave status differs from expected slave status.	Analyze detailed error message in the logbook. Check slave status. Check network topology.	Warning

805312112 | 0x30001670 **Bus scan timeout**

Cause	Remedy	Severity/response
The bus scan was aborted due to timeout.	Analyze detailed error message in the logbook. Check network topology.	Warning

805312568 | 0x30001838 **Configuration error - Check of VendorID failed**

Cause	Remedy	Severity/response
The vendor ID could not be checked.	Analyze detailed error message in the logbook. Check network topology.	Warning

805312569 | 0x30001839 **Configuration error - Check of ProductCode failed**

Cause	Remedy	Severity/response
The product code could not be checked.	Analyze detailed error message in the logbook. Check network topology.	Information

805312570 | 0x3000183A **Configuration error - Check of Revision failed**

Cause	Remedy	Severity/response
The revision could not be checked.	Analyze detailed error message in the logbook. Check network topology.	Information

805312571 | 0x3000183B **Configuration error - Check of VendorID failed**

Cause	Remedy	Severity/response
The vendor ID could not be checked.	Analyze detailed error message in the logbook. Check network topology.	Information

805312572 | 0x3000183C **Configuration error - Odd device at bus end**

Cause	Remedy	Severity/response
A surplus device was detected at the end of the bus.	Analyze detailed error message in the logbook. Check network topology.	Information

805312578 | 0x30001842 **Internal error counter resetted**

Cause	Remedy	Severity/response
Internal error counter resetted	For information only. No remedy necessary.	Information

Diagnostics and fault elimination

Events, causes and remedies
Causes and remedies



805312580 | 0x30001844 **All slaves 'Operational' again**

Cause	Remedy	Severity/response
All slaves 'Operational' again	For information only. No remedy necessary.	Information

805312581 | 0x30001845 **Cyclic command WKC error**

Cause	Remedy	Severity/response
WKC error	Analyze detailed error message in the logbook. Check slave status. Check network topology.	Warning

805312582 | 0x30001846 **Frame response error**

Cause	Remedy	Severity/response
Frame response error	Analyze detailed error message in the logbook. Check slave status. Check network topology.	Warning

805312583 | 0x30001847 **Not all slaves are 'Operational'**

Cause	Remedy	Severity/response
Not all slaves have been set to 'Operational'.	Analyze detailed error message in the logbook. Check slave status. Check network topology.	Information

805312584 | 0x30001848 **Emergency message - Overflow, further messages blocked**

Cause	Remedy	Severity/response
Too many emergency messages.	Check if slave sends too many emergency messages. Eliminate cause.	Warning

805312588 | 0x3000184C **New configuration loaded**

Cause	Remedy	Severity/response
New configuration loaded	For information only. No remedy necessary.	Information

805312589 | 0x3000184D **New configuration loaded, no slaves defined**

Cause	Remedy	Severity/response
New configuration loaded, no slaves defined	For information only. No remedy necessary.	Information

805312590 | 0x3000184E **Master - Start failed, configuration error**

Cause	Remedy	Severity/response
Internal error	Check slave status. Check network topology.	Information

805312591 | 0x3000184F **New configuration loaded from slaves EEPROM**

Cause	Remedy	Severity/response
A new configuration has been loaded from the EEPROMs of the slaves.	For information only. No remedy necessary.	Information



Diagnostics and fault elimination

Events, causes and remedies
Causes and remedies

805312598 | 0x30001856 **Master - Start failed**

Cause	Remedy	Severity/response
Internal error	Check slave status. Check network topology.	Warning

805312599 | 0x30001857 **Master - Start failed, bus configuration error**

Cause	Remedy	Severity/response
Bus configuration error	Check network topology.	Warning

805312600 | 0x30001858 **Master - Start failed, EtherCAT cable disconnected**

Cause	Remedy	Severity/response
Network cabling is faulty.	Check network cabling.	Warning

805312601 | 0x30001859 **Master - Start failed, DC/DCM configuration**

Cause	Remedy	Severity/response
The master cannot be started due to a faulty DC/DCM configuration.	Check slave configuration.	Warning

805312602 | 0x3000185A **Master - Start failed, cannot set slaves to 'Pre-Operational'**

Cause	Remedy	Severity/response
Slaves cannot be set to 'Pre-Operational'.	Check slave configuration.	Warning

805312608 | 0x30001860 **Master - Set 'Operational' failed**

Cause	Remedy	Severity/response
'Operational' could not be set.	Check slave configuration.	Warning

805312610 | 0x30001862 **Master - Set 'Operational' failed, EtherCAT cable disconnected**

Cause	Remedy	Severity/response
Network cabling is faulty.	Check network cabling.	Warning

805312613 | 0x30001865 **Master - Set 'Operational' takes some time...**

Cause	Remedy	Severity/response
Master - Set 'Operational' takes some time...	For information only. No remedy necessary.	Warning

805312614 | 0x30001866 **Master - Set 'Operational' failed, time-out**

Cause	Remedy	Severity/response
Internal error	Check slave status. Check network topology.	Warning

Diagnostics and fault elimination

Events, causes and remedies
Causes and remedies



805312615 | 0x30001867 **Master - Set 'Operational' failed, slave error**

Cause	Remedy	Severity/response
Slave error	Analyze previous error message (slave error) in the logbook. Check slave status. Check network topology.	Warning

805312616 | 0x30001868 **Master - Set 'Operational' aborted by reset command**

Cause	Remedy	Severity/response
Master - Set 'Operational' aborted by reset command	For information only. No remedy necessary.	Warning

805312618 | 0x3000186A **Master - Stopping failed**

Cause	Remedy	Severity/response
Master cannot be stopped.	For information only. No remedy required.	Warning

805312619 | 0x3000186B **Master - Stopping failed, cannot set Slaves 'Pre-Operational'**

Cause	Remedy	Severity/response
Slave error	For information only. No remedy required.	Warning

805312628 | 0x30001874 **Master - Shutdown failed**

Cause	Remedy	Severity/response
Master - Shutdown failed	For information only. No remedy necessary.	Warning

805312638 | 0x3000187E **Remote API Server - Start failed**

Cause	Remedy	Severity/response
Internal error	Restart the device. If the error persists, contact the manufacturer.	Warning

805312648 | 0x30001888 **Start Download Service**

Cause	Remedy	Severity/response
Start Download Service	For information only. No remedy necessary.	Information

805312649 | 0x30001889 **Download Service done**

Cause	Remedy	Severity/response
Download Service done	For information only. No remedy necessary.	Information

805312668 | 0x3000189C **MMC - Internal error**

Cause	Remedy	Severity/response
Internal error	Restart the device. If the error persists, contact the manufacturer.	Warning



Diagnostics and fault elimination

Events, causes and remedies
Causes and remedies

805312669 | 0x3000189D **MMC - 'Modular Machine Configuration' is active**

Cause	Remedy	Severity/response
MMC - "Modular Machine Configuration" is active.	For information only. No remedy necessary.	Information

805312670 | 0x3000189E **MMC - Service started**

Cause	Remedy	Severity/response
MMC - Service started	For information only. No remedy necessary.	Information

805312671 | 0x3000189F **MMC - Service stopped**

Cause	Remedy	Severity/response
MMC - Service stopped	For information only. No remedy necessary.	Information

805312672 | 0x300018A0 **MMC - Error in configuration files**

Cause	Remedy	Severity/response
MMC configuration file is faulty.	Check MMC configuration file.	Warning

805312673 | 0x300018A1 **MMC - File does not exist**

Cause	Remedy	Severity/response
MMC - File does not exist	For information only. No remedy necessary.	Warning

805312674 | 0x300018A2 **MMC - Parsing error**

Cause	Remedy	Severity/response
MMC configuration file is faulty.	Check MMC configuration file.	Warning

805312675 | 0x300018A3 **MMC - parsing of file successful**

Cause	Remedy	Severity/response
MMC - parsing of file successful	For information only. No remedy necessary.	Warning

805312676 | 0x300018A4 **MMC - Devices not sorted in ascending order or devices missing**

Cause	Remedy	Severity/response
MMC configuration file is faulty.	Check MMC configuration file.	Warning

805312677 | 0x300018A5 **MMC - Number of devices in device tree differs**

Cause	Remedy	Severity/response
MMC configuration file is faulty.	Check MMC configuration file. Check network topology.	Warning

805312678 | 0x300018A6 **MMC - Device type mismatch for Alias Address**

Cause	Remedy	Severity/response
MMC configuration file is faulty.	Check MMC configuration file. Analyze detailed error message in the logbook.	Warning

Diagnostics and fault elimination

Events, causes and remedies
Causes and remedies



805312679 | 0x300018A7 MMC - Invalid Alias Address

Cause	Remedy	Severity/response
Incorrect alias address.	Check SSA addresses of the slaves. Analyze detailed error message in the logbook.	Warning

805312680 | 0x300018A8 MMC - Duplicated Alias Address

Cause	Remedy	Severity/response
Double alias address.	Check SSA addresses of the slaves. Analyze detailed error message in the logbook.	Warning

805312681 | 0x300018A9 MMC - No configuration checks

Cause	Remedy	Severity/response
MMC - No configuration checks	For information only. No remedy necessary.	Information

805312682 | 0x300018AA MMC - Invalid configuration

Cause	Remedy	Severity/response
Internal error	Restart the device. If the error persists, contact the manufacturer.	Warning

805312683 | 0x300018AB MMC - Mandatory slave missing

Cause	Remedy	Severity/response
MMC configuration file is faulty. Network topology is faulty.	Check MMC configuration file. Check network topology.	Warning

805312684 | 0x300018AC MMC - Optional slave is present, but not allowed

Cause	Remedy	Severity/response
MMC configuration file is faulty. Network topology is faulty.	Check MMC configuration file. Check network topology.	Warning

805312685 | 0x300018AD MMC - No valid service active

Cause	Remedy	Severity/response
MMC - No valid service active	For information only. No remedy necessary.	Warning

805312686 | 0x300018AE MMC - Address assignment error, less slaves connected than configured

Cause	Remedy	Severity/response
MMC configuration file is faulty. Network topology is faulty.	Analyze detailed error message in the logbook. Check MMC configuration file. Check network topology.	Warning

805312687 | 0x300018AF MMC - Address assignment error, more slaves connected than configured

Cause	Remedy	Severity/response
MMC configuration file is faulty. Network topology is faulty.	Analyze detailed error message in the logbook. Check MMC configuration file. Check network topology.	Fault



805312688 | 0x300018B0 **MMC - Address assignment error, invalid device**

Cause	Remedy	Severity/response
MMC configuration file is faulty. Network topology is faulty.	Analyze detailed error message in the logbook. Check MMC configuration file. Check network topology.	Fault

805312689 | 0x300018B1 **MMC - Address assignment successful**

Cause	Remedy	Severity/response
MMC - Address assignment successful	For information only. No remedy necessary.	Information

805312690 | 0x300018B2 **MMC - Address assignment failed**

Cause	Remedy	Severity/response
MMC configuration file is faulty. Network topology is faulty.	Analyze detailed error message in the logbook. Check MMC configuration file. Check network topology.	Information

805312691 | 0x300018B3 **MMC - Address assignment done**

Cause	Remedy	Severity/response
MMC - Address assignment done	For information only. No remedy necessary.	Information

805312692 | 0x300018B4 **MMC - Address assignment error, writing address by CoE**

Cause	Remedy	Severity/response
MMC - Address assignment error, writing address by CoE	For information only. No remedy necessary.	Warning

805312693 | 0x300018B5 **MMC - Slave identification error**

Cause	Remedy	Severity/response
MMC configuration file is faulty. Network topology is faulty.	Analyze detailed error message in the logbook. Check MMC configuration file. Check network topology.	Warning

805312694 | 0x300018B6 **MMC - Slave identification error, slave ident data failed**

Cause	Remedy	Severity/response
MMC configuration file is faulty. Network topology is faulty.	Analyze detailed error message in the logbook. Check MMC configuration file. Check network topology.	Warning

805312695 | 0x300018B7 **MMC - Service state cannot be changed, set bus to 'INIT' first**

Cause	Remedy	Severity/response
Service request rejected because master not in "Init" status	Check status of the master. Set status of the master to "Init".	Information

Diagnostics and fault elimination

Events, causes and remedies
Causes and remedies



805312768 | 0x30001900 **CoE - Emergency request**

Cause	Remedy	Severity/response
Internal error during transmission of emergency messages.	Check the documentation of the slave device for this emergency message. Note: "data: ..." shows by codes which error has occurred in which slave device/module. Detailed information about the coding of error messages can be found in the documentation of the corresponding slave device/module.	Information

822310534 | 0x31037686 **Network - Configuration error**

Cause	Remedy	Severity/response
Network option incorrectly plugged in or not plugged in. Network option in PLC project does not match configured network option.	<ul style="list-style-type: none"> Use the type code to check whether the network option used is correct. Compare the network option configured in the PLC project with the network option configured in the controller (see parameter 0x231F:xxx). 	Fault

822313360 | 0x31038190 **Network - Watchdog time-out**

Cause	Remedy	Severity/response
Permanent interruption of communication to the PLC.	<ul style="list-style-type: none"> Check wiring of the network. Eliminate EMC interferences. Check cables and connections. Plug Ethernet cable into RJ45 sockets X2x6/X2x7. 	Trouble (configurable)
		Setting parameters: 0x2859:001

822313361 | 0x31038191 **Network - Disruption of cyclic data exchange**

Cause	Remedy	Severity/response
Permanent interruption of communication to the PLC.	<ul style="list-style-type: none"> Check cables and connections. Plug Ethernet cable into RJ45 sockets X2x6/X2x7. 	No response (configurable)
		Setting parameters: 0x2859:002

822313362 | 0x31038192 **Network - Initialization error**

Cause	Remedy	Severity/response
Network option was parameterized with wrong values.	<ul style="list-style-type: none"> Check station name. Check IP configuration. Check other parameters of the network option. 	Trouble (configurable)
		Setting parameters: 0x2859:004

822313363 | 0x31038193 **Network - Invalid cyclic process data**

Cause	Remedy	Severity/response
Process data marked invalid by the network option is sent.	<ul style="list-style-type: none"> Check whether the PLC is in the "STOP" state. Check cables and connections. Plug Ethernet cable into RJ45 sockets X2x6/X2x7. 	Trouble (configurable)
		Setting parameters: 0x2859:005



822313607 | 0x31038287 **Network - Invalid configuration**

Cause	Remedy	Severity/response
A module or submodule does not correspond to the configuration of the IO controller.	Check/correct configuration.	Trouble (configurable) Setting parameters: 0x2859:003

822313608 | 0x31038288 **Network - Max. count of supported process data reached**

Cause	Remedy	Severity/response
The maximum supported number/size of configurable PDOs has been exceeded.	Decrease the number or size of the configured PDOs. The maximum number and size of PDOs can be found in the documentation.	Fault

827331073 | 0x31501201 **Address space update failed**

Cause	Remedy	Severity/response
The address area could not be updated.	In the "PLC Designer" reduce the number of symbols in the symbol configuration.	Warning

827331074 | 0x31501202 **Client user authentication failed**

Cause	Remedy	Severity/response
Client user authentication has failed.	Check in the "PLC Designer" in the user management whether user and associated password are available.	Warning

827331075 | 0x31501203 **Client operation failed**

Cause	Remedy	Severity/response
The client operation has failed.	Check client operation and its arguments against the meaning of the present OPC UA status code. http://www.opcfoundation.org/UA/schemas/StatusCode.csv	Warning

827331078 | 0x31501206 **Client has been rejected because the certificate is not trusted**

Cause	Remedy	Severity/response
A client connection was not established because the client certificate is not trusted.	Open the security screen in the "PLC Designer" and check the certificates. Trust or update certificate	Warning

827331329 | 0x31501301 **Out of memory**

Cause	Remedy	Severity/response
Not enough memory.	In the "PLC Designer" reduce the number of symbols in the symbol configuration.	Fault

827331330 | 0x31501302 **Failed to update address space**

Cause	Remedy	Severity/response
The address area could not be updated.	In the "PLC Designer" reduce the number of symbols in the symbol configuration.	Fault

Technical data

Standards and operating conditions
Conformities and approvals



15 Technical data

15.1 Standards and operating conditions

15.1.1 Conformities and approvals

Conformities		
CE	2014/30/EU	EMC Directive Applied standards: EN 61000-6-2:2005 + AC:2005 EN IEC 61000-6-2:2019 EN 61000-6-4:2007 + A1:2011 EN IEC 61000-6-4:2019 EN 55032:2015 + A11:2020 EN 55035:2017 + A11:2020
	2011/65/EU	RoHS Directive Applied harmonised standards: EN IEC 63000:2018
UKCA	S.I. 2016/1091	The Electromagnetic Compatibility Regulations 2016
	S.I. 2012/3032	The Restriction of the Use of Certain Hazardous Substances in Electrical and Electronic Equipment Regulations 2012
UL	UL 61010-1	Process Control Equipment
	UL/CSA 61010-2-201	

15.1.2 Protection of persons and device protection

Protection of persons and device protection		
Degree of protection	EN 60529	IP 20
Electrical isolation		
To the fieldbus		Depending on the fieldbus network used
PE-GND		110 VDC
PE-24V		110 VDC
Protective measure		Internal polarity reversal protection against short circuit/overvoltage

15.1.3 EMC data

EMC		
Interference emission	EN 61000-6-4	Class A (industrial premises) interference radiation (30...6 GHz) 7.3 of CISPR 16-2-3 +A1 +A2 2010/2014
	EN 61000-6-3	Class A (industrial premises) conducted interference (0.15...30 MHz) EN 55022:2010/AC:2011
Immunity to interference	EN 61000-6-2	Industrial premises
	IEC 61000-4-2	Immunity to interference against the discharge of static electricity EN61000-4-2 2009 ESD; severity 3, i.e. 8 kV with air discharge, 4 kV with contact discharge
	IEC 61000-4-3	Immunity to interference against high-frequency electromagnetic fields EN61000-4-3 +A1 +A2 2006/2008/2010 RF interference (housing) 80 MHz ... 1000 MHz, 10 V/m 80 % AM (1 kHz)
	IEC 61000-4-4	Immunity to interference against fast, transient electrical interference/burst EN61000-4-4 +A1 2004/2010 burst, severity 3
	IEC 61000-4-5	Immunity to interference against fast transients EN61000-4-5 2006 surge, severity 1
	IEC 61000-4-6	Immunity to interference against conducted interference EN61000-4-6 2009 150 kHz ... 80 MHz, 10 V/m 80 % AM (1 kHz)



15.1.4 Environmental conditions

Ambient conditions		
Climatic		
Storage/transport	EN 60721-3-2	2K3: -25 ... +60 °C
Operation	EN 60721-3-2	3K3: c520: 0°C to 60°C for horizontal installation c550/c750 (with fan): 0°C to 60°C for horizontal installation Note: The buffer time of the RTC is designed for four weeks. Depending on the ambient temperature, the buffer time may be derated.
Air humidity	EN 60721-3-3	2K3 (without condensation, relative humidity 10 ... 95 %)
Pollution	EN 61010-1	Pollution degree 2
Mechanical		
Shock/vibration	IEC 61131-2:2007 (sine, shock) EN 60721-3-3 3M5	Vibration in accordance with IEC 60068-2-6, test Fc: <ul style="list-style-type: none"> • 5 Hz - 8.4 Hz - deflection 3.5mm • 8.4 Hz - 200 Hz 1 g acceleration • Rate of change 1 octave/min • 10 frequency cycles per axis (also covers the test in compliance with EN 60721-3-3 class 3M5) Shock complying with the specifications of IEC 60068-2-27 <ul style="list-style-type: none"> • Test Ea: half-sine • 15 g • 11 ms • Half-sine • 25 g • 6 ms duration • 3 shocks per axis for each direction (a total of 18 shocks) • 2 Hz - 13.2 Hz - deflection +/-1mm • 13.2 Hz - 100 Hz 0.7 g acceleration • Rate of change 1 octave/min, runtime depending on the resonance point determination
Site altitude		
Storage/transport		< 12000 m amsl
Operation		< 3000 m amsl



15.2 Rated data

Voltage [V DC]	Stand-alone		With I/O system 1000 in maximum configuration	
	Current [A]	Power* [W]	Current [A]	Power [W]
24 (+18 ... +30)	1.75	31	2.75	50

Tab. 3: * Power without network option and without USB consumer

	Voltage [V] DC	Max. current [A]
USB1/USB2 (X61/X62)	5	0.5
Backplane bus I/O system 1000	5	2



16 Environmental notes and recycling

Lenze has been certified to the worldwide environmental management standard for many years (DIN EN ISO 14001). As part of our environmental policy and the associated climate responsibility, please note the following information on hazardous ingredients and the recycling of Lenze products and their packaging:



Lenze products are partly subject to the EU Directive on the restriction of certain hazardous substances in electrical and electronic equipment 2011/65/EU: RoHS Directive [UKCA: S.I. 2012/3032 - The Restriction of the Use of Certain Hazardous Substances in Electrical and Electronic Equipment Regulations 2012] . This is documented accordingly in the EU declaration of conformity and with the CE mark.



Lenze products are not subject to EU Directive 2012/19/EU: Directive on waste electrical and electronic equipment (WEEE) [UKCA: S.I. 2013/3113 - The Waste Electrical and Electronic Equipment Regulations 2013] , but some contain batteries/rechargeable batteries in accordance with EU Directive 2006/66/EC: Battery Directive [UKCA: S.I. 2009/890 - The Waste Batteries and Accumulators Regulations 2009] . The disposal route, which is separate from household waste, is indicated by corresponding labels with the "crossed-out trash can".

Any batteries/rechargeable batteries included are designed to last the life of the product and do not need to be replaced or otherwise removed by the end user.



Lenze products are usually sold with cardboard or plastic packaging. This packaging complies with EU Directive 94/62/EC: Directive on packaging and packaging waste [UKCA: S.I. 1997/648 - The Producer Responsibility Obligations (Packaging Waste) Regulations 1997] . The required disposal route is indicated by material-specific labels with the "recycling triangle".

Example: "21 - other cardboard"

REACH

Lenze products are subject to REGULATION (EC) No 1907/2006: REACH Regulation [UKCA: S.I. 2008/2852 - The REACH Enforcement Regulations 2008] . When used as intended, exposure of substances to humans, animals and the environment is excluded.

Lenze products are industrial electrical and electronic products and are disposed of professionally. Both the mechanical and electrical components such as electric motors, gearboxes or inverters contain valuable raw materials that can be recycled and reused. Proper recycling and thus maintaining the highest possible level of recyclability is therefore important and sensible from an economic and ecological point of view.

- Coordinate professional disposal with your waste disposal company.
- Separate mechanical and electrical components, packaging, hazardous waste (e.g. gear oils) and batteries/rechargeable batteries wherever possible.
- Dispose of the separated waste in an environmentally sound and proper manner (no household waste or municipal bulky waste).

What?	Material	Disposal instructions
Pallets	Wood	Return to manufacturers, freight forwarders or reusable materials collection system
Packaging material	Paper, cardboard, pasteboard, plastics	Collect and dispose of separately
Products		
Electronic devices	Metal, plastics, circuit boards, heatsinks	As electronic waste give to professional disposer for recycling
Gearbox	Oil	Drain oil and dispose of separately
	Casting, steel, aluminium	Dispose as metal scrap
Motors	Casting, copper, rotors, magnets, potting compound	As engine scrap give to professional disposer for recycling
Dry-cell batteries/rechargeable batteries		As used batteries give to professional disposer for recycling



Further information on Lenze's environmental and climate responsibility and on the topic of energy efficiency can be found on the Internet:

www.Lenze.com → search word: "Sustainability"



17 Appendix

17.1 Parameter attribute list

- The parameter attribute list contains all parameters of the controller.
- The parameter attribute list is sorted by addresses (index:subindex) in ascending order.

How to read the parameter attribute list:

Column	Meaning		
Address	Address of the parameter in the object directory. Format: Index:Subindex		
Name	Parameter name		
Default setting	Default setting of the parameter		
Data type	Data type of the parameter:		
	I16	INTEGER_16	2 bytes with sign
	I32	INTEGER_32	4 bytes with sign
	U8	UNSIGNED_8	1 byte without sign
	U16	UNSIGNED_16	2 bytes without sign
	U32	UNSIGNED_32	4 bytes without sign
	U64	UNSIGNED_64	8 bytes without sign
	STRING[xx]	VISIBLE_STRING	ASCII string (with character length xx)
OCTET[xx]	OCTET_STRING	OCTET string (with xx bytes)	

Parameter attribute list (short overview of all parameter indexes)

Address	Name	Default setting	Data type
0x1000	Device type	- (Read only)	U32
0x1008	Manufacturer device name	- (Read only)	STRING[50]
0x1009	Manufacturer hardware version	- (Read only)	STRING[50]
0x100A	Manufacturer software version	- (Read only)	STRING[50]
0x1018:001	Identity object: Vendor ID	- (Read only)	U32
0x1018:002	Identity object: Product ID	- (Read only)	U32
0x1018:003	Identity object: Revision number	- (Read only)	U32
0x1018:004	Identity object: Serial number	- (Read only)	U32
0x2000:001	Device data: Product code	- (Read only)	STRING[50]
0x2000:002	Device data: Serial number	- (Read only)	STRING[50]
0x2000:003	Device data: Production date	- (Read only)	STRING[50]
0x2000:004	Device data: CU firmware version	- (Read only)	STRING[50]
0x2000:006	Device data: CU bootloader version	- (Read only)	STRING[50]
0x2000:020	Device data: CPU name	- (Read only)	STRING[50]
0x2001	Device name	"My Device"	STRING[128]
0x2002:006	Device module: CU serial number	- (Read only)	STRING[50]
0x2002:010	Device module: Type communication module	- (Read only)	STRING[50]
0x2002:011	Device module: Serial number communication module	- (Read only)	STRING[50]
0x2002:012	Device module: Hardware version communication module	- (Read only)	STRING[50]
0x2002:020	Device module: Driver version	- (Read only)	STRING[50]
0x2010:001	Device event monitor: EreignisortEvent location	- (Read only)	U8
0x2010:002	Device event monitor: Severity	- (Read only)	U8
0x2010:003	Device event monitor: Event status	- (Read only)	U8
0x2010:005	Device event monitor: Number of current event	- (Read only)	U32
0x2010:006	Device event monitor: Time stamp of current event	- (Read only)	U32
0x2012:001	Device information: SD card status	- (Read only)	U8
0x2012:002	Device information: Application Credit available	- (Read only)	U16
0x2012:003	Device information: Dual use licence	- (Read only)	U8
0x2012:004	Device information: SD card total memory	- (Read only)	U32
0x2012:005	Device information: SD card free memory	- (Read only)	U32
0x2012:006	Device information: SD card used memory	x kB (Read only)	U32
0x2012:007	Device information: License information	- (Read only)	STRING[32]



Address	Name	Default setting	Data type
0x2013:001	Application information: Active application	- (Read only)	U16
0x2013:002	Application information: Application Credit required	- (Read only)	U16
0x2014:001	General network identification: Hostname	- (Read only)	STRING[128]
0x2021:001	Optical tracking: Start detection	Stop [0]	U8
0x2021:002	Optical tracking: Blinking duration	5 s	U16
0x2022:001	Device commands: Load default settings	Off / ready [0]	U8
0x2022:003	Device commands: Save user data	Off / ready [0]	U8
0x2022:015	Device commands: Delete logbook	Off / ready [0]	U8
0x2022:035	Device commands: Restart Device	Off / ready [0]	U8
0x2022:036	Device commands: Export Logbook	Off / ready [0]	U8
0x2022:037	Device commands: Delete Logfiles	Off / ready [0]	U8
0x2022:039	Device commands: Load TA default settings	Off / ready [0]	U8
0x2022:040	Device commands: Parameter-Backup	Off / ready [0]	U8
0x2022:043	Device commands: Restore	Off / ready [0]	U8
0x2022:044	Device commands: Start application	Off / ready [0]	U8
0x2022:045	Device commands: Stop application	Off / ready [0]	U8
0x2022:046	Device commands: Reload boot project	Off / ready [0]	U8
0x2022:047	Device commands: Start Up/Downgrade	Off / ready [0]	U8
0x2022:048	Device commands: Reset Cold	Off / ready [0]	U8
0x2022:049	Device commands: Reset Origin	Off / ready [0]	U8
0x231F:001	Communication module ID: Active module ID	- (Read only)	U8
0x231F:002	Communication module ID: Module ID connected	- (Read only)	U8
0x2360	EtherCAT communication	No action/no error [0]	U8
0x2362:007	Active EtherCAT settings: Tx length	- (Read only)	U16
0x2362:008	Active EtherCAT settings: Rx length	- (Read only)	U16
0x2368	EtherCAT status	- (Read only)	U16
0x2369	EtherCAT error	- (Read only)	U16
0x2380	PROFINET communication	No action/no error [0]	U8
0x2381:001	PROFINET settings: IP address	0.0.0.0	U32
0x2381:002	PROFINET settings: Subnet	0.0.0.0	U32
0x2381:003	PROFINET settings: Gateway	0.0.0.0	U32
0x2381:004	PROFINET settings: Station name	"0"	STRING[240]
0x2381:005	PROFINET settings: I&M1 System designation	"0"	STRING[32]
0x2381:006	PROFINET settings: I&M1 Installation site	"0"	STRING[22]
0x2381:007	PROFINET settings: I&M2 Installation date	"0"	STRING[16]
0x2381:008	PROFINET settings: I&M3 additional information	"0"	STRING[54]
0x2382:001	Active PROFINET settings: IP address	- (Read only)	U32
0x2382:002	Active PROFINET settings: Subnet	- (Read only)	U32
0x2382:003	Active PROFINET settings: Gateway	- (Read only)	U32
0x2382:004	Active PROFINET settings: Station name	- (Read only)	STRING[240]
0x2382:005	Active PROFINET settings: MAC Address	- (Read only)	OCTET[6]
0x2388	PROFINET status	- (Read only)	U16
0x2389:001	PROFINET error: Error 1	- (Read only)	U16
0x2389:002	PROFINET error: Error 2	- (Read only)	U16
0x2450	Engineering port control	No action/No error [0]	U8
0x2451:001	Engineering port settings: IP address	0.0.0.0	U32
0x2451:002	Engineering port settings: Subnet	0.0.0.0	U32
0x2451:003	Engineering port settings: Gateway	0.0.0.0	U32
0x2451:004	Engineering port settings: DHCP	Disabled [0]	U8
0x2452:001	Active engineering port settings: IP address	- (Read only)	U32
0x2452:002	Active engineering port settings: Subnet	- (Read only)	U32
0x2452:003	Active engineering port settings: Gateway	- (Read only)	U32
0x2452:004	Active engineering port settings: DHCP	- (Read only)	U8
0x2452:005	Active engineering port settings: MAC address	- (Read only)	OCTET[6]
0x2459:001	Name server addresses: Name server address 1	- (Read only)	U32



Address	Name	Default setting	Data type
0x2459:002	Name server addresses: Name server address 2	- (Read only)	U32
0x245A:002	NTP server addresses: NTP server address 1	0.0.0.0	U32
0x245A:003	NTP server addresses: NTP server address 2	0.0.0.0	U32
0x245A:004	NTP server addresses: NTP server address 3	0.0.0.0	U32
0x245A:005	NTP server addresses: NTP server address 4	0.0.0.0	U32
0x245B:001	System time: Setting method	NTP server [0]	U8
0x245B:002	System time: Current time	0 ns	U64
0x245C:001	Local time: Current timezone	Unknown time zone [0]	U16
0x245C:002	Local time: Current time	0 ns	U64
0x2470:001	OPC UA server control: Restart server	No action/no error [0]	U8
0x2471:013	OPC UA server settings: Min. publishing intervall	100 ms	U32
0x2471:014	OPC UA server settings: Min. sample intervall	100 ms	U32
0x2471:051	OPC UA server settings: PLCopen model array expansion	Enabled [1]	U8
0x2471:103	OPC UA server settings: Max. number of external sessions	1	U8
0x2472:011	Active OPC UA server settings: Max. number of subscriptions	- (Read only)	U16
0x2472:012	Active OPC UA server settings: Max. number of monitored items	- (Read only)	U16
0x2472:013	Active OPC UA server settings: Min. publishing intervall	- (Read only)	U16
0x2472:014	Active OPC UA server settings: Min. sample intervall	- (Read only)	U16
0x2472:051	Active OPC UA server settings: PLCopen model array expansion	- (Read only)	U8
0x2472:103	Active OPC UA server settings: Max. number of external sessions	- (Read only)	U8
0x2473:001	OPC UA server diagnosis: State	- (Read only)	U8
0x2473:002	OPC UA server diagnosis: Error	- (Read only)	U16
0x2473:011	OPC UA server diagnosis: Used number of subscriptions	- (Read only)	U8
0x2473:012	OPC UA server diagnosis: Used number of monitored items	- (Read only)	U16
0x2473:052	OPC UA server diagnosis: PLCopen model resource utilization	x % (Read only)	U8
0x2473:053	OPC UA server diagnosis: User model resource utilization	x % (Read only)	U8
0x2473:101	OPC UA server diagnosis: Used number of engineering sessions	- (Read only)	U8
0x2473:102	OPC UA server diagnosis: Used number of system sessions	- (Read only)	U8
0x2473:103	OPC UA server diagnosis: Used number of external sessions	- (Read only)	U8
0x2473:130	OPC UA server diagnosis: Client of external session 1	- (Read only)	STRING[]
0x2473:131	OPC UA server diagnosis: Client of external session 2	- (Read only)	STRING[]
0x2473:132	OPC UA server diagnosis: Client of external session 3	- (Read only)	STRING[]
0x247B:001	OPC UA PubSub control: Activation	Disabled [0]	U8
0x247B:002	OPC UA PubSub control: Restart PubSub	No action/no error [0]	U8
0x2539:002	Hardware-Diagnose: Control board temperature	x °C (Read only)	S16
0x2539:003	Hardware-Diagnose: CPU temperature	x °C (Read only)	S16
0x2841	Reset error	0	U8
0x2859:001	PROFINET monitoring: Watchdog elapsed	Trouble [2]	U8
0x2859:002	PROFINET monitoring: Data exchange exited	No response [0]	U8
0x2859:003	PROFINET monitoring: Invalid configuration	Trouble [2]	U8
0x2859:004	PROFINET monitoring: Initialisation error	Trouble [2]	U8
0x2859:005	PROFINET monitoring: Invalid process data	Trouble [2]	U8
0x285A:001	Diagnostic configuration: Alarm suppression	0	U16
0x2D81:001	Life-diagnosis: Operating time	x s (Read only)	U32
0x2D81:002	Life-diagnosis: Power-on time	x s (Read only)	U32
0x2D81:004	Life-diagnosis: Main switching cycles	- (Read only)	U32
0x2D85:001	Fan diagnostics: Status	x % (Read only)	U8
0x2D85:002	Fan diagnostics: Speed	x rpm (Read only)	U32
0x5810:001	Application diagnostics: Application state	- (Read only)	U8
0x5810:002	Application diagnostics: Used memory size	x kB (Read only)	U32
0x5820:001	Field devices: Firmware update	Disabled [0]	U8
0x5850:001	EtherCAT master commands: Kommunikation neu starten	No action/no error [0]	U8
0x5850:002	EtherCAT master commands: Reset counters	No action/no error [0]	U16
0x5851:001	EtherCAT master diagnosis: EtherCAT master state	- (Read only)	U8
0x5851:002	EtherCAT master diagnosis: EtherCAT master state summary	- (Read only)	U32



Address	Name	Default setting	Data type
0x5851:003	EtherCAT master diagnosis: EtherCAT error	- (Read only)	U32
0x5851:004	EtherCAT master diagnosis: Bus scan match	- (Read only)	U8
0x5851:005	EtherCAT master diagnosis: Configured cycle time	x μ s (Read only)	U32
0x5851:006	EtherCAT master diagnosis: Connected slaves	- (Read only)	U32
0x5851:007	EtherCAT master diagnosis: Configured slaves	- (Read only)	U32
0x5851:008	EtherCAT master diagnosis: TX frame counter	- (Read only)	U32
0x5851:009	EtherCAT master diagnosis: Lost frame counter	- (Read only)	U32
0x5851:010	EtherCAT master diagnosis: Working counter error	- (Read only)	U32
0x5851:011	EtherCAT master diagnosis: DC slave sync deviation limit	- (Read only)	U32
0x5851:012	EtherCAT master diagnosis: DC current deviation	- (Read only)	S32
0x5851:013	EtherCAT master diagnosis: Master mode	- (Read only)	U16
0x5851:014	EtherCAT master diagnosis: Slave state summary	- (Read only)	U16
0x5851:015	EtherCAT master diagnosis: State machine	- (Read only)	U16
0x5851:030	EtherCAT master diagnosis: Connection error level	- (Read only)	U8
0x5851:031	EtherCAT master diagnosis: Error counter threshold for logging	100	U8
0x5851:032	EtherCAT master diagnosis: RX error counter	- (Read only)	U32
0x5851:033	EtherCAT master diagnosis: Processing unit error counter	- (Read only)	U32
0x5851:034	EtherCAT master diagnosis: PDI error counter	- (Read only)	U32
0x5851:035	EtherCAT master diagnosis: Lost link counter	- (Read only)	U32
0x585C:001	EtherCAT master slave information: Slave address	0	S32
0x585C:002	EtherCAT master slave information: Vendor ID	- (Read only)	U32
0x585C:003	EtherCAT master slave information: Product code	- (Read only)	U32
0x585C:004	EtherCAT master slave information: Revision	- (Read only)	U32
0x585C:005	EtherCAT master slave information: Serial number	- (Read only)	U32
0x585C:006	EtherCAT master slave information: Auto-increment address	- (Read only)	S32
0x585C:007	EtherCAT master slave information: Fixed address	- (Read only)	U16
0x585C:008	EtherCAT master slave information: Second station address	- (Read only)	U16
0x585C:010	EtherCAT master slave information: Master data link status	- (Read only)	U16
0x585C:011	EtherCAT master slave information: Master AL Status	- (Read only)	U16
0x585C:012	EtherCAT master slave information: Master RX Error Counter (Port 0-3)	- (Read only)	U64
0x585C:013	EtherCAT master slave information: Master Forwarded RX Error Counter (Port 0-3)	- (Read only)	U32
0x585C:014	EtherCAT master slave information: Master Processing Unit Error Counter	- (Read only)	U8
0x585C:015	EtherCAT master slave information: Master PDI Error Counter	- (Read only)	U8
0x585C:016	EtherCAT master slave information: Master Lost Link Counter (Port 0-3)	- (Read only)	U32
0x585C:017	EtherCAT master slave information: Master DC Sync 0 Period	- (Read only)	U32
0x585C:018	EtherCAT master slave information: Master DC Sync 1 Period	- (Read only)	U32
0x585D:001	EtherCAT master slave information: Master - Slave Address (AutoInc or Fixed)	0	S32
0x585D:002	EtherCAT master slave information: Master VendorID	- (Read only)	U32
0x585D:003	EtherCAT master slave information: Master Product code	- (Read only)	U32
0x585D:004	EtherCAT master slave information: Master Revision	- (Read only)	U32
0x585D:005	EtherCAT master slave information: Master Serial number	- (Read only)	U32
0x585D:006	EtherCAT master slave information: Master Auto-increment address	- (Read only)	S32
0x585D:007	EtherCAT master slave information: Master Fixed address	- (Read only)	U16
0x585D:008	EtherCAT master slave information: Master Second station address	- (Read only)	U16
0x585D:010	EtherCAT master slave information: Master data link status	- (Read only)	U16
0x585D:011	EtherCAT master slave information: Master AL Status	- (Read only)	U16
0x585D:012	EtherCAT master slave information: Master RX Error Counter (Port 0-3)	- (Read only)	U64
0x585D:013	EtherCAT master slave information: Master Forwarded RX Error Counter (Port 0-3)	- (Read only)	U32
0x585D:014	EtherCAT master slave information: Master Processing Unit Error Counter	- (Read only)	U8
0x585D:015	EtherCAT master slave information: Master PDI Error Counter	- (Read only)	U8
0x585D:016	EtherCAT master slave information: Master Lost Link Counter (Port 0-3)	- (Read only)	U32

Appendix

Parameter attribute list



Address	Name	Default setting	Data type
0x585D:017	EtherCAT master slave information: Master DC Sync 0 Period	- (Read only)	U32
0x585D:018	EtherCAT master slave information: Master DC Sync 1 Period	- (Read only)	U32
0x585E:001	EtherCAT master slave information: Master - Slave Address (AutoInc or Fixed)	0	S32
0x585E:002	EtherCAT master slave information: Master VendorID	- (Read only)	U32
0x585E:003	EtherCAT master slave information: Master Product code	- (Read only)	U32
0x585E:004	EtherCAT master slave information: Master Revision	- (Read only)	U32
0x585E:005	EtherCAT master slave information: Master Serial number	- (Read only)	U32
0x585E:006	EtherCAT master slave information: Master Auto-increment address	- (Read only)	S32
0x585E:007	EtherCAT master slave information: Master Fixed address	- (Read only)	U16
0x585E:008	EtherCAT master slave information: Master Second station address	- (Read only)	U16
0x585E:010	EtherCAT master slave information: Master data link status	- (Read only)	U16
0x585E:011	EtherCAT master slave information: Master AL Status	- (Read only)	U16
0x585E:012	EtherCAT master slave information: Master RX Error Counter (Port 0-3)	- (Read only)	U64
0x585E:013	EtherCAT master slave information: Master Forwarded RX Error Counter (Port 0-3)	- (Read only)	U32
0x585E:014	EtherCAT master slave information: Master Processing Unit Error Counter	- (Read only)	U8
0x585E:015	EtherCAT master slave information: Master PDI Error Counter	- (Read only)	U8
0x585E:016	EtherCAT master slave information: Master Lost Link Counter (Port 0-3)	- (Read only)	U32
0x585E:017	EtherCAT master slave information: Master DC Sync 0 Period	- (Read only)	U32
0x585E:018	EtherCAT master slave information: Master DC Sync 1 Period	- (Read only)	U32
0x585F:001	EtherCAT master slave information: Master - Slave Address (AutoInc or Fixed)	0	S32
0x585F:002	EtherCAT master slave information: Master VendorID	- (Read only)	U32
0x585F:003	EtherCAT master slave information: Master Product code	- (Read only)	U32
0x585F:004	EtherCAT master slave information: Master Revision	- (Read only)	U32
0x585F:005	EtherCAT master slave information: Master Serial number	- (Read only)	U32
0x585F:006	EtherCAT master slave information: Master Auto-increment address	- (Read only)	S32
0x585F:007	EtherCAT master slave information: Master Fixed address	- (Read only)	U16
0x585F:008	EtherCAT master slave information: Master Second station address	- (Read only)	U16
0x585F:010	EtherCAT master slave information: Master data link status	- (Read only)	U16
0x585F:011	EtherCAT master slave information: Master AL Status	- (Read only)	U16
0x585F:012	EtherCAT master slave information: Master RX Error Counter (Port 0-3)	- (Read only)	U64
0x585F:013	EtherCAT master slave information: Master Forwarded RX Error Counter (Port 0-3)	- (Read only)	U32
0x585F:014	EtherCAT master slave information: Master Processing Unit Error Counter	- (Read only)	U8
0x585F:015	EtherCAT master slave information: Master PDI Error Counter	- (Read only)	U8
0x585F:016	EtherCAT master slave information: Master Lost Link Counter (Port 0-3)	- (Read only)	U32
0x585F:017	EtherCAT master slave information: Master DC Sync 0 Period	- (Read only)	U32
0x585F:018	EtherCAT master slave information: Master DC Sync 1 Period	- (Read only)	U32
0x5901:001	Security setting HAProxy: Certificate fingerprint	- (Read only)	STRING[128]
0x5901:002	Security setting HAProxy: HTTPS redirect	- (Read only)	U8
0x5910:001	Firewall: Activation	Deactivated [0]	U8
0x5910:002	Firewall: IP range 1 start	0	U32
0x5910:003	Firewall: IP range 1 end	0	U32
0x5910:004	Firewall: IP range 2 start	0	U32
0x5910:005	Firewall: IP range 2 end	0	U32
0x5910:006	Firewall: IP range 2 start	0	U32
0x5910:007	Firewall: IP range 3 end	0	U32
0x5910:008	Firewall: IP range 4 start	0	U32
0x5910:009	Firewall: IP range 4 end	0	U32
0x5911:001	Well-known ports: Secure Shell (SSH): Network	0	U8
0x5911:002	Well-known ports: Secure Shell (SSH): Client IP range	Any [0]	U16
0x5911:003	Well-known ports: Secure Shell (SSH): Activation	Drop [0]	U16



Address	Name	Default setting	Data type
0x5911:031	Well-known ports: Network Time Protocol (NTP): Network	0	U8
0x5911:032	Well-known ports: Network Time Protocol (NTP): Client IP range	Any [0]	U16
0x5911:033	Well-known ports: Network Time Protocol (NTP): Activation	Drop [0]	U16
0x5911:051	Well-known ports: Hypertext Transfer Protocol Secure (HTTPS): Network	0	U8
0x5911:052	Well-known ports: Hypertext Transfer Protocol Secure (HTTPS): Client IP range	Any [0]	U16
0x5911:053	Well-known ports: Hypertext Transfer Protocol Secure (HTTPS): Activation	Drop [0]	U16
0x5912:001	Registered ports: PLC Designer TCP gateway search: Network	0	U8
0x5912:002	Registered ports: PLC Designer TCP gateway search: Client IP range	Any [0]	U16
0x5912:003	Registered ports: PLC Designer TCP gateway search: Activation	Drop [0]	U16
0x5912:011	Registered ports: PLC Designer UDP communication: Network	0	U8
0x5912:012	Registered ports: PLC Designer UDP communication: Client IP range	Any [0]	U16
0x5912:013	Registered ports: PLC Designer UDP communication: Activation	Drop [0]	U16
0x5912:031	Registered ports: Lenze specific device-search (ESDCP): Network	0	U8
0x5912:032	Registered ports: Lenze specific device-search (ESDCP): Client IP range	Any [0]	U16
0x5912:033	Registered ports: Lenze specific device-search (ESDCP): Activation	Drop [0]	U16
0x5912:041	Registered ports: OPC UA server: Network	0	U8
0x5912:042	Registered ports: OPC UA server: Client IP range	Any [0]	U16
0x5912:043	Registered ports: OPC UA server: Activation	Drop [0]	U16
0x5912:051	Registered ports: EtherCAT master diagnostic tool: Network	0	U8
0x5912:052	Registered ports: EtherCAT master diagnostic tool: Client IP range	Any [0]	U16
0x5912:053	Registered ports: EtherCAT master diagnostic tool: Activation	Drop [0]	U16
0x5912:061	Registered ports: UI designer RAW: Network	0	U8
0x5912:062	Registered ports: UI designer RAW: Client IP range	Any [0]	U16
0x5912:063	Registered ports: UI designer RAW: Activation	Drop [0]	U16
0x5912:071	Registered ports: UI designer secure RAW: Network	0	U8
0x5912:072	Registered ports: UI designer secure RAW: Client IP range	Any [0]	U16
0x5912:073	Registered ports: UI designer secure RAW: Activation	Drop [0]	U16
0x5912:091	Registered ports: PLC Designer gateway: Network	0	U8
0x5912:092	Registered ports: PLC Designer gateway: Client IP range	Any [0]	U16
0x5912:093	Registered ports: PLC Designer gateway: Activation	Drop [0]	U16
0x5912:101	Registered ports: Lenze specific engineering access (SFTP/SCP): Network	0	U8
0x5912:102	Registered ports: Lenze specific engineering access (SFTP/SCP): Client IP range	Any [0]	U16
0x5912:103	Registered ports: Lenze specific engineering access (SFTP/SCP): Activation	Drop [0]	U16
0x5912:131	Registered ports: SFTP/SCP: Network	0	U8
0x5912:132	Registered ports: SFTP/SCP: Client IP range	Any [0]	U16
0x5912:133	Registered ports: SFTP/SCP: Activation	Drop [0]	U16
0x5912:151	Registered ports: OPC UA PubSub (UADP): Network	0	U8
0x5912:152	Registered ports: OPC UA PubSub (UADP): Client IP Range	Any [0]	U16
0x5912:153	Registered ports: OPC UA PubSub (UADP): Activation	- (Read only)	U16
0x5913:001	Application ports: Application port 1: Network	0	U8
0x5913:002	Application ports: Application port 1: Client IP range	Any [0]	U16
0x5913:003	Application ports: Application port 1: Activation	Drop [0]	U16
0x5913:007	Application ports: Application port 1: Protocol type	None [0]	U16
0x5913:008	Application ports: Application port 1: Port range start	0	U16
0x5913:009	Application ports: Application port 1: Port range end	0	U16
0x5913:010	Application ports: Application port 1: Protocol name	"0"	STRING[]
0x5913:011	Application ports: Application port 2: Network	0	U8
0x5913:012	Application ports: Application port 2: Client IP range	Any [0]	U16
0x5913:013	Application ports: Application port 2: Activation	Drop [0]	U16
0x5913:017	Application ports: Application port 2: Protocol type	None [0]	U16



Address	Name	Default setting	Data type
0x5913:018	Application ports: Application port 2: Port range start	0	U16
0x5913:019	Application ports: Application port 2: Port range end	0	U16
0x5913:020	Application ports: Application port 2: Protocol name	"0"	STRING[]
0x5913:021	Application ports: Application port 3: Network	0	U8
0x5913:022	Application ports: Application port 3: Client IP range	Any [0]	U16
0x5913:023	Application ports: Application port 3: Activation	Drop [0]	U16
0x5913:027	Application ports: Application port 3: Protocol type	None [0]	U16
0x5913:028	Application ports: Application port 3: Port range start	0	U16
0x5913:029	Application ports: Application port 3: Port range end	0	U16
0x5913:030	Application ports: Application port 3: Protocol name	"0"	STRING[]
0x5913:031	Application ports: Application port 4: Network	0	U8
0x5913:032	Application ports: Application port 4: Client IP range	Any [0]	U16
0x5913:033	Application ports: Application port 4: Activation	Drop [0]	U16
0x5913:037	Application ports: Application port 4: Protocol type	None [0]	U16
0x5913:038	Application ports: Application port 4: Port range start	0	U16
0x5913:039	Application ports: Application port 4: Port range end	0	U16
0x5913:040	Application ports: Application port 4: Protocol name	"0"	STRING[]

